



# KING TONY

# 2025

ES  
€

*Enjoy your work*



# OFERTAS

# Valores de la marca

Desde 1984, KING TONY® suministra herramientas para profesionales. Nos focalizamos en tener ofertas de calidad para responder a las exigencias de nuestra clientela. Cada mecánico desea acabar una tarea con un resultado profesional. Y acabarla sin esfuerzo y de forma rápida todavía complace más. Así fabricamos nuestra herramienta en KING TONY®, pensando en el mecánico que la usará para acabar su trabajo rápido, sin esfuerzo y con resultados que superan lo esperado. « Enjoy your work\* », gracias al diseño, la comodidad, resistencia y calidad de nuestros productos. Elige KING TONY® y cambia tu visión del trabajo.



• Quality • Innovation • Health • Enjoyment™

\*Enjoy your work = ¡Disfruta de tu trabajo!

\*\*Quality, Innovation, Health, Enjoyment = Calidad, Innovación, Bien estar, Placer

# Diseño patentado

Nuestro sistema patentado de identificación con colores es precursor en el mundo de la herramienta. Para que reconozcas tu vaso a primera vista, KING TONY® ha elegido dos colores: AZUL para las medidas en métrico, ROJO para las pulgadas.



# Dimensiones exactas

Somos conscientes de la importancia que es para un profesional tener dimensiones precisas. KING TONY® utiliza sus conocimientos como fabricante para reducir al máximo la tolerancia de sus herramientas.



# Innovaciones

Cada año mejoramos nuestra herramienta. KING TONY® selecciona sus ideas más ingeniosas para el desarrollo de nuevos productos respetando calidad profesional con precio competitivo. Para nuestros nuevos diseños, siempre nos focalizamos en la comodidad, seguridad y rendimiento de nuestros usuarios.



1062 SERIES I-BEAM technology

# Exigencia calidad

Solo salen de nuestra fábrica las mejores piezas. KING TONY® tiene su propia normativa y supera la normativa DIN del 30% como mínimo para su herramienta de mano y del 50% como mínimo para su gama de impacto.



Prueba del punto de rotura de las llaves combinadas de 13, 17 y 19 mm KING TONY®. Comparación con la normativa DIN 3113. Prueba realizada por CETIM (organismo privado).

# Patrocinio y acuerdos

Pilotos apasionados de mecánica,  
eligieron KING TONY® para  
acompañarles en sus tareas  
diarias.



**Charlie Herbst  
HC RACING 86**



**Kevin Rohrscheidt - KEEPONRACING**



KING TONY® desarrolla su imagen de marca a través de deportes de motor, y eso a nivel internacional. Es otra manera que hemos encontrado para aumentar nuestra visibilidad.

# Una imagen de marca potente

**TATI Team  
Beringer Racing**



KING TONY® decidió ser especialista en herramienta profesional, convirtiéndose en «experta en herramientas y servicio». Además, con su estrategia marketing, da apoyo a sus clientes sin perderles nunca de vista.



**Bonduel Racing ASBL**



**Romain Dumas - RD Limited**

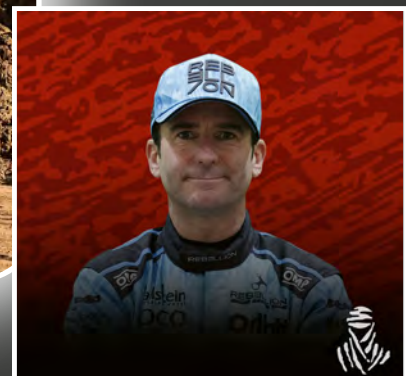

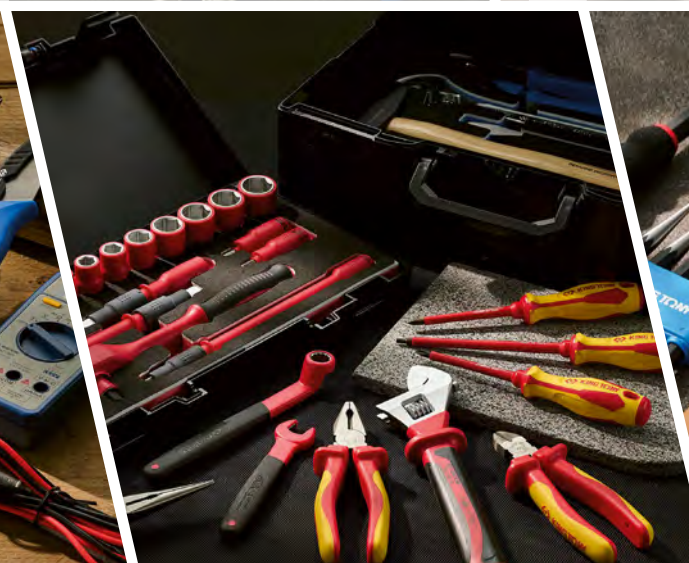
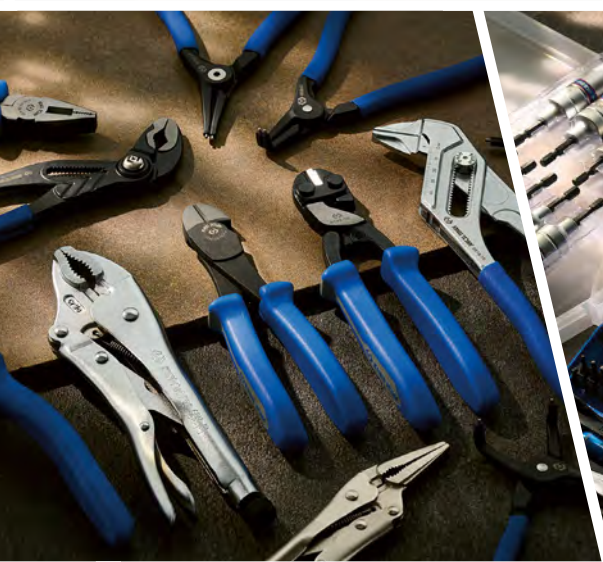
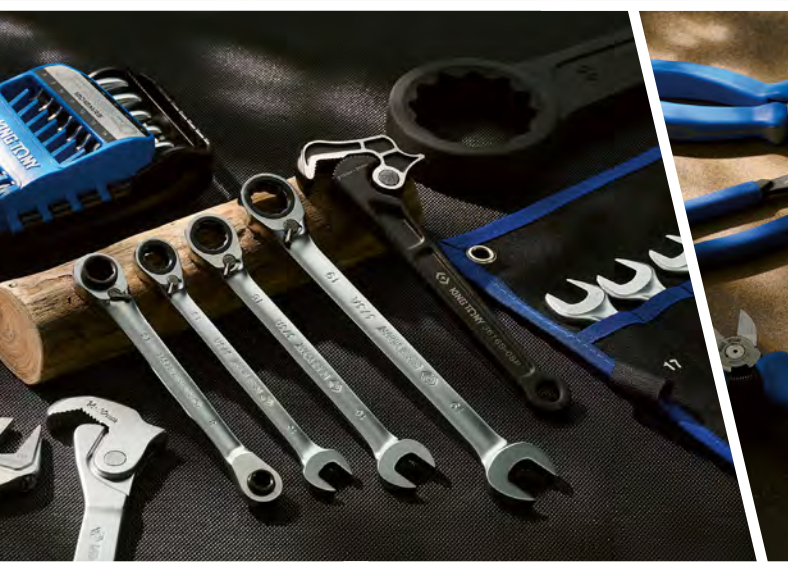

# ÍNDICE

Vasos .....	8
Vasos de impacto .....	20
Llaves de impacto neumáticas .....	24
Llaves .....	26
Alicates .....	33
Destornilladores, llaves macho y puntas .....	38
Herramientas de tubería .....	46
Herramientas para electricista .....	48
Herramientas con aislamiento 1000V .....	55
 <b>PENTA</b> Equipos de seguridad eléctrica .....	58
Martillos y herramientas de golpe .....	62
Herramientas para taller .....	66
Iluminación .....	70
Mobiliario y composiciones de herramientas .....	74
Apriete controlado .....	112
Extractores .....	116
Mecánica .....	124
Hidráulica - Elevación .....	140



# CARRACAS Y EMPUÑADURAS ARTICULADAS

## CARRACAS

- Materiales:
  - Cuerpo de Cr-V
  - Cuadrado conductor de Cr-Mo

- Acabado:
  - Cuerpo cromado pulido
  - Cuadrado conductor fosfato negro

supera del **30%** como mín. normativas DIN



**48 dientes**  
7°

15°

95

**2746 72 mm 1/4" 24€<sup>B</sup>**

**CARRACA PORTA PUNTA «PALMA DE MANO» 1/4"**



Liberación rápida del vaso

1/4" **MINI CARRACA**

2 PZAS

**276B0225 87.6 mm 32€<sup>B</sup>**

**JUEGO DE MINI CARRACA PORTA PUNTAS Y PORTA VASOS 1/4"**

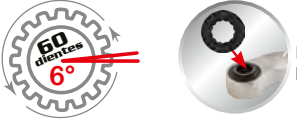

**60 dientes**  
6°

Porta puntas bi-hexagonal

Contiene

276B35

770225

80



Liberación rápida del vaso

1/4"

**275245G 114 mm 31€<sup>B</sup>**

**MINI CARRACA CON MANGO ARTICULADO Y CABEZA GIRATORIA**



**72 dientes**  
5°

Mango abatible que permite una utilización en T.



1/4"

**276955P 140 mm 22€<sup>B</sup>**

**CARRACA REVERSIBLE**

24 dientes 15°

125



24 dientes 15°

**877932F 800 mm 1" 199€<sup>B</sup>**

**CARRACA REVERSIBLE**

4,40



**90 dientes**  
4°

**IP51**

Protección contra las infiltraciones de polvo y de condensación

Liberación rápida del vaso

Bola de retención de acero

Reversible

Diseño I-beam

Mango PP+TPR antideslizante

2 PZAS

**7773GS 56€<sup>B</sup>**

**JUEGO DE CARRACAS DE 1/2" Y 1/4" I-BEAM RESISTENTE AL POLVO**

**277355GS 140 mm 30€<sup>B</sup>**

1/4" 110

**477310GS 250 mm 34€<sup>B</sup>**

1/2" 500

**CARRACAS REVERSIBLES**



**72 dientes**  
5°

**275555G 140 mm 31€<sup>B</sup>**

1/4" 120

**375508G 200 mm 28€<sup>B</sup>**

3/8" 387

**475510G 250 mm 31€<sup>B</sup>**

1/2" 570

**CARRACAS REVERSIBLES**



Liberación rápida del vaso

**24 dientes**  
15°

**377108G 200 mm 34€<sup>B</sup>**

3/8" 309

**477110G 250 mm 32€<sup>B</sup>**

1/2" 623



Liberación rápida del vaso

**24 dientes**  
15°

**677820FS 500 mm 3/4" 97€<sup>B</sup>**

**CARRACA REVERSIBLE**

2,61







Ultra resistente



Telescópico



Liberación rápida del vaso



Bola de retención de acero

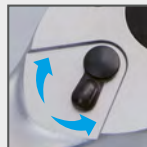

Reversible



Mango PP+TPR antideslizante

**477322GS** 89€ B

**CARRACA TELESCÓPICA 1/2"**

Mayor par, con menos esfuerzo gracias a la extensión: máx. 550 mm. Capacidad de carga máxima de 700 Nm, muy por encima de la norma de calidad.



1.28



Protección contra las infiltraciones de polvo y de condensación

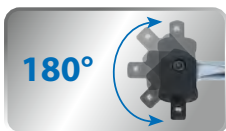

**446124G** 450 ~ 600 mm 1/2" 46€ B

**EMPUÑADURA ARTICULADA Y EXTENSIBLE**

1.18



**646240P** 1020 mm 3/4" 119€ B

**EMPUÑADURAS ARTICULADAS**

3.90

**846240P** 1020 mm 1" 134€ B

3.95



**I-beam**

**445315F** 375 mm 1/2" 29€ B

630

**445318F** 450 mm 1/2" 33€ B

708

**EMPUÑADURAS ARTICULADAS**



Cabeza reforzada en forma de U



Cuadrado giratorio a 180°



Bola de retención de acero



Diseño I-Beam

**New**

3 PZAS



**9403PP** 35,60€ B

**JUEGO DE AUMENTADORES MAGNÉTICOS EXTRAFINOS**

0.15

Ideal cuando el espacio es limitado o un adaptador normal no es apropiado. Adaptadores con imanes para sujetar firmemente las tomas. Diseño extraplano (un 20% menos que un modelo estándar).



Contiene	L mm
2883 1/4" F x 3/8" M	14,5
3884 3/8" F x 1/2" M	19
4886 1/2" F x 3/4" M	28

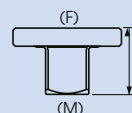



6  
PZAS

78106 29€<sup>B</sup>

**COFRE DE ADAPTADORES  
1/4", 3/8", 1/2" Y 3/4"**

Contiene	F	M
2813	1/4" →	3/8"
4813	1/2" →	3/8"
3812	3/8" →	1/4"
4816	1/2" →	3/4"
3814	3/8" →	1/2"
6814	3/4" →	1/2"

1.31



2793 31 mm 10€<sup>B</sup>

**ARTICULACIÓN 1/4"**

18

4793 59 mm 10€<sup>B</sup>

**ARTICULACIÓN 1/2"**

125

Ángulo de 20°  
Modelo corto que permite un acceso en los espacios estrechos  
Acabado cromado pulido  
Bloqueo hexagonal de bola.

**EXTENSIONES**



229304 100 mm 1/4" 6,50€<sup>B</sup>

45

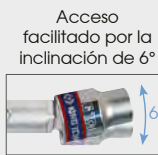

229306 150 mm 1/4" 7,70€<sup>B</sup>

140



625104 100 mm 3/4" 14,80€<sup>B</sup>

400

625108 200 mm 3/4" 20,90€<sup>B</sup>

730

625116 400 mm 3/4" 29,70€<sup>B</sup>

1.36



422118 450 mm 1/2" 18,50€<sup>B</sup>

550

422124 600 mm 1/2" 22€<sup>B</sup>

680

422130 750 mm 1/2" 32€<sup>B</sup>

860

422136 900 mm 1/2" 34€<sup>B</sup>

1.03

**New**



3  
PZAS

3893EW 340 mm 1/4" 3/8" 89€<sup>B</sup>

**ALARGADOR PARA CARRACAS DE 1/4" Y 3/8"**

La extensión facilita el trabajo en espacios reducidos. Se suministra con dos escuadras intercambiables de 1/4" y 3/8".

El mecanismo accionado por cadena mejora la durabilidad y la suavidad de funcionamiento.

Diseñado para alejarse de la zona de trabajo, lo que facilita el apriete o afloje.

Par de apriete máximo: 130 Nm (96 ft lb).

410

**VASOS Y RAÍLES DE VASOS**

**GARANTÍA ILIMITADA**

CROMO VANADIO



Anillo de goma en todos los vasos 1/2", 3/4" y 1"



MÉTRICAS

Supera del **30%** como mín. normativas DIN



PULGADAS

Normativas ANSI

**PIÉNSELO!**



11  
PZAS

91000M 17,50€<sup>B</sup>

**JUEGO DE INSERTOS MAGNÉTICOS HEXAGONALES PARA VASOS MÉTRICOS**

42



Para vasos métricos hexagonales o bi hexagonales.

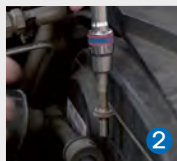

22  
PZAS



P91000M 54€<sup>B</sup>

790

4335M : 8, 10, 11, 12, 13, 14, 15, 16, 17, 18, 19

+ 91000M : 8, 10, 11, 12, 13, 14, 15, 16, 17, 18, 19



2330S : 5/32", 3/16", 7/32", 1/4", 9/32", 5/16", 11/32", 3/8", 7/16", 15/32", 1/2"

**2011SR**

**11** PZAS

19€<sup>B</sup>

620



2033 : T8, T9, T10, T15, T20, T25, T27, T30, T40

**2109PR**

**9** PZAS

18€<sup>B</sup>

170



2033 : T8, T9, T10, T15, T20, T25, T27, T30, T40 - 2275M : E4, E5, E6, E7, E8

**2114TR**

**14** PZAS

26€<sup>B</sup>

300



2035 : H3, H4, H5, H6, H7, H8, H10

**2127PR**

**7** PZAS

14€<sup>B</sup>

150



2035S : H1/8, H5/32, H3/16, H7/32, H1/4, H5/16, H3/8

**2127SR**

**7** PZAS

16€<sup>B</sup>

150



2335M : 4, 5, 6, 7, 8, 9, 10, 11, 13

**2509MR**

**9** PZAS

11,60€<sup>B</sup>

200



3023 : T15, T20, T25, T27, T30, T40, T45, T50

**3118PR**

**8** PZAS

36€<sup>B</sup>

340



3375M : E4, E5, E6, E7, E8, E11 - 4375M : E10, E12, E14, E16, E18, E20

**7113PR**

**12** PZAS

40€<sup>B</sup>

350



4330S : 3/8", 7/16", 1/2", 9/16", 11/16", 3/4", 13/16", 7/8"

**4010SR**

**8** PZAS

26€<sup>B</sup>

640



402B : M16 - 4026 : M8, M10, M12, M14

**4105PR**

**5** PZAS

37€<sup>B</sup>

570



4025 : H6, H7, H8, H10, H12, H14, H17, H19

**4108PR10**

**8** PZAS

41€<sup>B</sup>

960



4335M : 10, 12, 13, 14, 17, 19, 21, 22

**4510MR**

**8** PZAS

25€<sup>B</sup>

640



4049 : M9, M10, M12, M13, M14, M16

**4116PR**

**6** PZAS

67€<sup>B</sup>

380



DIN 3120

**6023**

		L mm		
602360	60	80	250	16€ <sup>B</sup>
602370	70	80	255	16€ <sup>B</sup>
602380	80	80	320	22€ <sup>B</sup>
602390	90	80	330	23€ <sup>B</sup>
6023A0	100	80	349	23€ <sup>B</sup>



DIN 7422

**6025**

		L mm		
602514	H14	80	258	12,50€ <sup>B</sup>
602517	H17	80	269	12,50€ <sup>B</sup>
602519	H19	80	278	12,50€ <sup>B</sup>
602522	H22	80	359	14,50€ <sup>B</sup>



DIN 3124

**6235M**

		L mm		
623549M	49	95	1035	34,70€ <sup>B</sup>
623555M	55	95	1153	57,60€ <sup>B</sup>
623560M	60	100	1662	73,30€ <sup>B</sup>
623565M	65	100	1613	73,30€ <sup>B</sup>
623570M	70	100	1766	73,30€ <sup>B</sup>

Descubra toda la serie 6235M  
17 mm → 70 mm



DIN 3124

**6330M**

		L mm		
633029M	29	52	261	11,90€ <sup>B</sup>
633050M	50	72	889	23,90€ <sup>B</sup>

Descubra toda la serie 6235M  
17 mm → 70 mm



# COFRES DE VASOS

CROMO VANADIO



Anillo de goma en todos los vasos 1/2", 3/4" y 1"

MÉTRICAS

Supera del **30%** como mín. normativas DIN

PULGADAS

Normativas ANSI



25 PZAS

**2525MRE** 1/4"

38,20€<sup>B</sup>

203 x 93 x 43 mm

Contiene 0.55

- 2335M 4, 4.5, 5, 5.5, 6, 7, 8, 9, 10, 11, 12, 13
- 1025P PH2, PH2
- 1025H H5, H6
- 1025T T10, T15, T20, T25, T30, T40
- 2142 222104
- 277155G



26 PZAS

**2526SR02** 1/4"

72€<sup>B</sup>

244 x 118 x 37 mm

Contiene 1.38

- 2335S 5/32", 3/16", 7/32", 1/4", 9/32", 5/16", 11/32", 3/8", 7/16", 15/32", 1/2"
- 2235S 5/32", 3/16", 7/32", 1/4", 9/32", 5/16", 11/32", 3/8", 7/16", 1/2"
- 222102, 222104
- 275555G 2792 2813



31 PZAS

**2531MR03** 1/4"

87€<sup>B</sup>

280 x 130 x 41 mm

Contiene 1.60

- 2335M 4, 4.5, 5, 6, 7, 8, 9, 10, 11, 12, 13
- 2033 T8, T9, T10, T15, T20, T25, T27, T30
- 2035 H3, H4, H5, H6, H8, H10
- 275555G 257145
- 2792 2179DF
- 222103, 222106



39 PZAS

**2539MRV04** 1/4"

69€<sup>B</sup>

199 x 161 x 56 mm

Contiene 1.25

- 2335M 5, 6, 7, 8, 9, 10, 11, 12, 13, 14
- 1025S 4.0 x 0.5, 5.5 x 0.8, 6.5 x 1.2
- 1025P PH1, PH2
- 1025Z PZ2
- 1025U T7H, T8H, T9H, T10H, T15H, T20H, T25H, T27H, T30H, T40H
- 1025H H1.5, H2, H2.5, H3, H4, H5, H6
- 1317012PN PH1 PH2
- 1317046SN 4.0 6.0
- 1317057SN 5.0 7.0
- 770225 215506
- 2155DF



39 PZAS

Serie ATOM



IP51 I-beam

**2539MR01AM** 1/4"

78€<sup>B</sup>

175 x 98.5 x 55 mm

Contiene 0.86

- 2335M 5, 5.5, 6, 7, 8, 9, 10, 11, 12, 13, 14
- 1025P PH1, PH2, PH3
- 102512P PH2
- 1025Z PZ1, PZ2, PZ3
- 1025T T10, T15, T20, T25, T27, T30, T40
- 1025S 4.0, 5.0, 6.0
- 1025H H2.5, H3, H4, H5, H6
- (H-beam) 277355GS
- 2176DF
- 2141 2793 222102, 222104



44 PZAS

**2044SRE** 1/4"

109€<sup>B</sup>

**2544SRE** 1/4"

84€<sup>B</sup>

CANTIDAD LIMITADA

Cofre 820002K (389 x 185 x 66 mm)  
EVA #10 (375 x 140 mm)

Contiene 1.62

- 2044SRE 2330S 5/32", 3/16", 7/32", 1/4", 9/32", 5/16", 11/32", 3/8", 7/16", 15/32", 1/2"
- 2544SRE 2335S 5/32", 3/16", 7/32", 1/4", 9/32", 5/16", 11/32", 3/8", 7/16", 15/32", 1/2"
- 2235S 5/32", 3/16", 7/32", 1/4", 9/32", 5/16", 11/32", 3/8", 7/16", 1/2"
- 5025H H3/64", H1/16", H5/64", H3/32", H7/64", H1/8", H9/64", H5/32"
- 1025S 3.0, 4.5, 5, 6.5, 8
- 1025P PH0, PH1, PH2, PH3
- 222302, 222304
- 275206G 2792 2142
- 2178DF

\*Garantía ilimitada, excluyendo las puntas 1/4".



**New**

47  
PZAS

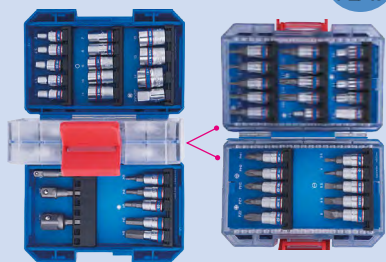

**2547MREB**

1/4"

82€<sup>B</sup>

150 x 106 x 83 mm

CAJA DE VASOS 1/4" MÉTRICOS

Contiene		1.0
	2335M 4, 4.5, 5, 5.5, 6, 7, 8, 9, 10, 11, 12, 13, 14	
	2375M E4, E5, E6, E7, E8, E10	
	2031 PH1, PH2, PH3	
	2032 3.5, 4, 5.5, 6.5, 8	
	2033 T8, T9, T10, T15, T20, T25, T27, T30, T40	
	2035 H3, H4, H5, H6, H8	
	2038 PZ1, PZ2	
	2813 1/4" F x 3/8" M	
	770250 1/4"	
	770350 3/8"	
	770450 1/2"	

**New**

**2551MR03**

1/4"

84€<sup>B</sup>

CAJA DE VASOS MÉTRICOS Y ACCESORIOS 1/4"



244 x 118 x 37 mm

51  
PZAS

Contiene		1.3
	2335M 4, 4.5, 5, 5.5, 6, 7, 8, 9, 10, 11, 12, 13, 14	
	1025S 3.0, 4.0, 5.0, 6.0	
	1025P PH1, PH2, PH2, PH3	
	1025Z PZ1, PZ2, PZ2, PZ3	
	1025T T10, T15, T20, T25, T27, T30, T40	
	1025U T10H, T15H, T20H, T25H, T27H, T30H, T40H	
	1025H H3, H4, H5, H6	
	222302, 222304	
	275555G 2176DF	
	2792 770225 75363 2813	



**2572MRE**

1/4"

164€<sup>B</sup>

Cofre 820003K (389 x 230 x 66 mm)  
EVA #8 (375 x 187 mm)

72  
PZAS

Contiene		2.06
	2335M 4, 5, 6, 7, 8, 9, 10, 11, 12, 13, 14	
	2235M 6, 7, 8, 9, 10, 11, 12, 13	
	2375M E4, E5, E6, E7, E8	
	2033 T8, T9, T10, T15, T20, T25, T27, T30, T40	
	2035 H3, H4, H5, H6	
	2037 T20, T25, T30, T40	
	1025P PH0, PH1, PH2, PH3	
	1025Z PZ1, PZ2, PZ3	
	1025H H3, H4, H5, H6	
	1025T T10, T15, T20, T25, T27, T35, T40	
	1025U T15H, T20H, T25H, T27H, T30H, T40H	
	222302, 222304	
	277355GS H-beam 2746	
	2178DF 2792 2142	



**5092CR**

1/4"

3/8"

199€<sup>B</sup>

445 x 187 x 50 mm

91  
PZAS

Contiene		4.4
	2335M 4, 4.5, 5, 5.5, 6, 7, 8, 9, 10, 11, 12, 13	
	2335S 5/32", 3/16", 7/32", 1/4", 9/32", 5/16", 11/32", 3/8", 7/16", 1/2"	
	2235M 4, 4.5, 5, 5.5, 6, 7, 8, 9, 10, 11, 12, 13	
	2235S 5/32", 3/16", 7/32", 1/4", 9/32", 5/16", 11/32", 3/8", 7/16", 1/2"	
	3330M 8, 9, 10, 11, 12, 13, 14, 15, 16, 17, 18, 19, 20, 21, 22	
	2015SX 1/8, 3/16, 7/32, 1/4, 5/16, 3/8	
	2015MX H3, H4, H5, H6, H8, H10	
	2011X PH1, PH2, PH3, PH4	
	1115 H1.5, H2, H2.5 2561	
	376908F 257145 245205F 2179DF 3792	
	3812 363516 222102, 222104 322103, 322106 3840	

**New**

48  
PZAS

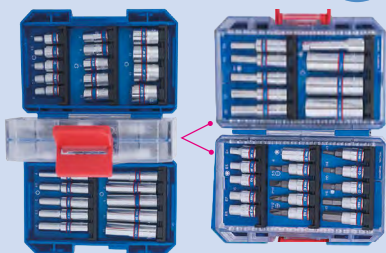

**2549MREB**

1/4"

94€<sup>B</sup>

150 x 106 x 83 mm

CAJA DE VASOS 1/4" MÉTRICOS

Contiene		1.28
	2335M 4, 4.5, 5, 5.5, 6, 7, 8, 9, 10 (x2), 11, 12, 13, 14	
	2235M 4, 4.5, 5, 5.5, 6, 7, 8, 9, 10, 11, 12, 13, 14	
	2275M E4, E5, E6, E7, E8	
	2375M E4, E5, E6, E7, E8, E10	
	2031 PH1, PH2	
	2032 4, 5.5	
	2035 H3, H4, H5, H6, H8	
	222102	



**3534MR01**

3/8"

115€<sup>B</sup>

372 x 153 x 40 mm

Contiene		3.1
	3335M 6, 7, 8, 9, 10, 11, 13, 14, 17, 19	
	3375M E4, E5, E6, E7, E8, E10, E12, E14, E16, E18	
	3023 T8, T9, T10, T15, T20, T25, T27, T30, T40, T45	
	375508G 3452 3792	
	357108 322103, 322106	



**3523MRE09**

3/8"

99€<sup>B</sup>

Cofre 820002K (389 x 185 x 66 mm)  
EVA #10 (375 x 140 mm)

Contiene		2.43
	3335M 6, 7, 8, 9, 10, 11, 12, 13, 14, 15, 16, 17, 19, 21, 22, 23, 24	
	375508G	
	329303, 329306	
	445215F 3792	
	345208G 357108	

\*Garantía ilimitada, excluyendo las puntas 1/4".

Oferta válida del 01/01/2025 al 31/12/2025. Precio recomendado de venta al público en euros sin IVA. Fotos no contractuales.



20 PZAS

**7120PR** 3/8" 1/2" **63€** <sup>B</sup>

296 x 130 x 41 mm

Contiene		6.24
	3375M E6, E7, E8, E10	
	4375M E12, E14, E16, E18, E20	
	3023 T10, T15, T20, T25, T27	
	4023 T30, T40, T45, T50, T55	
	4813	



60 PZAS

**7560MRE** 1/4" 1/2" **263€** <sup>B</sup>

**7560MRE01** 1/4" 1/2" **263€** <sup>B</sup>

Cofre 820011K (422 x 372 x 92mm)  
EVA #9 (375 x 280 mm)

Contiene		6.24
	2335M 4, 5, 5.5, 6, 7, 8, 9, 10, 11, 12, 13, 14	
	4335M 10, 11, 13, 14, 15, 16, 17, 18, 19, 20, 21, 22, 24, 27, 30, 32	
	1025S 3, 4.5, 5, 6.5, 8	
	1025P PH0, PH1, PH2, PH3	
	1025Z PZ1, PZ2, PZ3	
	1025U T10, T15, T20, T25, T27, T30, T40	
	222302, 222304	
	425105, 425106	2745
	<b>7560MRE</b>	475510G
	<b>7560MRE01</b>	477110G
	276A04G	213312DF
	445215F	457212
	2813	2792 4791 2142



62 PZAS

**9564MR01** 1/4" 3/8" 1/2" **268€** <sup>B</sup>

476 x 282 x 57 mm

Contiene		7.45
	4335M 12, 13, 14, 15, 16, 17, 18, 19, 20, 21, 22, 23, 24, 27, 30, 32	
	3335M 8, 9, 10, 11, 12, 13, 14, 15, 17, 19	
	2335M 4, 4.5, 5, 6, 7, 8, 9, 10, 11, 12	
	3235M 10, 13, 17, 19	
	3375M E10, E12, E14, E16, E18	
	3023 T20, T25, T27, T30, T40	
	3665 16, 20.8	
	425106	222104
	475510G	375508G 275555G 457212
	2792	3792 4791



\*Garantía ilimitada, excluyendo las puntas 1/4".

Oferta válida del 01/01/2025 al 31/12/2025. Precio recomendado de venta al público en euros sin IVA. Fotos no contractuales.

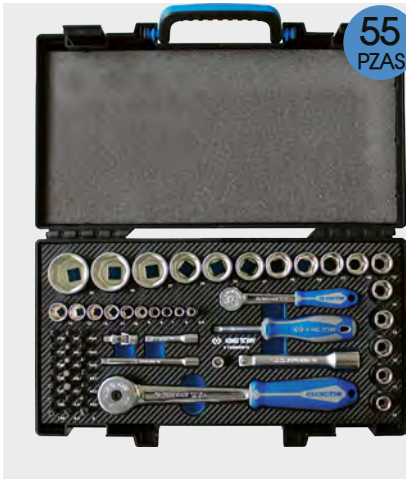

55  
PZAS

**7555MRE10** 1/4" 1/2" 168€<sup>B</sup>

Cofre 820003K (389 x 230 x 66 mm)  
EVA #8 (375 x 187 mm)

Contiene		3.80
2335M	5.5, 6, 7, 8, 9, 10, 11, 12, 13, 14	
4335M	10, 11, 12, 13, 14, 15, 16, 17, 18, 19, 21, 22, 24, 27, 30, 32	
1025S	4.5, 6.5, 8	
1025P	PH1, PH2, PH3	
1025Z	PZ1, PZ2, PZ3	
1025U	T10, T15, T20, T25, T27, T30, T40	
1025H	H3, H4, H5, H6, H7	
275555G	475510G	
2178DF	2792 2142	
222102, 222104	422305	



Bandeja Evawave que se adapta a los cajones de los carros



81  
PZAS

**7581MRO1** 1/4" 1/2" 316€<sup>B</sup>

422 x 360 x 110 mm

Contiene		7.14
2335M	4, 4.5, 5, 5.5, 6, 7, 8, 9, 10, 11, 12, 13	
4335M	10, 11, 12, 13, 14, 15, 17, 19, 22, 24	
4635	16, 20, 8	
1025H	H3, H4, H5, H6, H7, H8	
1025T	T20, T25, T30, T40	
1060	6, 7, 8, 10, 12, 13, 14, 15, 17, 19	
1120MR	H1.5, H2, H2.5, H3, H4, H5, H6, H8, H10	
1147R	T10H, T15H, T20H, T25H, T27H, T30H, T40H	
1421	PH1 x 80, PH2 x 100	
1422	4 x 100, 5.5 x 125, 6.5 x 150	
276A04G	475510G	
222104	425105	
2792	4791 75060	
631106	611106	
651610C		
7610405	7621505 7640406	
782150OS	79831	
9DC22		



110  
PZAS

**7511MR** 1/4" 1/2" 244€<sup>B</sup>

422 x 275 x 85 mm

Contiene		6.9
2335M	4, 4.5, 5, 5.5, 6, 7, 8, 9, 10, 11, 12, 13, 14	
2235M	6, 7, 8, 9, 10, 11, 12, 13	
2375M	E4, E5, E6, E7, E8	
4235M	14, 15, 17, 19, 22	
4335M	10, 11, 12, 13, 14, 15, 16, 17, 18, 19, 20, 21, 22, 24, 27, 30, 32	
4375M	E10, E11, E12, E14, E16, E18, E20, E24	
4635	16, 20, 8	
2031	PH1, PH2	2038 PZ1, PZ2
2032	4, 5.5, 6.5	
2033	T8, T10, T15, T20, T25, T27, T30	
2035	H3, H4, H5, H6	
1836P	PH3, PH4	1836H H14
1836S	8x1.2, 10x1.6, 12x2.0	
1832T	T40, T45, T50, T55, T60	
1832H	H7, H8, H10, H12	
1836Z	PZ3, PZ4	
1125M	1.5, 2, 2.5	
277155G	477110G	
2745	2178DF 2792 4791	
222102, 222104	425105	
4222	3824	
770225	414810S	



103  
PZAS

**7503MRO1** 1/4" 1/2" 358€<sup>B</sup>

422 x 360 x 110 mm

Contiene		9.24
2335M	4, 4.5, 5, 5.5, 6, 7, 8, 9, 10	
4335M	8, 9, 10, 11, 12, 13, 14, 15, 16, 17, 18, 19, 20, 21, 22, 23, 24, 27, 30, 32	
4635	16, 20, 8	
2375M	E4, E5, E6, E7, E8, E10	
4375M	E11, E12, E14, E16, E18	
1025T	T15, T20, T25, T27, T30, T40, T45, T50	
1025H	H2, H2.5, H3, H4, H5, H6, H7, H8, H10	
1025M	M4, M5, M6, M8, M10	
2221	75, 150	
4251	125, 250	
4223	55	
1062	8, 10, 11, 12, 13, 14, 15, 16, 17, 18, 19, 21, 22, 24	
1930	8x10, 11x13, 12x14, 17x19	
1421	PH1 x 80, PH2 x 100	
1422	5.5 x 125, 6.5 x 150	
277155G	477110G	
257145	457210	
2178DF		
2792	4791 2142	
361108R	611107	
	212826	

\*Garantía ilimitada, excluyendo las puntas 1/4".

Oferta válida del 01/01/2025 al 31/12/2025. Precio recomendado de venta al público en euros sin IVA. Fotos no contractuales.





**9 PZAS**  
198 x 105 x 32 mm  
Contiene 1.03  
T20, T25, T27, T30, T40, T45, T50, T55, T60

**4109PR** **1/2"** **55€<sup>B</sup>**



**9 PZAS**  
198 x 105 x 32 mm  
Contiene 1.13  
T20, T25, T27, T30, T40, T45, T50, T55, T60

**4119PR** **1/2"** **60€<sup>B</sup>**



**20 PZAS**  
445 x 135 x 50 mm  
Contiene 3.83  
4330MR 8, 9, 10, 11, 12, 13, 14, 15, 16, 17, 18, 19, 21, 22, 24, 27  
475510G 4791  
457210 425105, 425110

**4220MR** **1/2"** **124€<sup>B</sup>**



**9 PZAS**  
198 x 105 x 32 mm  
Contiene 1.03  
H3, H4, H5, H6, H7, H8, H10, H12, H14

**4110PR** **1/2"** **55€<sup>B</sup>**



**9 PZAS**  
198 x 105 x 32 mm  
Contiene 1.38  
H4, H5, H6, H7, H8, H10, H12, H14, H17

**4120PR** **1/2"** **60€<sup>B</sup>**



**New**  
**25 PZAS**  
422 x 372 x 92 mm  
Contiene 6.2  
4235M 8, 9, 10, 11, 12, 13, 14, 15, 16, 17, 18, 19, 20, 21, 22, 23, 24, 25, 26, 27, 28, 29, 30, 32, 36

**4335MR01** **1/2"** **225€<sup>B</sup>**



**4321MRE** **1/2"** **139€<sup>B</sup>**

Cofre 820003K (389 x 230 x 66 mm)  
EVA #8 (375 x 187 mm)  
Contiene 4.5  
4335M 10, 11, 12, 13, 14, 15, 16, 17, 18, 19, 21, 22, 24, 27, 30, 32  
477910B 412111G  
458312 425110 4791



**4523MRE01** **1/2"** **129€<sup>B</sup>**

Cofre 820003K (389 x 230 x 66 mm)  
EVA #8 (375 x 187 mm)  
Contiene 3.88  
4335M 8, 9, 10, 11, 12, 13, 14, 15, 16, 17, 18, 19, 21, 22, 24, 27, 30, 32  
425105, 425110 4791  
477110G 457212



**4528SR** **1/2"** **159€<sup>B</sup>**

445 x 187 x 50 mm  
Contiene 5.3  
4335S 3/8", 7/16", 15/32", 1/2", 9/16", 19/32", 5/8", 11/16", 3/4", 25/32", 13/16", 7/8", 15/16", 1", 1-1/16", 1-1/8", 1-3/16", 1-1/4"  
4635 20.8  
425105, 425110 4791  
477910G 457212



**4533SR** **1/2"** **169€<sup>B</sup>**

445 x 187 x 50 mm  
Contiene 5.7  
4335S 5/16", 3/8", 7/16", 15/32", 1/2", 9/16", 9/32", 5/8", 11/16", 3/4", 25/32", 13/16", 7/8", 15/16", 1", 1-1/16", 1-3/16", 1-1/4"  
4635 20.8  
422302  
477910B 412111G  
457310 458312



**4526MR03** **1/2"** **169€<sup>B</sup>**

**4526MR04** **1/2"** **169€<sup>B</sup>**

445 x 187 x 50 mm  
Contiene 5.7  
4335M 8, 10, 11, 13, 14, 15, 16, 17, 18, 19, 20, 21, 22, 23, 24, 27, 30, 32  
425105, 425110  
4526MR03 477910G  
4526MR04 475510G  
445215F 457212 4791





24 PZAS



**4524MRV04K** 1/2" 219€<sup>B</sup>

Cofre 820003K (389 x 230 x 66 mm), EVA #8 (375 x 187 mm).

Contiene 5.08

	4335M	8, 10, 11, 12, 13, 14, 15, 16, 17, 18, 19, 21, 22, 23, 24, 27, 28, 30, 32
	425105, 425110	
	477322GS	
	4793	
	457212	



24 PZAS

**4026MR03** 1/2" 169€<sup>B</sup>

**4026MR04** 1/2" 157€<sup>B</sup>

**4026SR03** 1/2" 169€<sup>B</sup>

445 x 187 x 50 mm

Contiene 5.95

**4026MR03 / 4026MR04**

	4330M	8, 10, 11, 13, 14, 15, 16, 17, 18, 19, 20, 21, 22, 23, 24, 27, 30, 32
	4330S	5/16", 3/8", 7/16", 15/32", 1/2", 9/16", 19/32", 5/8", 11/16", 3/4", 25/32", 13/16", 7/8", 15/16", 1", 1-1/16", 1-3/16", 1-1/4"
	425105, 425110	
	4026MR03	477910G
	4026SR03	475510G
	4026MR04	475510G
	445215F	457212
		4791



27 PZAS

CANTIDAD LIMITADA

**4527MRE01** 1/2" 199€<sup>B</sup>

**4527MRE02** 1/2" 199€<sup>B</sup>

Cofre 820011K (422 x 372 x 92 mm) EVA #9 (375 x 280 mm)

Contiene 5.95

	4335M	8, 9, 10, 11, 12, 13, 14, 15, 16, 17, 18, 19, 21, 22, 23, 24, 27, 29, 30, 32
	4527MRE01	
	4527MRE02	
	425105, 425110	
	445215F	4791
	457212	458110



32 PZAS

**4532MRE10** 1/2" 229€<sup>B</sup>

Cofre 820011K (422 x 372 x 92 mm) EVA #9 (375 x 280 mm)

Contiene 6.34

	4335M	8, 9, 10, 11, 12, 13, 14, 15, 16, 17, 18, 19, 20, 21, 22, 23, 24
	4235M	10, 13, 16, 17, 18, 19, 21, 22, 24
	425105, 425110	
	477310GS	i-beam
	445315F	i-beam
	457212	4791

**New** 27 PZAS

**4557MR** 1/2" 119€<sup>B</sup>

294 x 221 x 66 mm

Contiene 3.69

	4335M	8, 9, 10, 11, 12, 13, 14, 15, 16, 17, 18, 19, 20, 21, 22, 23, 24, 25, 26, 27, 28, 29, 30, 32, 33, 34, 36
--	-------	--





17  
PZAS

**6318MR10**  $\frac{3}{4}$ " 299€<sup>B</sup>

422 x 372 x 92 mm

Contiene

11

- 6335M 22, 24, 27, 29, 30, 32, 33, 35, 36, 38, 41, 46, 50
- 625104, 625108
- 677920F 657220



46  
PZAS

**4546MRE02**  $\frac{1}{2}$ " 289€<sup>B</sup>

Cofre 820011K (422 x 372 x 92 mm)  
EVA #9 (375 x 280 mm)

Contiene

7.14

- 4335M 8, 9, 10, 11, 12, 13, 14, 15, 16, 17, 18, 19, 20, 21, 22, 23, 24
- 4023 T20, T25, T27, T30, T40, T45, T50, T55, T60
- 4025 H4, H5, H6, H7, H8, H10, H12, H14, H17, H19
- 4026 M8, M10, M12, M14
- 425105, 425110
- 477310GS
- 445315F
- 457212 4791

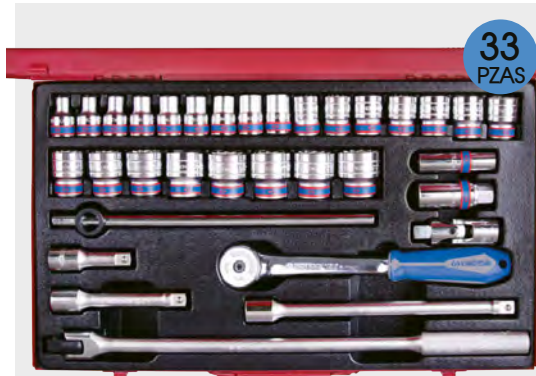

33  
PZAS

**4034MR03**  $\frac{1}{2}$ " 228€<sup>B</sup>

Contiene

4034MR03

- 4330M 8, 9, 10, 11, 12, 13, 14, 15, 16, 17, 18, 19, 20, 21, 22, 23, 24, 25, 26, 27, 28, 29, 30, 32
- 4635 16
- 4630 20.8

425103, 425105, 425110

475510G 4791 445218F 457212

476 x 282 x 57 mm

**4534MR03**  $\frac{1}{2}$ " 229€<sup>B</sup>

8.2

4534MR03

- 4335M 8, 9, 10, 11, 12, 13, 14, 15, 16, 17, 18, 19, 20, 21, 22, 23, 24, 25, 26, 27, 28, 29, 30, 32
- 4635 16, 20.8



42  
PZAS

**4042CR02**  $\frac{1}{2}$ " 234€<sup>B</sup>

476 x 282 x 57 mm

Contiene

8.5

- 4330M 10, 11, 12, 13, 14, 15, 16, 17, 18, 19, 20, 21, 22, 23, 24, 27, 30, 32
- 4330S 5/16", 3/8", 7/16", 1/2", 9/16", 19/32", 5/8", 11/16", 3/4", 25/32", 13/16", 7/8", 15/16", 1", 1-1/16", 1-1/8", 1-3/16", 1-1/4"
- 425105, 425110
- 477910G 457212 445218F 4791



16  
PZAS

**6316MR**  $\frac{3}{4}$ " 319€<sup>B</sup>

537 x 177 x 78 mm

Contiene

14.0

- 6335M 21, 22, 23, 24, 27, 30, 32, 36, 38, 41, 46, 50
- 625108, 625116
- 677920F 657220



17  
PZAS

**6317MR** 3/4" 339€<sup>B</sup>

537 x 177 x 78 mm  
Contiene 14.9

6335M 17, 19, 21, 22, 24, 27, 30, 32, 34, 36, 41, 46, 50, 55

625104, 625108, 625116 677920F



23  
PZAS

**6323MR01** 3/4" 329€<sup>B</sup>

537 x 177 x 78 mm  
Contiene 17.7

6335M 17, 19, 21, 22, 23, 24, 26, 27, 28, 29, 30, 32, 33, 34, 35, 36, 38, 41, 42

625108, 625116 672420F 657220



23  
PZAS

**6023MR** 399€<sup>B</sup> **6023SR** 419€<sup>B</sup> 3/4"

537 x 177 x 78 mm  
Contiene 17.1

<b>6023MR</b>	<b>6023SR</b>
6330M 21, 22, 23, 24, 26, 27, 28, 29, 30, 32, 34, 35, 36, 38, 41, 46, 50	6330S 7/8", 15/16", 1", 1-1/16", 1-1/8", 1-3/16", 1-1/4", 1-5/16", 1-3/8", 1-7/16", 1-1/2", 1-9/16", 1-5/8", 1-3/4", 1-13/16", 1-7/8", 2"

625104, 625108, 625116 677920F 657220 6791



24  
PZAS

**6224CR** 3/4" 399€<sup>B</sup>

537 x 177 x 78 mm  
Contiene 18.7

6330M 22, 24, 27, 30, 32, 36, 38, 41, 46, 50

6330S 1", 1-1/8", 1-1/4", 1-5/16", 1-3/8", 1-7/16", 1-1/2", 1-5/8", 1-3/4", 2"

625108, 625116 677920F 657220



25  
PZAS

**6325MR01** 3/4" 429€<sup>B</sup>

537 x 177 x 78 mm  
Contiene 18.7

6335M 19, 21, 22, 23, 24, 26, 27, 28, 29, 30, 32, 34, 35, 36, 38, 41, 46, 50, 55

625104, 625108, 625116 677820FS 657220 6791



14  
PZAS

**8015MR** 1" 649€<sup>B</sup>

660 x 205 x 108 mm  
Contiene 26.7

8330M 36, 41, 46, 50, 55, 60, 65, 70, 75, 80

825108, 825116 877932F 857225



## VASOS DE IMPACTO

CROMO  
MOLIBDENO



MÉTRICAS

Supera del **50%** como mín. normativas DIN



PULGADAS

Normativas ANSI

## ADAPTADOR DE IMPACTO



29 mm

1/2" → 3/4"

Seguridad por bola

**4866P** 1/2" → 3/4" 11,70€<sup>B</sup>

**ADAPTADOR AUMENTADOR**  
Entrada 1/2". Para el uso de vasos de impacto 3/4".



38 mm

3/4" → 1/2"

Seguridad por bola

**6874P** 3/4" → 1/2" 15,40€<sup>B</sup>

**ADAPTADOR REDUCTOR**  
Entrada 3/4". Para el uso de vasos de impacto 1/2". Par máximo : 512 Nm.



44 mm

3/4" → 1/2"

Seguridad por bola

**6864P** 3/4" → 1/2" 18€<sup>B</sup>

**ADAPTADOR REDUCTOR**  
Entrada 3/4". Para el uso de vasos de impacto 1/2". Par máximo : 512 Nm.



1"

1" → 3/4"

Seguridad por bola

**8866P** 1" → 3/4" 19€<sup>B</sup>

**ADAPTADOR REDUCTOR**  
Entrada 1". Para el uso de vasos de impacto 3/4". Par máximo : 1412 Nm.

## EXTENSIONES

Seguridad por bola

**626010P** 250 mm 3/4" 39€<sup>B</sup>

**626013P** 330 mm 3/4" 52€<sup>B</sup>



También disponible en raíl.



**10 PZAS**

**4269MS** 1/2" 90€<sup>B</sup>

Contiene 2.8



-  42690890 (90 Nm)
-  426908A0 (100 Nm)
-  426908B0 (110 Nm)
-  426908C0 (120 Nm)
-  426908D5 (135 Nm)
-  426908F0 (150 Nm)
-  426908G0 (160 Nm)
-  426908H5 (175 Nm)
-  426908J0 (190 Nm)
-  426908K0 (200 Nm)

 Necesita un control con una llave dinamo métrica.

**4269** Nm / ft.lb 1/2"

	Nm	L mm		
42690890	90	195	192	10€ <sup>B</sup>
426908A0	100	195	201	10€ <sup>B</sup>
426908B0	110	195	217	10€ <sup>B</sup>
426908C0	120	195	224	10€ <sup>B</sup>
426908D5	135	195	238	10€ <sup>B</sup>
426908F0	150	195	263	10€ <sup>B</sup>
426908G0	160	195	304	10€ <sup>B</sup>
426908H5	175	195	284	10€ <sup>B</sup>
426908J0	190	195	331	10€ <sup>B</sup>
426908K0	200	195	334	10€ <sup>B</sup>

## 6435M

	 mm	L mm		
643524M	24	90	626	21€ <sup>B</sup>
643527M	27	90	623	21€ <sup>B</sup>
643529M	29	90	670	21€ <sup>B</sup>
643530M	30	90	691	22€ <sup>B</sup>
643532M	32	90	728	22€ <sup>B</sup>
643550M	50	95	1317	42€ <sup>B</sup>
643555M	55	100	1799	42€ <sup>B</sup>
643560M	60	100	2010	39€ <sup>B</sup>
643565M	65	100	1990	42€ <sup>B</sup>

Descubre toda la serie 6435M.

19  65 mm









## 6575M

Se ajusta con los palieres del cigüeñal SCANIA.

	 mm	L mm		
657524M	E24	50	340	28€ <sup>B</sup>
657526M	E26	60	410	27€ <sup>B</sup>
657528M	E28	60	410	27€ <sup>B</sup>
657530M	E30	65	435	32€ <sup>B</sup>
657532M	E32	65	450	32€ <sup>B</sup>

**New**





**8015M**

	 mm	L mm		
801521M	H21	80	710	24,60€ <sup>B</sup>
801522M	H22	80	720	24,60€ <sup>B</sup>
801524M	H24	80	741	24,60€ <sup>B</sup>
801527M	H27	80	776	24,60€ <sup>B</sup>
801530M	H30	80	820	24,60€ <sup>B</sup>
801532M	H32	80	851	24,60€ <sup>B</sup>
801536M	H36	80	921	25,20€ <sup>B</sup>

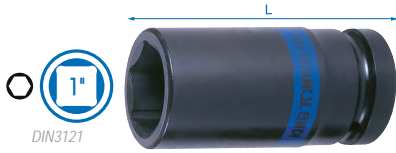

**8835M**

	Ø mm	L mm	g	€ B
883532M	32	80	714	24€ B
883533M	33	80	748	24€ B

Descubra toda la serie 8835M.

24 41 mm



**9535M**

	Ø mm	L mm	g	€ B
953546M	46	85	2233	94€ B
953550M	50	85	2300	103€ B
953555M	55	93	2660	106€ B
953560M	60	95	2840	123€ B
953565M	65	100	3150	140€ B
953570M	70	103	3460	160€ B
953575M	75	105	3700	160€ B
953580M	80	105	3900	207€ B
953585M	85	105	4175	210€ B
953590M	90	110	4600	223€ B
953595M	95	110	7570	327€ B
9535A5M	105	115	8340	418€ B
9535A0M	100	115	8104	350€ B
9535B5M	115	125	9766	584€ B
9535B7M	117	125	9954	480€ B
9535B0M	110	125	9400	480€ B
9535C5M	125	135	11148	725€ B
9535COM	120	130	13090	641€ B
9535D5M	135	140	12423	809€ B
9535DOM	130	140	12423	759€ B
9535E0M	140	150	13570	860€ B
9535F0M	150	155	14270	910€ B

**VASOS DE IMPACTO ESPECIALES PARA LLANTAS DE ALUMINIO**

**4 PZAS**

PLÁSTICO GIRATORIO ANTI-MARCA

HYUNDAI i30, HYUNDAI Tucson et KIA

MERCEDES BENZ  
Clase C type 204, 204X, Clase E type 211, 212, 207, Type SLK 172, Clase M type 164, 166, Clase S type 221, 222, Clase CL type 216

1.06

**44904MP 1/2" 58€ B**

Contiene	Ø	L mm
	494515M	15 85
	9BW4501	17 85.5
	9BW4502	21 85.5
	494522M	22 85

**3 PZAS**

PLÁSTICO GIRATORIO ANTI-MARCA

0.850

**44905MP 1/2" 28€ B**

Contiene	Ø	L mm
	494517M	17 86
	494519M	19 86
	494521M	21 86

**New**

**3 PZAS**

1.06

**4405MXL 1/2" 79€ B**

Contiene	Ø	L mm
	495517MX	17 150
	495519MX	19 150
	495521MX	21 150

**3 PZAS**

PARED EXTRA FINA

**4403MP 1/2" 42€ B**

Contiene	Ø	L mm
	4415M	17, 19, 21

0.75

**RIELES DE VASOS DE IMPACTO**



**4421MP 1/2" 61€ B**

**11 PZAS**



**7411PP 1/2" 82€ B**

**11 PZAS**



**4497MP 1/2" 119€ B**

**17 PZAS**

# COFRES DE VASOS DE IMPACTO



**PULGADAS**  
Normativas ANSI



**CROMO MOLIBDENO**



**MÉTRICAS**  
Supera **50%** como mín. del **50%** normativas DIN



**7 PZAS**

60 mm

**4417MP**  $1/2"$  **103€<sup>B</sup>**

198 x 108 x 32 mm

Contiene  940

 4053 T25, T30, T40, T45, T50, T55, T60



**7 PZAS**

100 mm

**4457MP**  $1/2"$  **127€<sup>B</sup>**

244 x 118 x 37 mm

Contiene  1.44

 4065 H4, H5, H6, H8, H10, H12, H14



**8 PZAS**

80 mm

**4410MP**  $1/2"$  **62€<sup>B</sup>**

246 x 103 x 38 mm

Contiene  2.3

 4435M 12, 13, 14, 17, 19, 21, 22, 23



**8 PZAS**

**4408MP**  $1/2"$  **41€<sup>B</sup>**

270 x 73 x 46 mm

Contiene  1.3

 4535M 10, 12, 13, 14, 17, 19, 21, 24



**8 PZAS**

60 mm

**4418MP**  $1/2"$  **104€<sup>B</sup>**

198 x 105 x 32 mm

Contiene  1.34

 4055 5, 6, 8, 10, 12, 14, 17, 19



**14 PZAS**

270 x 100 x 49 mm

**4414MP**  $1/2"$  **62€<sup>B</sup>**

**4414SP**  $1/2"$  **66€<sup>B</sup>**

Contiene  2.25

**4414MP**

 4535M 10, 11, 12, 13, 14, 15, 16, 17, 18, 19, 21, 22, 24, 27

**4414SP**

 4535S 3/8", 7/16", 1/2", 9/16", 5/8", 11/16", 3/4", 13/16", 7/8", 15/16", 1", 1-1/16", 1-1/8", 1-1/4"



**15 PZAS**

445 x 135 x 50 mm

**4415MP02**  $1/2"$  **123€<sup>B</sup>**

**4415MP03**  $1/2"$  **121€<sup>B</sup>**

Contiene  4.9

**4415MP02**

 4435M 10, 11, 12, 13, 14, 15, 16, 17, 18, 19, 21, 24, 27, 30, 32

**4415MP03**

 4435M 10, 11, 12, 13, 14, 15, 16, 17, 19, 21, 22, 24, 27, 30, 32



**22 PZAS**

**4422MP01**  $1/2"$  **149€<sup>B</sup>**

440 x 160 x 145 mm

Contiene  7.3

 4535M 8, 9, 10, 11, 12, 13, 14, 16, 17, 18, 19, 21, 22, 23, 24, 27, 30, 32

 4797  426010  4866P  414710



**27 PZAS**

**4427MP**  $1/2"$  **169€<sup>B</sup>**

Contiene  4.09

 4535M 8, 9, 10, 11, 12, 13, 14, 15, 16, 17, 18, 19, 20, 21, 22, 23, 24, 25, 26, 27, 28, 29, 30, 32, 33, 34, 36

**4827MP**  $1/2"$  **189€<sup>B</sup>**

Contiene  4.73

 4530M 8, 9, 10, 11, 12, 13, 14, 15, 16, 17, 18, 19, 20, 21, 22, 23, 24, 25, 26, 27, 28, 29, 30, 32, 33, 34, 36



**9 PZAS**

ESPIGAS INTERIORES

**7K09MP**  $1/2"+3/4"$  **419€<sup>B</sup>**





**9 PZAS**

ESPIGAS EXTERIORES

**7K09MP01**  $1/2"+3/4"$  **349€<sup>B</sup>**

**JUEGO DE VASOS DE IMPACTO 1/2" Y 3/4"**

Pared fina. Para apretar y aflojar tuercas con muescas de rodamiento de bolas DIN 981. Se puede usar con extensiones, carracas, etc.. Uso: Colocar/Quitar rodamientos, piñones, rodamientos de rodillos cónicos, rodamientos de bolas, etc. Camiones, obras públicas, silvicultura, etc.

Contiene		
7K09MP	 1/2" 44K8	TMFS 4, TMFS 5, TMFS 6, TMFS 7, TMFS 8
	 3/4" 64K8	TMFS 9, TMFS 10, TMFS 11, TMFS 12
7K09MP01	 1/2" 44K7	TMFS 4, TMFS 5, TMFS 6, TMFS 7, TMFS 8
	 3/4" 64K7	TMFS 9, TMFS 10, TMFS 11, TMFS 12

**6 PZAS**

**786P06** 40€<sup>B</sup>

**COFRE DE ADAPTADORES DE IMPACTO DE 1/4", 3/8", 1/2" Y 3/4"**

Contiene 1.31

3/8" → 1/4" 2863P

3/8" → 1/2" 4863P  
par máximo 202 Nm

1/4" → 3/8" 3862P  
par máximo 62 Nm

3/4" → 1/2" 4866P

1/2" → 3/8" 3864P

1/2" → 3/4" 6864P  
par máximo 512 Nm

**14 PZAS**

422 x 372x 92 mm

**6414MP** **3/4"** 300€<sup>B</sup>

Contiene 11.94

6435M 19, 21, 22, 24, 26, 27, 29, 30, 32, 33, 35, 36, 38, 41

90 mm

**8 PZAS**

90 mm

445 x 100 x 65 mm

**6410MP** **3/4"** 165€<sup>B</sup>

Contiene 7.1

6435M 26, 29, 30, 32, 34, 35, 36, 38

**8 PZAS**

90 mm

241 x 124 x 68 mm

**6458MP** **3/4"** 155€<sup>B</sup>

Contiene 3.9

6435M 24, 27, 29, 30, 32, 33, 36, 38

422 x 372x 92 mm

**6414MP** **3/4"** 300€<sup>B</sup>

Contiene 11.94

6435M 19, 21, 22, 24, 26, 27, 29, 30, 32, 33, 35, 36, 38, 41

**8 PZAS**

241 x 124 x 68 mm

**6408MP10** **3/4"** 104€<sup>B</sup>

**6408SP10** **3/4"** 118€<sup>B</sup>

Contiene 3.5

**6408MP10**

6515M 19, 22, 24, 27, 30

6535M 32, 36, 38

**6408SP10**

6535S 3/4", 7/8", 15/16", 1-1/16", 1-3/16", 1-1/4", 1-7/16", 1-1/2"

**8 PZAS**

445 x 100 x 65 mm

**6409MP** **3/4"** 142€<sup>B</sup>

**6409MP03** **3/4"** 139€<sup>B</sup>

**6409SP** **3/4"** 133€<sup>B</sup>

Contiene 4.6

**6409MP**

6535M 26, 29, 30, 32, 34, 35, 36, 38

**6409MP03**

6535M 21, 22, 24, 27, 30, 32, 36, 41

**6409SP**

6535S 1", 1-1/16", 1-1/8", 1-1/4", 1-5/16", 1-3/8", 1-7/16", 1-1/2"

**14 PZAS**

422 x 372x 92 mm

**6424MP** **3/4"** 349€<sup>B</sup>

Contiene 11.58

6535M 24, 27, 30, 32, 33, 34, 36, 38, 41, 46, 50, 55, 60, 65

**8 PZAS**

280 x 130 x 74 mm

**8410MP** **1"** 159€<sup>B</sup>

Contiene 6.4

8535M 24, 27, 30, 32, 33, 36, 38, 41

**8 PZAS**

80 mm

445 x 120 x 68 mm

**8408MP10** **1"** 155€<sup>B</sup>

Contiene 6.9

8835M 24, 27, 30, 32, 33, 36, 38, 41

422 x 372x 92 mm

**6424MP** **3/4"** 349€<sup>B</sup>

Contiene 11.58

6535M 24, 27, 30, 32, 33, 34, 36, 38, 41, 46, 50, 55, 60, 65

**19 PZAS**

440 x 160 x 145 mm

**6420MP01** **3/4"** 295€<sup>B</sup>

Contiene 12.8

6535M 19, 21, 22, 23, 24, 26, 27, 28, 29, 30, 32, 33, 34, 35, 36, 38, 41

6797 626010

**8 PZAS**

280 x 130 x 74 mm

**8410MP** **1"** 159€<sup>B</sup>

Contiene 6.4

8535M 24, 27, 30, 32, 33, 36, 38, 41

**8 PZAS**

80 mm

445 x 120 x 68 mm

**8408MP10** **1"** 155€<sup>B</sup>

Contiene 6.9

8835M 24, 27, 30, 32, 33, 36, 38, 41

440 x 160 x 145 mm

**6420MP01** **3/4"** 295€<sup>B</sup>

Contiene 12.8

6535M 19, 21, 22, 23, 24, 26, 27, 28, 29, 30, 32, 33, 34, 35, 36, 38, 41

6797 626010



# HERRAMIENTA NEUMÁTICA



GARANTÍA DE 2 AÑOS



108 Nm

37423080



189€<sup>B</sup>



15 PZAS

CROMO MOLIBDENO

supera del 50% como mín. normativas DIN y ANSI

1356 Nm

44803AMP01



307€<sup>B</sup>



Contiene

5.7

- 4535M 17, 18, 19, 21, 22, 24, 27
- 4435M 17, 19, 21
- 33461100 (1356 Nm) SY251M (1/4" BSPT)
- 426005P 4799P LUBE15



NEW TWIN HAMMER

881 Nm

33411050



249€<sup>B</sup>



109 mm

1 2 3 velocidades

apriete / aflojamiento

JUMBO HAMMER

678 Nm

33431050



209€<sup>B</sup>



NEW TWIN HAMMER

1288 Nm

33481095



319€<sup>B</sup>



NEW TWIN HAMMER

1085 Nm

33621075



419€<sup>B</sup>



NEW TWIN HAMMER

1491 Nm

33681100



389€<sup>B</sup>



NEW TWIN HAMMER

2440 Nm

33831180



844€<sup>B</sup>



TWIN HAMMER

CANTIDAD LIMITADA

2712 Nm

33861200



909€<sup>B</sup>



33862200

945€<sup>B</sup>



	Cuadrado conductor	Pasador	Tamaño del perno	Velocidad de rotación	Par Máximo	Largo	Entrada de aire	Manguera de aire	Presión de aire	Consumo de aire	Nivel sonoro	Nivel de vibraciones	Peso
	Inch	Estd. / Largo	mm	R.P.M	Nm	mm	Inch	Ø Int.	bar	L/min	DBA	M/S <sup>2</sup>	kg
37423080	1/2"	Estándar	M10	280	108	280	1/4"	3/8"	6.2	113	93	2.07	1.25
33411050	1/2"	Estándar	M19	8000	881	194	1/4"	3/8"	6.2	125	96.5	8.13	2.80
33461100	1/2"	Estándar	M24	9500	1356	190	1/4"	3/8"	6.3	207	99.2	13.32	2.30
33431050	1/2"	Estándar	M16	9000	678	109	1/4"	3/8"	6.2	142	101.02	8.70	1.35
33481095	1/2"	Estándar	M24	8000	1288	197	1/4"	3/8"	6.2	190	96	8.10	2.25
33621075	3/4"	Estándar	M24	6500	1085	228	1/4"	3/8"	6.2	198	97.28	6.89	4.50
33681100	3/4"	Estándar	M30	8000	1491	211	1/4"	3/8"	6.2	190	96	8.98	2.35
33831180	1"	Estándar	M38	4000	2440	371	1/2"	3/4"	6.2	255	102.11	8.84	11.50
33861200	1"	Estándar	M36	5000	2712	347	1/2"	3/4"	6.2	255	106	17.20	7.40
33862200	1"	Largo	M36	5000	2712	487	1/2"	3/4"	6.2	255	104	14.5	8.10

Oferta válida del 01/01/2025 al 31/12/2025. Precio recomendado de venta al público en euros sin IVA. Fotos no contractuales.



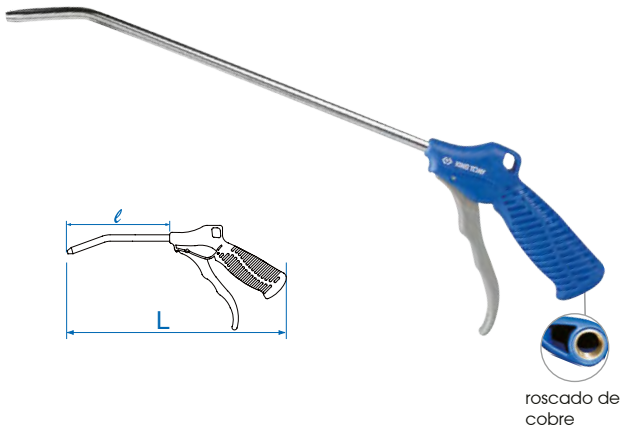

**7990**

### SOPLADORAS NEUMÁTICAS

Conducto de acero. Mango de fibra de nylon.

	Largo del conducto	Largo	Entrada de aire	Presión de aire	Consumo de aire	Nivel sonoro	Peso	
	mm	mm	Inch	bar	L/min	DBA	g	
7990004	100	245	1/4"	6.2	350	85	200	7,60€ <sup>B</sup>
7990010	250	420	1/4"	6.2	350	85	240	10€ <sup>B</sup>
7990013	330	475	1/4"	6.2	350	85	260	11€ <sup>B</sup>
7990020	500	650	1/4"	6.2	350	85	300	13€ <sup>B</sup>



**7998**

### PULVERIZADORES DE LIMPIEZA NEUMÁTICO

Adecuado para pulverizar una amplia gama de aceites, productos de limpieza y líquidos antioxidantes. Equipado con una válvula reguladora de fluido/aire.

	Capacidad	Presión de aire en trabajo	Entrada de aire	Peso		
	cc.	bar	Inch	g		
7998206	-	600	6.2 - 10.3 90 - 150	1/4"	600	25€ <sup>B</sup>
7998210	acero inoxidable	1000	6.2 - 10.3 90 - 150	1/4"	800	38€ <sup>B</sup>

**New**

**7**  
PZAS



**7990A0**

58€<sup>B</sup>

### COFRE MINI PISTOLA DE SOPLAR PROGRESIVA CON BOQUILLAS INTERCAMBIABLES

6 boquillas intercambiables con conexión rápida.  
Dimensiones del cofre: 207 x 170 x 55 mm.  
Flujo de aire orientable en 6 ángulos.  
Conexión rápida.  
Control del caudal de aire.  
Entrada de aire en latón.  
Presión de aire (bar) : 6,2 ~ 8,2  
Presión de aire (PSI) : 90-120  
Temperatura de funcionamiento (°C) : -20°C ~ 85°C

Contiene	0.5
	7990AP02
	7990AP03
	7990AP04
	7990AP05
	7990AP06
	7990AP07
	7990A0P01



# LLAVES COMBINADAS

SIN CARRACA



Garantía Ilimitada

## 1062 I-beam



**12D12MRS** 12 PZAS  
64€<sup>B</sup>  
Contiene 1.41  
1062 8, 9, 10, 11, 12, 13, 14, 16, 17, 18, 19, 22



**12D06MRS01** 6 PZAS  
34€<sup>B</sup>  
Contiene 0.82  
1062 10, 12, 13, 14, 17, 19



**12D21MRN** 21 PZAS  
174€<sup>B</sup>  
Contiene 4.1  
1062 6, 7, 8, 9, 10, 11, 12, 13, 14, 15, 16, 17, 18, 19, 20, 21, 22, 24, 27, 30, 32



**12D09MRN** 9 PZAS  
45€<sup>B</sup>  
Contiene 0.80  
1062 8, 9, 10, 11, 12, 13, 14, 17, 19

**12D15MRN01** 14 PZAS  
88€<sup>B</sup>  
Contiene 1.96  
1062 8, 10, 11, 12, 13, 14, 15, 16, 17, 18, 19, 21, 22, 24

**12D15MRN** 15 PZAS  
124€<sup>B</sup>  
Contiene 3.32  
1062 10, 11, 12, 13, 14, 15, 16, 17, 19, 21, 22, 24, 27, 30, 32

**12D26MRN** 26 PZAS  
214€<sup>B</sup>  
Contiene 5.6  
1062 6, 7, 8, 9, 10, 11, 12, 13, 14, 15, 16, 17, 18, 19, 20, 21, 22, 23, 24, 25, 26, 27, 28, 29, 30, 32



**12A3MRN** 13 PZAS  
107€<sup>B</sup>  
Contiene 2.16  
1061 8, 10, 11, 12, 13, 14, 15, 16, 17, 18, 19, 22, 24

**12B4MRN** 24 PZAS  
272€<sup>B</sup>  
Contiene 7  
1061 6, 8, 10, 11, 12, 13, 14, 15, 16, 17, 18, 19, 20, 21, 22, 23, 24, 25, 26, 27, 28, 29, 30, 32

1061 I-beam  
+10%  
13°



**1296MRN** 6 PZAS  
229€<sup>B</sup>  
Contiene 8.4  
1071 34, 36, 38, 41, 46, 50

15°  
6 PZAS

KING TONY

CON CARRACA REVERSIBLE



15 PZAS

**1275MRN** 134€<sup>B</sup>

Contiene 3.18

1067 6, 7, 8, 10, 11, 12, 13, 14, 17, 19, 22, 24, 27, 30, 32



14 PZAS

**1214SRN01** 121€<sup>B</sup>

Contiene 3.54

5060 3/8", 7/16", 1/2", 9/16", 5/8", 11/16", 3/4", 13/16", 7/8", 15/16", 1", 1-1/16", 1-1/8", 1-1/4"



11 PZAS

**1211SR** 62€<sup>B</sup>

Contiene 1.4

5060 1/4", 5/16", 3/8", 7/16", 1/2", 9/16", 11/16", 3/4", 13/16", 7/8", 15/16"

AMPLIA GAMA DE LLAVES COMBINADAS IA DESCUBRIR!

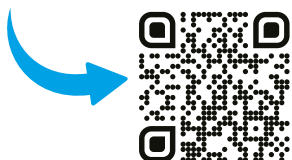

**373AM**

**Retén antideslizante**

Reversible

Gracias al retén antideslizante en el ojo, estas llaves no resbalan en las tuercas.

Se trabaja más rápido y aumenta la productividad y la seguridad.

13°

5°



**122A07MRN01** 129€<sup>B</sup>

Contiene 0.91

373AM 8, 10, 11, 12, 13, 17, 19

7 PZAS

**122A12MRN** 249€<sup>B</sup>

Contiene 2.06

373AM 8, 9, 10, 11, 12, 13, 14, 15, 17, 19, 22, 24

12 PZAS

**122A14MRN** 279€<sup>B</sup>

Contiene 2.50

373AM 8, 9, 10, 11, 12, 13, 14, 15, 16, 17, 18, 19, 22, 24

14 PZAS



10 PZAS

**12210SR** 149€<sup>B</sup>

Contiene 1.8

3732S 5/16", 3/8", 7/16", 1/2", 9/16", 5/8", 11/16", 3/4", 7/8", 15/16"

Reversible

15°

**New**

**122A12MRS03** 209€<sup>B</sup>

Contiene 1.73

373AM 8, 9, 10, 11, 12, 13, 14, 16, 17, 18, 19, 22

Fácil de reconocer Almacenamiento rápido

12 PZAS

**132A13MR** 197€<sup>B</sup>

Contiene 1.64

373AM 8, 10, 12, 13, 14, 16, 17, 18, 19

3/8" 1/2" 1/4"

13 PZAS





### CON CARRACA NO REVERSIBLE



**12112MRS02** 165€<sup>B</sup>

Carraca no reversible. 1.6

Contiene 8, 10, 11, 12, 13, 14, 15, 16, 17, 18, 19, 22



**12107MRN01** 92€<sup>B</sup>

Carraca no reversible. 910

Contiene 8, 10, 11, 12, 13, 17, 19



**12112MRN** 12 PZAS 181€<sup>B</sup>

Carraca no reversible. 1.95

Contiene 8, 9, 10, 11, 12, 13, 14, 15, 17, 19, 22, 24

**12114MRN** 14 PZAS 221€<sup>B</sup>

Carraca no reversible. 2.50

Contiene 8, 9, 10, 11, 12, 13, 14, 15, 16, 17, 18, 19, 22, 24

### CON CARRACA NO REVERSIBLE Y CABEZA ARTICULADA



**12007MRN** 125€<sup>B</sup>

Cabeza articulada. Carraca no reversible. 930

Contiene 8, 10, 12, 13, 14, 17, 19



**13013MRE** 204€<sup>B</sup>

Cabeza articulada. Carraca no reversible. 2.12

Contiene 8, 10, 12, 13, 14, 16, 17, 18, 19

1/4" 3/8" 1/2" 1/4"

**New**

12 PZAS

Fácil de reconocer Almacenamiento rápido

**13012MRS01** 217€<sup>B</sup>

Contiene 8, 9, 10, 11, 12, 13, 14, 16, 17, 18, 19, 22

1.73

### CON CARRACA EN HORQUILLA

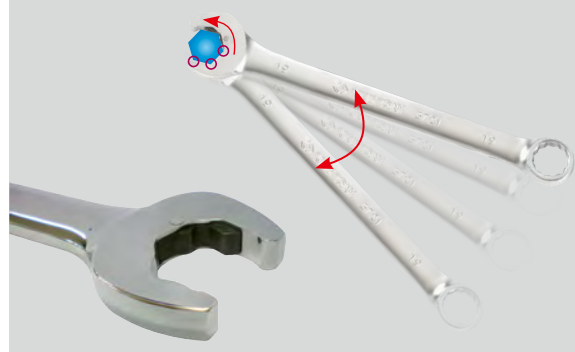

**OPEN-SIDE SPEED**

8 PZAS

**14108SR** 102€<sup>B</sup>

Contiene 5/16", 3/8", 7/16", 1/2", 9/16", 5/8", 11/16", 3/4"

1.5

## LLAVES FIJAS



### 10FO

#### LLAVES FIJAS ESTÁNDARES

La horquilla de la llave más gruesa permite aplicaciones de apriete muy alto. Acero de cromo-vanadio (Cr-V). Acabado: fosfato. DIN 894.

	Dimensiones		L		
	mm	mm	mm		
10FO17P	17	178	107	4,30€	B
10FO19P	19	178	107	5,20€	B
10FO21P	21	203	161	6€	B
10FO22P	22	203	161	6€	B
10FO23P	23	220	203	8,20€	B
10FO24P	24	220	203	8,20€	B
10FO26P	26	240	290	10€	B
10FO27P	27	240	290	10€	B
10FO29P	29	267	341	11,50€	B
10FO30P	30	272	335	11,50€	B
10FO32P	32	285	410	13€	B
10FO36P	36	317	556	18€	B
10FO38P	38	320	740	20€	B
10FO41P	41	340	875	23€	B
10FO46P	46	395	1060	30€	B
10FO50P	50	425	1402	37€	B
10FO55P	55	425	1403	42€	B
10FO60P	60	470	2544	55€	B
10FO65P	65	470	2441	63€	B
10FO70P	70	500	3457	79€	B
10FO75P	75	500	3333	87€	B



TODAS NUESTRAS  
ILLAVES CON HORQUILLAS!



### 1108MR

38€ B

Contiene 0,91

1900 6 x 7, 8 x 9, 10 x 11, 12 x 13, 14 x 15, 16 x 17, 18 x 19, 20 x 22

8 PZAS



### 1112MRN

92€ B

Contiene 2,35

1900 6 x 7, 8 x 9, 10 x 11, 12 x 13, 14 x 15, 16 x 17, 18 x 19, 20 x 22, 21 x 23, 24 x 27, 25 x 28, 30 x 32

12 PZAS

## LLAVES PARA RACORES

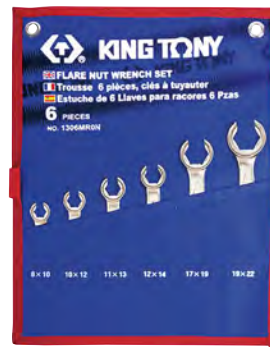

6 PZAS



### 1306MRN

6€ B

#### ESTUCHE DE LLAVES PARA RACORES

Contiene 0,90

1930 8 x 10, 10 x 12, 11 x 13, 12 x 14, 17 x 19, 19 x 22

## LLAVES CON VASO ARTICULADO



6 PZAS



### 1A06MR

82€ B

#### ESTUCHE DE LLAVES COMBINADAS CON VASO ARTICULADO

Contiene 1,32

1910 8 x 9, 10 x 11, 12 x 13, 14 x 15, 16 x 17, 18 x 19

## LLAVES DE PIPA ABIERTAS



### 1826MR

377€ B

Contiene 15

1080 6, 7, 8, 9, 10, 11, 12, 13, 14, 15, 16, 17, 18, 19, 20, 21, 22, 23, 24, 25, 26, 27, 28, 29, 30, 32

26 PZAS



### 1916MR

145€ B

Contiene 5,10

1081 8, 9, 10, 11, 12, 13, 14, 15, 16, 17, 18, 19, 21, 22, 23, 24

16 PZAS



12 PZAS

4,75

### 1812MR

116€ B

Contiene

1080 8, 10, 11, 12, 13, 14, 16, 17, 18, 19, 22, 24

### 1912MR1

119€ B

Contiene

1081 8, 10, 11, 12, 13, 14, 16, 17, 18, 19, 22, 24

GARANTÍA ILIMITADA\*

# LLAVES DE ESTRELLA

## SIN CARRACA



**1950**

	mm	L mm	g	g	€
19500810	8x10	137	40	10,10	€ <sup>B</sup>
19501012	10x12	141	55	10,80	€ <sup>B</sup>
19501113	11x13	166	93	13,30	€ <sup>B</sup>
19501214	12x14	166	94	13,30	€ <sup>B</sup>
19501315	13x15	190	126	15,20	€ <sup>B</sup>
19501417	14x17	190	126	16,80	€ <sup>B</sup>
19501618	16x18	220	156	19,60	€ <sup>B</sup>
19501719	17x19	220	174	19,70	€ <sup>B</sup>
19501922	19x22	256	255	20,90	€ <sup>B</sup>



**1406PR**

Contiene 6 PZAS  
E6xE8 - E7XE11 - E10XE12 - E14XE18 - E16XE22 - E20XE24



**1708MR**

Contiene 8 PZAS  
6 x 7, 8 x 9, 10 x 11, 12 x 13, 14 x 15, 16 x 17, 18 x 19, 21 x 23



**1712MRN**

Contiene 12 PZAS  
6 x 7, 8 x 9, 10 x 11, 12 x 13, 14 x 15, 16 x 17, 18 x 19, 20 x 22, 21 x 23, 24 x 26, 25 x 28, 30 x 32

CROMO VANADIO

supera del 30% como mín. normativas DIN y ANSI

EXTENDER PELIGRO

EXCELENTE LAS DIMENSIONES PELIGRO



**10C0**

Compatible con los mangos de la serie 11

	mm	L mm	Compatible con	g	€
10C065	65	356	113086	3200	97€ <sup>B</sup>

Descubra toda la serie 10C0

24 65 mm



**1C08MR**

Contiene 8 PZAS  
6x7, 8x9, 10x11, 12x13, 14x15, 16x17, 18x19, 20x22

**1C12MR**

Contiene 12 PZAS  
6x7, 8x9, 10x11, 12x13, 14x15, 16x17, 18x19, 20x22, 21x23, 24x26, 25x28, 30x32



**1F06MRN**

Contiene 6 PZAS  
19B0 10 x 11, 12 x 14, 13 x 15, 16 x 18, 17 x 19, 22 x 24

## CON CARRACA



Reversible  
Descubra toda la serie 3737M.  
6 24 mm

**3737M**

	mm	L mm	g	€
37370607M	6x7	115	36	24€ <sup>B</sup>
37370809M	8x9	128	45	25€ <sup>B</sup>
37371415M	14x15	190	130	28€ <sup>B</sup>
37372123M	21x23	260	408	49€ <sup>B</sup>



2 dimensiones en 1  
Reversible  
5°

**14902MR01**

Contiene 2 PZAS  
8 x 10 x 12 x 13, 3739M 16 x 17 x 18 x 19

**14903MR**

Contiene 3 PZAS  
3739M 8 x 9 x 10 x 11, 12 x 13 x 14 x 15, 16 x 17 x 18 x 19



No reversibles

**1014CQ**

Contiene 16 PZAS  
3736M 10x13  
1025Z 1, 2, 3  
1025H 3, 4, 5, 6  
1025U T10, T15, T20, T25, T30, T40

\*Garantía ilimitada, excluyendo las puntas 1/4".

Oferta válida del 01/01/2025 al 31/12/2025. Precio recomendado de venta al público en euros sin IVA. Fotos no contractuales.

# LLAVES AJUSTABLE





Rápido représ de la boca



Graduación millimétrica de la boca



Mango confortable

363110R

49€<sup>B</sup>

LLAVE AJUSTABLE EN MÉTRICO

470

361408R

2 EN 1

41€<sup>B</sup>

LLAVE AJUSTABLE CON MANDÍBULA REVERSIBLE

Gran capacidad de profundidad, con sus mandíbulas un 30% más largas que las llaves ajustables tradicionales. Apertura de la mandíbula muy grande, 50% más ancha que las llaves ajustables tradicionales. Empuñadura de TPR, perforada en el extremo.



Mandíbula reversible



Función de llave ajustable



Función de llave para tubos



38 mm



298.6

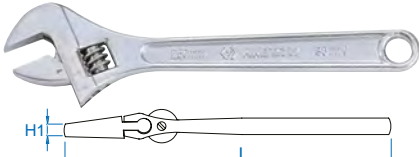

36\_1\_R

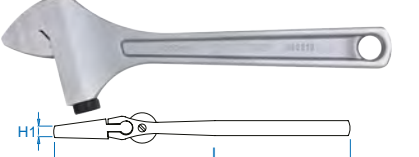

3622R

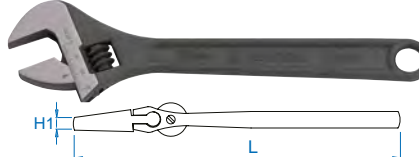

3611P

LLAVES AJUSTABLES

Graduación millimétrica de la boca. Acabado cromado.

	H1	L			
mm	mm	mm	mm	g	
361106R	20	7	150	125	12€ <sup>B</sup>
361108R	25	8	200	226	15,50€ <sup>B</sup>
361110R	30	11	250	430	20€ <sup>B</sup>
361112R	35	13	300	680	25€ <sup>B</sup>
362124HR	60	18.50	610	3140	105€ <sup>B</sup>
362115HR	43	13	375	1485	37€ <sup>B</sup>
362118HR	52	18	460	1750	63€ <sup>B</sup>

New

✓ Disponible en marzo

LLAVES AJUSTABLES LATERALES

Sin riesgo de apertura de las mordazas durante su utilización. Cromo vanadio.

	H1	L			
mm	mm	mm	mm	g	
362210R	32.8	8.3	258.5	483	37€ <sup>B</sup>
362212R	38.1	9.6	308.5	786	47€ <sup>B</sup>
362216R	50	12.8	406.5	1677	64€ <sup>B</sup>
362220R	62	14.2	505.5	2634	114€ <sup>B</sup>

LLAVES AJUSTABLES

Graduación millimétrica de la boca. Acabado fosfatado.

	H1	L			
mm	mm	mm	mm	g	
361106P	20	7	150	125	11€ <sup>B</sup>
361108P	25	8	200	226	14,50€ <sup>B</sup>
361110P	30	11	250	430	19€ <sup>B</sup>
361112P	35	13	300	680	24€ <sup>B</sup>
361115HP	43	13	375	1485	53€ <sup>B</sup>
361118HP	53	18	450	1750	82€ <sup>B</sup>
361124HP	65	23	600	3343	159€ <sup>B</sup>

## LLAVES CON HORQUILLA



LLAVES DE GOLPE CON OJO BI-HEXAGONAL

Acero de cromo-vanadio (Cr-V). Acabado: fosfato. DIN 7444.

	L	D	H			
mm	mm	mm	mm	g		
10B085	85	345	130	36	3710	158€ <sup>B</sup>
10B090	90	380	152	40	5850	187€ <sup>B</sup>
10B095	95	380	152	40	5350	193€ <sup>B</sup>
10B0A0	100	410	155	43	6445	232€ <sup>B</sup>
10B0A5	105	415	172	45	6500	279€ <sup>B</sup>
10B0B0	110	440	172	47	8000	319€ <sup>B</sup>
10B0B5	115	440	172	47	7500	328€ <sup>B</sup>
10B0C0	120	480	194	53	9000	379€ <sup>B</sup>



LLAVES DE GOLPE CON HORQUILLA

Acero de cromo-vanadio (Cr-V). Acabado: fosfato. DIN 133.

Dimensiones	L	D	H			
mm	mm	mm	mm	g		
10A080	80	395	175	33	6820	202€ <sup>B</sup>
10A085	85	395	175	33	6300	206€ <sup>B</sup>
10A090	90	440	197	38	9270	258€ <sup>B</sup>
10A095	95	440	197	38	8700	280€ <sup>B</sup>
10A0A0	100	480	230	45	10500	334€ <sup>B</sup>
10A0A5	105	480	230	45	10300	343€ <sup>B</sup>
10A0B0	110	505	238	47	14420	379€ <sup>B</sup>
10A0B5	115	505	250	53	14420	449€ <sup>B</sup>
10A0C0	120	530	258	53	15450	478€ <sup>B</sup>
10A0C5	125	530	258	56	15015	492€ <sup>B</sup>

# LLAVES DE AUTO APRIETE

CROMO VANADIO

supera del **30%** como mín. normativas DIN y ANSI

EXTENDER PELIGRO

RESPECTAR LAS DIMENSIONES PELIGRO

GARANTÍA ILIMITADA



466

361610

41€<sup>B</sup>

## LLAVE AUTO APRIETE DE REPRÍS RÁPIDO

Boca con auto bloqueo. Idónea para tornillos hexagonales, XZN®, cuadrados, TORX®; incluso dañados. Dimensiones: 8-32 mm. Largo: 265 mm.



3616S

## LLAVES AUTO APRIETE DE REPRÍS RÁPIDO

Versátil, se adapta a todas las formas de pernos y tuberías. Dientes antideslizantes eficaces en tornillos usados. Sólida y duradera: fabricado en cromo-molibdeno (CrMo).



L mm



	mm	L mm		
3616S08P	12 ~ 28	213	350	50€ <sup>B</sup>
3616S14P	20 ~ 48	347	850	71€ <sup>B</sup>

# LLAVES GANCHO



## LLAVES GANCHO

Llave gancho articulada para tuercas de muescas laterales. 1 llave reemplaza varias medidas de llaves fijas. Cubre varios tamaños de tuerca.

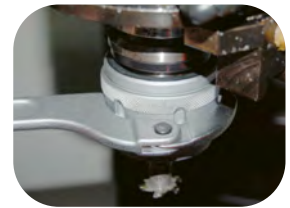

mm

L mm



	mm	L mm		
364135	13~35	174	96	22€ <sup>B</sup>
364150	35~60	212	166	27€ <sup>B</sup>
364180	50~80	285	352	37€ <sup>B</sup>
3641C0	80~120	348	652	51€ <sup>B</sup>
364110	120~180	480	1260	69€ <sup>B</sup>

# LLAVES EN CRUZ



4506MR01

1/2"

47€<sup>B</sup>

## LLAVE EN T DESMONTABLE 1/2" CON VASOS

Empuñadura ergonómica desmontable con cuadrado 1/2". Más rapidez gracias a su sistema de rotación. Permite alcanzar sitios con difícil acceso.

Contiene

1.56



17, 19, 21, 23

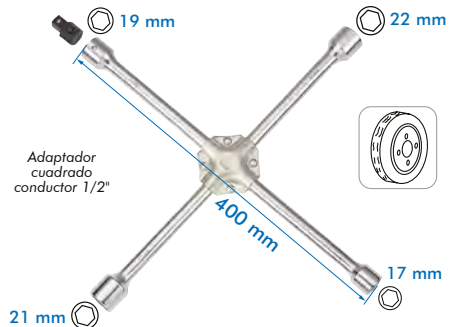

Adaptador cuadrado conductor 1/2"

21 mm

1.7

19911722

32€<sup>B</sup>

## LLAVE EN CRUZ 1/2"

Llave para el desmontaje de las ruedas. Acabado cromado.

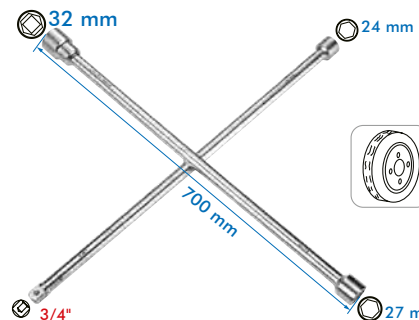

19932427

78€<sup>B</sup>

## LLAVE EN CRUZ 3/4"

Llave para el desmontaje de las ruedas. Acabado cromado.



# ALICATES



Dentadura gruesa.

**65117C**

44€<sup>B</sup>

## ALICATE MULTITOMA ESTÁNDAR

DIN ISO 8976.

1.15

L mm	A mm	B mm	mm	número de posiciones
425	58	55	100	7



4 PZAS

**42124GP04**

90€<sup>B</sup>

Contiene

1.5

	623208		611108
	631108		651710C



Dentadura gruesa.

**6517C**

## ALICATES MULTITOMA CON BRAZOS ENCAJADOS CON CIERRE

DIN ISO 8976. Engranaje con bloqueo automático sobre los tubos. Toma perfecta de las tuercas.

L mm	A mm	B mm	mm	número de posiciones	g	€ <sup>B</sup>	
651708C	200	54	44	40	16	190	29€
651710C	250	68	56	60	22	360	32€
651712C	310	89	73	70	26	540	38€



Filos con bisel



Dentadura gruesa.

**611108**

20€<sup>B</sup>

## ALICATE UNIVERSAL ESTÁNDAR

Empuñadura de PP + TPR. DIN ISO 5749.

L mm	Capacidad de corte (Ø mm)	g
213	<ul style="list-style-type: none"> <li>4.0 Alambre blando</li> <li>3.0 Alambre semiduro</li> <li>2.0 Alambre duro</li> <li>1.6 Alambre</li> </ul>	340



Mordazas lisas

**651810C**

48€<sup>B</sup>

## TENAZA LLAVE

Mordazas lisas. Ideales para evitar daños en piezas de trabajo frágiles. Ideal para agarrar, sujetar, presionar y doblar piezas de trabajo. Alta potencia de agarre con transmisión de fuerza manual 8 veces superior.

509



La función de carraca permite apretar y soltar los pernos de forma rápida y sencilla.



L mm	A mm	B mm	mm	número de posiciones
266	35.5	57	42	17



Filos con bisel



Tipo "gran esfuerzo"

**611209**

28,80€<sup>B</sup>

## ALICATE UNIVERSAL

Aprieta tubo integrado. Empuñadura de PP + TPR. DIN ISO 5746.

L mm	Capacidad de corte (Ø mm)	g
225	<ul style="list-style-type: none"> <li>4.0 Alambre blando</li> <li>3.0 Alambre semiduro</li> <li>2.2 Alambre duro</li> <li>2.0 Alambre</li> </ul>	389



Filos con bisel



**621106** 16€<sup>B</sup>

**ALICATE CORTANTE ESTÁNDAR**

Empuñadura de PP + TPR. DIN ISO 5749.

L mm	Capacidad de corte (Ø mm)	kg
163	4.0 Alambre blando	180
	2.8 Alambre semiduro	
	2.0 Alambre duro	
	1.6 Alambre	



Filos con bisel



Tipo "gran esfuerzo"

**623208** 19€<sup>B</sup>

**ALICATE CORTANTE ESTÁNDAR - MODELO «GRAN ESFUERZO»**

Empuñadura de PP + TPR. DIN ISO 5749.

L mm	Capacidad de corte (Ø mm)	kg
200	5.0 Alambre blando	280
	3.5 Alambre semiduro	
	2.2 Alambre duro	
	2.0 Alambre	



Filos con bisel



Mordazas lisas

**631108** 18,20€<sup>B</sup>

**ALICATE CON BOCA SEMI REDONDA**

Empuñadura de PP + TPR. DIN ISO 5749.

L mm	Capacidad de corte (Ø mm)	kg
200	4.0 Alambre blando	227
	3.0 Alambre semiduro	
	2.0 Alambre duro	
	1.6 Alambre	



Filos con bisel

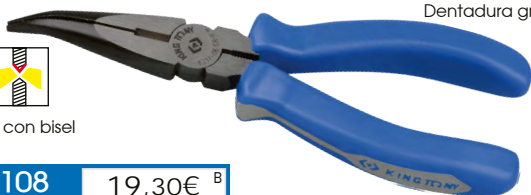

Dentadura gruesa.

**633108** 19,30€<sup>B</sup>

**ALICATE CON BOCA SEMI REDONDA ACODADA**

Empuñadura de PP + TPR. DIN ISO 5745.

L mm	Capacidad de corte (Ø mm)	kg
200	4.0 Alambre blando	218
	3.0 Alambre semiduro	
	2.0 Alambre duro	
	1.6 Alambre	

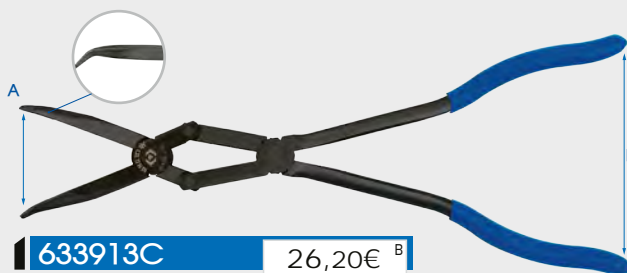

**633913C** 26,20€<sup>B</sup>

**ALICATES CON MORDAZAS SEMICIRCULARES DOBLADAS, EXTRALARGAS Y DE DOBLE ARTICULACIÓN**

A mm	B mm	L mm	kg
50	110	335	369

Mordazas lisas



280 mm

**631911C** 19€<sup>B</sup>

**ALICATE CON BOCA SEMI REDONDA EXTRA LARGA**

Diseño de bocas finas ideal para los accesos difíciles.

Mordazas lisas



Modelo reversible



**6122X**

**ALICATE DE FRENAR AUTOMÁTICO REVERSIBLE**

El simple hecho de tirar retuerce el cable uniformemente. Ideal para torcer los cables de frenos, para garantizar el bloqueo de los ensamblajes que sufren vibraciones u otra fuerza.

	L mm	Ø alambre máximo para torcer mm	kg	
<b>612206X</b>	152	Ø 1.0	0.33	72€ <sup>B</sup>
<b>612209X</b>	229	Ø 1.5	0.45	76€ <sup>B</sup>



Filos con bisel

**641106** 17€<sup>B</sup>

### ALICATE CORTANTE FRONTAL

Empuñadura de PP + TPR. DIN ISO 5748.

L mm	Capacidad de corte (Ø mm)	kg
163	4.0 Alambre blando	240
	3.0 Alambre semiduro	
	1.6 Alambre duro	
	1.6 Alambre	



Filos con bisel

**6431**

### TENAZA «RUSA»

Acero forjado. Empuñadura de PVC. DIN ISO 5748.

L mm	Capacidad de corte Ø mm			kg	€ <sup>B</sup>	
	Alambre blando	Alambre Semiduro	Alambre duro			
643110	254	3.0	2.0	1.6	445	16€ <sup>B</sup>
643111	278	3.0	2.2	1.8	510	17€ <sup>B</sup>

## REMACHADORAS



para



**79711**

58€<sup>B</sup>

### REMACHADORA MANUAL "A 2 MANOS"

Para remache de Ø 3.2, 4, 4.8, 6.4 mm. Cuerpo de aluminio forjado. Largo: 460 mm.

kg 1.49



Tipo "gran esfuerzo"



Corte central.

**613308** 49€<sup>B</sup>

### ALICATE CORTANTE DE GRAN DESMULTIPLICACIÓN

Endurecido por inducción. Empuñadura de PP + TPR. DIN ISO 5749.

L mm	Capacidad de corte (Ø mm)	kg
200	6.0 Alambre blando	399
	5.0 Alambre semiduro	
	4.0 Alambre duro	
	3.5 Alambre	



Corte central.

**6131**

### CORTA PERNOS

Certificado GS y TÜV.



L mm	Capacidad de corte Ø mm		kg	€ <sup>B</sup>	
	HRC 15	HRC 35			
613112	300	5	4	0.76	33€ <sup>B</sup>
613114	350	7	5	1	39€ <sup>B</sup>
613118	450	8	6	1.51	48€ <sup>B</sup>
613124	600	10	8	2.35	59€ <sup>B</sup>
613130	750	13	10	3.75	81€ <sup>B</sup>
613136	900	16	11	5.50	109€ <sup>B</sup>
613142	1050	18	13	8.56	144€ <sup>B</sup>



para



6 PZAS

**79731**

93€<sup>B</sup>

### REMACHADORA DOS MANOS

4 conductos de acero inoxidable. Para remaches de acero inoxidable o de aluminio: M5, M6, M8 y M10. Cuerpo de aluminio forjado. Largo: 472 mm.

kg 1.86



para



**212010**

25€<sup>B</sup>

### REMACHADORA MANUAL

Para remache de Ø 2.4, 3.2, 4, 4.8 mm. Cuerpo de acero forjado. 4 embocaduras. Largo: 260 mm.

kg 539



para



85 PZAS

**213009MR**

73€<sup>B</sup>

### COFRE CON REMACHADORA MANUAL Y REMACHES

Pensado para colocar objetos en metal fino. 4 puntas intercambiables (M4, M5, M6, M8). 80 remaches de hierro. Largo: 265 mm. Dimensiones del termoformado: 186 x 375 mm.





kg 1.32

# ALICATES CIRCLIPS



4 PZAS







**42114GP**  **67€** <sup>B</sup>

Contiene		 0.62	
	68HS07	L 180 mm, Ø 18-60 mm	
	68HB07	L 170 mm, Ø 18-60 mm	
	68SS07	L 180 mm, Ø 18-60 mm	
	68SB07	L 170 mm, Ø 18-60 mm	



6 PZAS



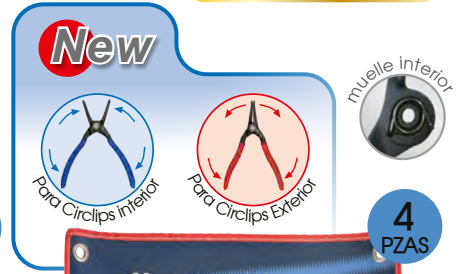

**42116GP**  **105€** <sup>B</sup>

Contiene		 1.33	
	68HS07	L 180 mm, Ø 18-60 mm ;	
	68HS10	L 250 mm, Ø 30-100 mm	
	68HB07	L 170 mm, Ø 18-60 mm	
	68SS07	L 180 mm, Ø 18-60 mm ;	
	68SS10	L 250 mm, Ø 30-100 mm	
	68SB07	L 170 mm, Ø 18-60 mm	



4 PZAS

**42154GP**  **60€** <sup>B</sup>







Contiene		 0.62	
	66HS07	L 188 mm, Ø 19-60 mm	
	66HB07	L 175 mm, Ø 19-60 mm	
	66SS07	L 188 mm, Ø 19-60 mm	
	66SB07	L 175 mm, Ø 19-60 mm	



11 PZAS

**45211PP**  **199€** <sup>B</sup>

Bocas intercambiables. Empuñaduras con bloqueo con carraca.









Contiene		 3.32	
		L 406 mm, Ø 82-175 mm	
	45°	Ø 82-175 mm	
	90°	Ø 82-175 mm	
		L 406 mm, Ø 82-165 mm	
	45°	Ø 82-165 mm	
	90°	Ø 82-165 mm	



15 PZAS

**45115PP**  **89€** <sup>B</sup>

Bocas intercambiables. Empuñaduras con bloqueo con carraca.

Contiene		 1.3	
		L 267 mm, Ø 65-140 mm	
	15°	Ø 65-140 mm	
	45°	Ø 65-140 mm	
	90°	Ø 65-140 mm	
		L 267 mm, Ø 65-120 mm	
	15°	Ø 65-120 mm	
	45°	Ø 65-120 mm	
	90°	Ø 65-120 mm	

# MORZADAS DE PRESIÓN

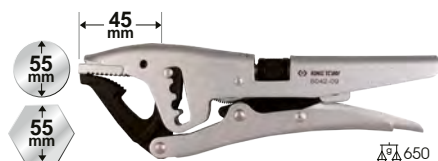

**604209** 58€<sup>B</sup>

## MORDAZA DE PRESIÓN CON CREMALLERA

Apriete max.: 620 daN.  
Largo: 220 mm.  
Anchura de mordazas: 16 mm.  
Apriete y desbloqueo fáciles, de una sola y única mano. Cremallera 4 posiciones. Protección del cuerpo por cromado. Ajuste de la fuerza de apriete con la moleta.

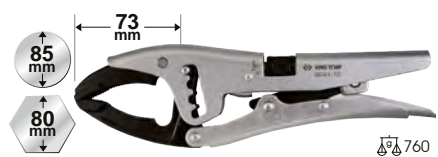

**604310** 51€<sup>B</sup>

## MORDAZA DE PRESIÓN CON CREMALLERA

Apriete max.: 310 daN.  
Largo: 250 mm.  
Anchura de mordazas: 16 mm.  
Apriete y desbloqueo fáciles, de una sola y única mano. Cremallera 4 posiciones. Protección del cuerpo por cromado. Ajuste de la fuerza de apriete con la moleta.



**604410** 65€<sup>B</sup>

## MORDAZA DE PRESIÓN CON CREMALLERA

Apriete max.: 320 daN.  
Largo: 250 mm.  
Anchura de mordazas: 16 mm.  
Apriete y desbloqueo fáciles, de una sola y única mano. Cremallera 4 posiciones. Protección del cuerpo por cromado. Ajuste de la fuerza de apriete con la moleta.

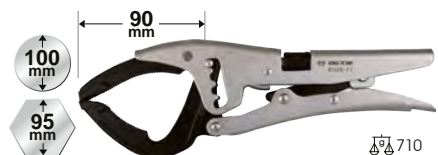

**604511** 74€<sup>B</sup>

## MORDAZA DE PRESIÓN CON CREMALLERA

Apriete max.: 290 daN.  
Largo: 270 mm.  
Anchura de mordazas: 16 mm.  
Apriete y desbloqueo fáciles, de una sola y única mano. Cremallera 4 posiciones. Protección del cuerpo por cromado. Ajuste de la fuerza de apriete con la moleta.

## 6011

### MORZADAS DE PRESIÓN MONO PUNTO

Empuñadura de acero al cromo-molibdeno (CR-MO).



	L mm	mm	mm		
<b>601107R</b>	185	38	367	16€ <sup>B</sup>	Acabado cromado pulido.
<b>601110</b>	254	48	542	19€ <sup>B</sup>	Acabado niquelado.

New



**631509** 19,80€<sup>B</sup>

## MORZADAS DE PRESIÓN MONO PUNTO BOCA LARGA

Bocas finas y largas. Reglaje por tornillo trasero. Corta hilo integrado. Perfecto para las piezas con acceso difícil.

L mm	mm	mm
221	70	393



**665509** 31€<sup>B</sup>

## MORDAZA DE PRESIÓN CON CADENA

Reglaja por tornillo trasero. Mantiene fácilmente y rápidamente las formas irregulares.

L mm	mm	mm
225	Ø60 - 140	733



**40114GP** 84€<sup>B</sup>

## JUEGO DE MORZADAS DE PRESIÓN

Contiene					
	601107R	Apertura máxima 48		603110	Apertura máxima 45
	631506	Apertura máxima 51		661511	Apertura máxima 100

4 PZAS

2,4

# DESTORNILLADORES

## DESTORNILLADORES



Agujero para colgar



Varilla redonda



7 PZAS

SNCM +V

**30317PR** 32€<sup>B</sup>

Contiene  $\Delta$  780

- 1423 T10x75, T15x75, T20x100, T25x100, T27x100, T30x125, T40x150



9 PZAS

SNCM +V

**30319PR** 39€<sup>B</sup>

Contiene  $\Delta$  880

- 1423 T8x75, T9x75, T10x75, T15x75, T20x100, T25x100, T27x100, T30x125, T40x150



7 PZAS

SNCM +V

**30117MR** 31€<sup>B</sup>

Contiene  $\Delta$  720

- 1421 PH1x80, PH2x100
- 1422 3x75, 4x100, 5.5x125, 6.5x150, 8x175



6 PZAS

SNCM +V

**31116MR** 25€<sup>B</sup>

Contiene  $\Delta$  560

- 1421 PH0x60, PH1x80, PH2x100
- 1422 3x75, 5.5x100, 6.5x150

### Mango ergonómico

- ★ En PP + TPR
- ★ Antideslizante
- ★ Resistente frente a las agresiones químicas y petrolíferas

## DESTORNILLADORES CON VARILLA PASANTE



Varilla pasante



Cazoleta en el borde que permite golpes ligeros



Varilla hexagonal



6 PZAS

SNCM +V

**30206MR** 47€<sup>B</sup>

Contiene  $\Delta$  1.2

- 1461 PH1x75, PH2x100, PH3x150
- 1462 5.5x100, 6.5x150, 8x175

## DESTORNILLADORES CON CUCHILLAS RECTAS



Varilla rectilínea

6 PZAS

S2

**30106AMRB** 19,70€<sup>B</sup>

Contiene  $\Delta$  560

- 14A1 PH1 x 80, PH2 x 100
- 14A2 3 x 75, 4 x 100, 5.5 x 152, 6.5 x 150



3 PZAS

**31003MR** 21€<sup>B</sup>

Contiene  $\Delta$  384

- 1421 Extra largo PH2 x 300
- 1422 Extra largo 6.5 x 300



212118



12 PZAS

**30112MR** 94€<sup>B</sup>

Contiene  $\Delta$  1.3

- 1450 4, 4.5, 5, 5.5, 6, 7, 8, 9, 10, 11, 12, 13

**PIÉNSELO!**



88

**79B101**

6,40€<sup>B</sup>

**MAGNETIZADOR /  
DESMAGNETIZADOR**

Puede magnetizar / desmagnetizar rápidamente las puntas de los destornilladores o las puntas de atornillar

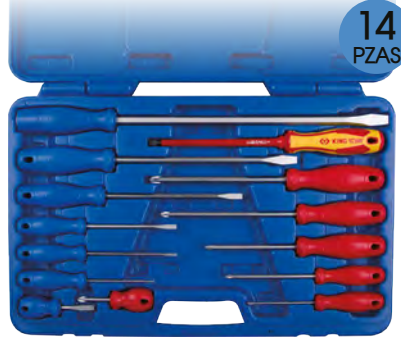

14  
PZAS

**35114MR**

63€<sup>B</sup>

Contiene

2.4

⊕ 1411	PH0 x 75 , PH1 x 100 , PH2 x 100 , PH2 x 150 , PH2 x 38 , PH3 x 150
⊖ 1412	3 x 75, 4 x 100, 5,5 x 125, 6,5 x 150, 6,5 x 38, 8 x 200
⊖ 1472	6,5 x 150
⊖ 1482	10 x 300



11  
PZAS

**32518MR**

42€<sup>B</sup>

**COFRE DE DESTORNILLADOR  
CON VARILLAS REVERSIBLES**

Largo de las varillas : 125 mm.

Contiene

700

⊕ 1317PN	PH1 x PH2
⊖ 1317SN	4 x 6 , 5 x 7
⊕ 1317ZN	PZ1 x PZ2
⊕ 1317TN	T10 x T15 , T20 x T25 , T30 x T40
⊖ 1317BHN	H4 x H4 , H5 x H5 , H6 x H6
	91232



**New**



25

**76MBH**

6,30€<sup>B</sup>

**MAGNETIZADOR /  
DESMAGNETIZADOR COMPACTO**

3 en 1: magnetizador, desmagnetizador y soporte de almacenamiento. La magnetización facilita el almacenamiento en superficies metálicas. Adaptado para varios herramientas, como destornilladores, llaves hexagonales, puntas, etc.



Desmagnetización rápida de la herramienta al deslizarla sobre el desmagnetizador.



Imantación rápida al insertar la herramienta.



El frente está diseñado para retener los tornillos y evitar que caigan.



Los tornillos de repuesto pueden ser imantados para evitar pérdidas.

**No desgaste más sus destornilladores... ¡Piense en usar palanca!**



4  
PZAS

**9TK014**

58€<sup>B</sup>

**JUEGO DE PALANCAS DE FUERZA**

Contiene

1.85

Reduce el efecto muelle durante el esfuerzo. Acero reforzado y templado. Empuñadura de 2 materiales PP+TPR. Cromo Vanadio. Termoformado 650x150x45 mm.

	9TK108
	9TK112
	9TK118
	9TK124



4  
PZAS

**9TK034**

59€<sup>B</sup>

**JUEGO DE PALANCAS DE FUERZA**

Contiene

1.73

El extremo curvado asegura un mejor efecto de palanca en áreas pequeñas. La punta afilada es ideal para trabajos de alineación.

	9TK320
	9TK316
	9TK312
	9TK306



**1453**

**DESTORNILLADOR PORTA PUNTAS 1/4"**

Flexible



	mm	mm	mm	mm	g	€ <sup>B</sup>
145305	5	9	190	300	136	15€ <sup>B</sup>
145306	6	9	190	300	135	15€ <sup>B</sup>
145307	7	9.3	190	300	134	15€ <sup>B</sup>
145308	8	9.5	190	300	133	15€ <sup>B</sup>
145310	10	9.5	190	300	132	16€ <sup>B</sup>



4  
PZAS

**9TK024**

249€<sup>B</sup>

**JUEGO DE PALANCAS DE FUERZA**

Contiene

9.34

Para grandes esfuerzos. Incluye una palanca recta y palancas curvadas a 90°, 45° y 30° para todo tipo de trabajo. Palancas extra largas para más potencia.

	9TK225A, 90°
	9TK225B, 45°
	9TK236A, 30°
	9TK236B, 0°

# DESTORNILLADORES DE CARRACA



9 PZAS

**32809MR** 1/4" 26€ B

## JUEGO DE DESTORNILLADOR DE CARRACA ARTICULADO CON PUNTAS

Contiene		300
⊖	1/4" 1025S	4, 5
⊕	1/4" 1025P	PH1, PH2, PH3
⊗	1/4" 1025Z	PZ1, PZ2
75060	2166DF	



55 PZAS

**2555MR** 1/4" 71€ B

## COFRE DESTORNILLADOR DE CARRACA ARTICULADO CON PUNTAS Y VASOS 1/4"

Empuñadura articulada, ideal para los sitios con acceso difícil

Contiene		1
⊖	1/2" 2335M	4, 4.5, 5, 5.5, 6, 7, 8, 9, 10, 11, 12, 13, 14
⊖	1/4" 1025S	3, 4, 4.5, 5, 5.5, 6, 6.5, 8
⊕	1/4" 1025P	PH0, PH1, PH2, PH3
⊗	1/4" 1025Z	PZ0, PZ1, PZ2, PZ3
⊗	1/4" 1025U	T10H, T15H, T20H, T25H, T27H, T30H, T40H
⊗	1/4" 1025H	H2, H2.5, H3, H4, H5, H6, H8
⊗	1/4" 1025T	T10, T15, T20, T25, T27, T30, T40
⊗	1/4" 1025R	RB1, RB2
770225	75060	
2166DF		

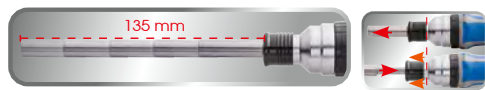

Porta punta magnético telescópico



Apretar, aflojar y bloquear



8 PZAS

**32808MR** 1/4" 25€ B

## JUEGO DE DESTORNILLADORES DE CARRACAS 8 EN 1

Contiene		270
⊕	1/4" 1025P	PH1, PH2
⊗	1/4" 1025Z	PZ2
⊖	1/4" 1025S	4.0 x 0.5, 5.5 x 0.8, 6.5 x 1.2
215506	2155DF	

# ADAPTADOR ANGULAR

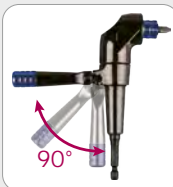

**759140** 42€ B

## ADAPTADOR ANGULAR 1/4" PARA ATORNILLADOR

Para puntas, muelas, funda pulidora. Porta puntas magnético. Empuñadura con 24 posiciones. Ángulo de 90°. Para atornillador desde 18V hasta 24V. Espacio de almacenaje para una punta incluido en la empuñadura. Largo: 140 mm.



120 x 70 x 42 mm

**32540MR** 1/4" 49€ B

Contiene		270
⊖	1/4" 1025S	3.0, 4.0 (x2), 5.0, 5.5, 6.0, 6.5
⊕	1/4" 1025P	PH1 (x2), PH2 (x3), PH3
⊗	1/4" 1025Z	PZ1, PZ2 (x2), PZ2, PZ3
⊗	1/4" 1025T	T10, T15, T20, T25, T27, T30, T40
⊗	1/4" 1025U	T10H, T15H, T20H, T25H, T27H, T30H, T40H
⊗	1/4" 1025H	H3, H4, H5, H6
75363	770225	
2155DF	215506	



\*Garantía ilimitada, excluyendo las puntas 1/4".

Oferta válida del 01/01/2025 al 31/12/2025. Precio recomendado de venta al público en euros sin IVA. Fotos no contractuales.



# DESTORNILLADOR DE GOLPE

¿Tornillos y pernos atascados? ¡Piense en el destornillador de golpe!

La fuerza de impacto libera tornillos oxidados o atascados sin dañarlos. Empuñadura con 2 zonas moleteadas antideslizantes para un agarre sólido y seguro. Práctico, se puede utilizar en cualquier lugar, ya que no se requiere ninguna fuente de alimentación externa.



2 PZAS

4116FR01

1/2" 3/4"

61€<sup>B</sup>

## JUEGO DE DESTORNILLADOR DE GOLPE 3/4" Y REDUCTOR 1/2"

Par máximo del adaptador para vasos 1/2": 512 Nm. Empuñadura con funciones de apriete / afloje.

Contiene	1.27
4116 (3/4")	6814 (3/4" → 1/2")



10 PZAS

4505MR

5/16"

48€<sup>B</sup>

## CAJA DE DESTORNILLADOR DE GOLPE Y ACCESORIOS

Contiene		1.6
5/16" 1836P PH2, PH3	5/16" 1836S	9, 11
1/2" 4335M 8, 10, 12, 14		
4112 (1/2")	4148 (1/2" → 5/16")	

# PUNTAS



10 PZAS

1010MQ01 1/4" 9,30€<sup>B</sup>

Contiene	710
1/4" 7150S 6.5, 5.5, 4.5	
1/4" 7100P PH1, PH2, PH3	
1/4" 7100Z PZ1, PZ2, PZ3	
1/4" 75060	



11 PZAS

1011MQ 23,70€<sup>B</sup>

Contiene	820
10 mm (L: 36 mm) 1636M	M5, M6, M8, M10, M12
10 mm (L: 80 mm) 1680M	M5, M6, M8, M10, M12
1/2" 414810M	



10 PZAS

1010PQ01 1/4" 9,60€<sup>B</sup>

Contiene	690
1/4" 7100T T8, T9, T10, T15, T20, T25, T27, T30, T40	
1/4" 75060	



23 PZAS

1023EQ 44€<sup>B</sup>

Contiene	1.36
10 mm (L: 36 mm) 1636E	10IP, 15IP, 20IP, 25IP, 27IP, 30IP, 40IP, 45IP, 50IP, 55IP, 60IP
10 mm (L: 80 mm) 1680E	10IP, 15IP, 20IP, 25IP, 27IP, 30IP, 40IP, 45IP, 50IP, 55IP, 60IP
1/2" 414810M	



43 PZAS

1043CQ 76€<sup>B</sup>

Versión impacto.

Contiene	2.42
10 mm (L: 36 mm) 1636H	H4, H5, H6, H7, H8, H10, H12
10 mm (L: 80 mm) 1680H	H4, H5, H6, H7, H8, H10, H12
10 mm (L: 36 mm) 1636M	M5, M6, M8, M10, M12
10 mm (L: 80 mm) 1680M	M5, M6, M8, M10, M12
10 mm (L: 36 mm) 1636T	T20, T25, T27, T30, T40, T45, T50, T55, T60
10 mm (L: 80 mm) 1680T	T20, T25, T27, T30, T40, T45, T50, T55, T60
1/2" 414710M	

\*Garantía ilimitada, excluyendo las puntas 1/4".

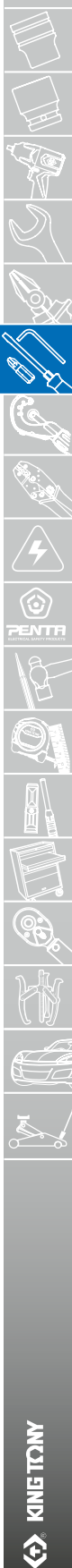

New

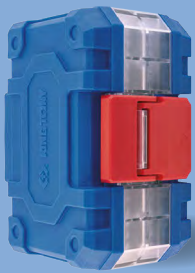

CAJA DE PP  
LIGERA Y  
COMPACT



41  
PZAS

**1041CQ02EB** 10 mm **86€<sup>B</sup>**

CAJA DE PUNTAS 10 MM

Contiene

2.1

		1636M	M5, M6, M8, M9, M10, M12, M14
		1636T	T10, T15, T20, T25, T27, T30, T40, T45, T50, T55, T60
		1636H	H5, H6, H8, H10
		1680M	M5, M6, M8, M9, M10, M12, M14
		1680T	T10, T15, T20, T25, T27, T30, T40, T45, T50, T55, T60
		414810M	

New



S2

6  
PZAS

**1004A6HQ** **6€<sup>B</sup>**

Contiene

90

1/4" 7150H H2, H2.5, H3, H4, H5, H6



S2

6  
PZAS

**1004A6TQ** **6,50€<sup>B</sup>**

Contiene

90

1/4" 7100T T15, T20, T25, T27, T30, T40

**1004D6TQ** **13,50€<sup>B</sup>**

Contiene

200

1/4" 7100T T15, T20, T25, T27, T30, T40



120 x 70 x 42 mm

S2 **32  
PZAS**

**1032CQ** 1/4" **28€<sup>B</sup>**

Contiene

300

		1/4" 1025S	3, 4, 5, 6
		1/4" 1025P	PH1, PH2, PH2, PH3
		1/4" 1025Z	PZ1, PZ2, PZ2, PZ3
		1/4" 1025T	T10, T15, T20, T25, T27, T30, T40
		1/4" 1025U	T10H, T15H, T20H, T25H, T27H, T30H, T40H
		1/4" 1025H	H3, H4, H5, H6
		75363	770225



150 x 102 x 46 mm

S2 **49  
PZAS**

**1049CQ10** 1/4" **39€<sup>B</sup>**

Contiene

510

		1/4" 1025P	PH1 x 2, PH2 x 2 ø6mm, PH2 x 2 ø4.7mm, PH3 x 2
		1/4" 1025S	4.0 x 2, 5.5 x 2, 6.5 x 2
		1/4" 1025Z	PZ1 x 2, PZ2 x 2, PZ3 x 2
		1/4" 1025T	T9, T10, T15, T20, T25, T27, T30, T40
		1/4" 1025H	H2, H2.5, H3, H4, H5, H6, H7, H8
		1/4" 1025U	T9H, T10H, T15H, T20H, T25H, T30H, T40H
		1/4" 1025R	RB1, RB2
		1/4" 2142	2142
		1/4" 770	770225
		1/4" 750A	75050A



150 x 102 x 46 mm

S2 **49  
PZAS**

**1048MR** 1/4" **59€<sup>B</sup>**

Contiene

530

		1/4" 1025S	3 x 0.5, 4 x 0.5, 5 x 0.8, 6 x 1
		1/4" 1025P	PH1 x 2, PH2 x 2 ø6mm, PH3, PH2 ø4.7mm
		1/4" 1025T	T10, T15, T20 x 2, T25, T27, T30, T40
		1/4" 1025H	H3, H4, H5, H6
		1/4" 1025U	T10H, T15H, T20H x 2, T25H, T27H, T30H, T40H
		1/4" 1025Z	PZ2 x 2
		1/4" 7150T	T15, T20, T25
		1/4" 7150S	4.0 x 0.8, 6.0 x 1.0
		1/4" 7150H	H3, H4, H5, H6, H7, H8
		1/4" 7150P	PH2 x 2
		1/4" 7150Z	PZ2
		75075	75363
			2746

\*Garantía ilimitada, excluyendo las puntas 1/4".

Oferta válida del 01/01/2025 al 31/12/2025. Precio recomendado de venta al público en euros sin IVA. Fotos no contractuales.

**Mini**

**Serie ATOM**

140 x 65 x 36 mm

S2 **26 PZAS**

**1026CQAM 1/4"** 51€ <sup>B</sup>

Contiene  $\Delta$  390

	1/4"	1025H	H3, H4, H5, H6, H8
	1/4"	1025T	T10, T15, T20, T25, T27, T30, T40
	1/4"	1025Z	PZ1, PZ2, PZ3
	1/4"	1025P	PH1, PH2, PH3
	1/4"	1025U	T10H, T15H, T20H, T25H, T30H

276B35 75363 770225

**7 PZAS**

**P2746 1/4"** 19€ <sup>B</sup>

Contiene  $\Delta$  150

	1/4"	1025S	4.0 x 0.5, 5.5 x 0.8, 6.5 x 1.2
	1/4"	1025P	PH1, PH2
	1/4"	1025Z	PZ2

2746



**New**

Disponible a finales de marzo

**753B280D1 1/4"** 200 ~ 280 mm  $\Delta$  170

**PORTAPUNTAS MAGNÉTICO TELESCÓPICO 1/4"** 31€ <sup>B</sup>

La función de cierre rápido mejora la eficacia del trabajo. Tire del anillo de bloqueo hacia delante para ajustar la longitud.

**New**

**1010CMR 1/4"** 89€ <sup>B</sup> **10 PZAS**

**JUEGO DE VASOS HEXAGONALES LARGOS PARA DESTORNILLADOR**

Longitud total de 110 mm, ideal para grandes profundidades. Toma de 63 mm de profundidad para muchos tornillos. Ideal para destornilladores.

Contiene

76C 8, 10, 12, 13, 14, 17, 19, 21, 23, 24

257 x 200 x 52 mm

**CROMO VANADIO**

**761M 1/4"**

	$\varnothing$ mm	L mm	$\Delta$
7611008M	8	100	54
7611010M	10	100	54
7611012M	12	100	63
7611013M	13	100	71

4,10€ <sup>B</sup>

**KING TONY** no.9103PR

**3PC. POWER BIT SOCKET ADAPTER SET**

1/2" 3/8" 1/4"

Seguridad por bola

**3 PZAS**

**9103PR 1/4"** 8€ <sup>B</sup>

**JUEGO DE PORTA VASOS CON BOLA DE SEGURIDAD**

Contiene  $\Delta$  90

1/4"	770250
3/8"	770350
1/2"	770450

Descubra toda la serie 761M.



# LLAVES MACHO HEXAGONALES

**201A09MR**   **9 PZAS**

Ideal para espacios reducidos **30€** <sup>B</sup>

Contiene  450

1.5H, 2H, 2.5H, 3H, 4H, 5H, 6H, 8H, 10H

Longitud reducida en un 33%

20109MR      201A09MR

**20108MR**   **8 PZAS**

Contiene  430

1120MR H2, H2.5, H3, H4, H5, H6, H8, H10

**20109MR**   **9 PZAS**

Contiene  490

1120MR H1.5, H2, H2.5, H3, H4, H5, H6, H8, H10

**201B09MR**   **9 PZAS**

Contiene  490

1120MR H1.5, H2, H2.5, H3, H4, H5, H6, H8, H10

**20109MW**   **9 PZAS**

Contiene  450

H1.5, H2, H2.5, H3, H4, H5, H6, H8, H10

mm	L mm
H1.5	92
H2	102
H2.5	115
H3	129
H4	144
H5	165
H6	186
H8	208
H10	234

**20210MR**   **10 PZAS**

**64€** <sup>B</sup>

Contiene  3.03

1125M H3, H4, H5, H6, H7, H8, H10, H12, H14, H17

**20110MR**   **9 PZAS**

Contiene  390

1130M H1.5, H2, H2.5, H3, H4, H5, H6, H8, H10

**20129SR**   **9 PZAS**

Contiene  390

1130S 1/16", 3/32", 1/8", 5/32", 3/16", 1/4", 5/16", 3/8", 5/64"

### MATERIALES

**SOSTENIBILIDAD**

-  Aleación de acero al Cromo Vanadio
-  Aleación de acero al Cromo Vanadio Silicio
-  Aleación de acero al Silicio Níquel Cromo Molibdeno Vanadio



9 PZAS

SNCM + V

**20319PR**

26€<sup>B</sup>

Contiene 500  
1123R T10, T15, T20, T25, T27, T30, T40, T45, T50



Longitud reducida en un 33%

9 PZAS

SNCM + V

**203A19PR**

32€<sup>B</sup>

Contiene 450  
T10, T15, T20, T25, T27, T30, T40, T45, T50



9 PZAS

SNCM + V

**20419PR**

27€<sup>B</sup>

Contiene 450  
1127R T10H, T15H, T20H, T25H, T27H, T30H, T40H, T45H, T50H



9 PZAS

SNCM + V

**204B29PR**

37€<sup>B</sup>

Contiene 370  
1137BR T10, T15, T20, T25, T27, T30, T40, T45, T50



SNCM + V

5 PZAS

**20505PR01**

19€<sup>B</sup>

Contiene 330  
1146M M5, M6, M8, M10, M12



SNCM + V

5 PZAS

**20515PR01**

27€<sup>B</sup>

Contiene 630  
1126M M5, M6, M8, M10, M12



8 PZAS

SNCM + V

**22218MR**

50€<sup>B</sup>

Contiene 1.1  
1165MR H2, H2.5, H3, H4, H5, H6, H8, H10



9 PZAS

SNCM + V

**22319TR**

56€<sup>B</sup>

Contiene 1.2  
1163TR T10, T15, T20, T25, T27, T30, T40, T45, T50

SNCM + V

8 PZAS

**23208MR**

98€<sup>B</sup>

Contiene 1.64

1195A H2, H2.5, H3, H4, H5, H6, H8, H10

Soporte para colocar o fijar a una pared

ROTACIÓN DE BRAZO LIBRE



8 PZAS

SNCM + V

**21108MR**

40€<sup>B</sup>

Contiene 1.1  
1150MR H2, H2.5, H3, H4, H5, H6, H8, H10



Cr-V

8 PZAS

**24308PR**

24,30€<sup>B</sup>

Contiene 270  
1163A T5, T6, T7, T8, T9, T10, T15, T20



# HERRAMIENTAS DE TUBERÍA

## 6531

### LLAVES PARA TUBOS TIPO STILLSON

Cuerpo y bocadillo forjados. Engranaje tratado HRC 57.



	inch	mm		
653110	34	10	229	600
653112	42	12	270	780
653114	48	14	312	1050
653118	60	18	405	1720
653124	75	24	541	3150
653136	102	36	825	6280
653148	140	48	1034	9750

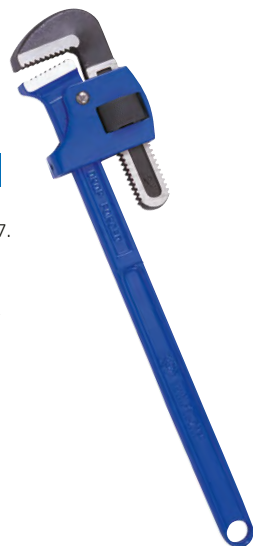

## 6533L

### Aluminio

### LLAVES PARA TUBOS DE ALUMINIO

40% más ligera que los modelos convencionales del mismo tamaño. Rueda de ajuste fácil de girar para un rápido ajuste de tamaño. La mandíbula de acero forjado está tratada térmicamente.



	inch	mm		
653310L	30	10	254	540
653312L	40	12	300	833
653314L	50	14	356	940
653318L	60	18	455	1500
653324L	75	24	600	2500
653336L	85	36	910	5000
653348L	110	48	1200	8000



## 6521

### LLAVES PARA TUBOS TIPO SUECO

Para pernos, tuercas, material plano. Mordazas en forma de 'S'. Tres puntos de presión que garantizan un mejor agarre. Cuerpo de acero forjado de alta calidad.

	inch	mm		
652116	38	16"	420	1450
652121	51	21"	535	2404

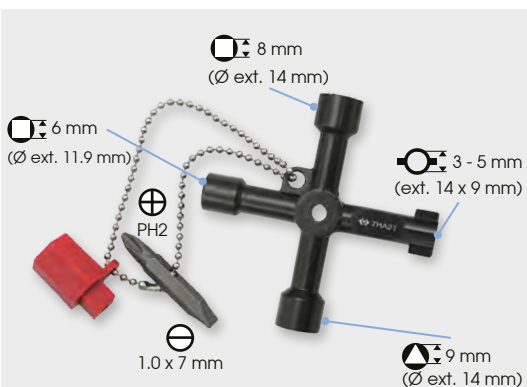

## 7HA21

11,80€<sup>B</sup>

### LLAVE UNIVERSAL DE 4 VÍAS, PARA ARMARIOS DE CONTROL

Para armarios de control, sistemas de cierre de gas, agua y electricidad. Para instalaciones técnicas en edificios tales como aire acondicionado y ventilación, válvulas de cierre, tableros de distribución, etc.



## 7HA03

44€<sup>B</sup>

### CARRACA CON AGUJERO PASANTE Y LLAVE ESCALONADA

Pensado para instalar y quitar la mayoría de las válvulas de radiadores y conectores de depósito. Los hexágonos de 3/8", 11.6 mm, 1/2", 3/4" y 1", dispuestos a lo largo de la llave, son adecuados para diferentes tamaños de electroválvulas y válvulas.

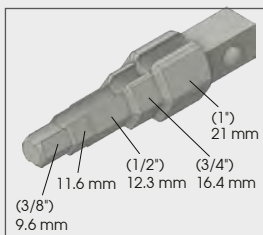

# CORTA TUBO

10  
PZAS



791221

791222



791223

## CORTA TUBOS CON CARRACA

Corta sin tener que girar la herramienta completamente alrededor del tubo. El mecanismo de carraca permite su uso en áreas estrechas. Corta los materiales más resistentes: acero inoxidable, cobre y aluminio. Sin desbarbador.

	Capacidad ø mm	Grosor de corte máx. (mm)			Peso g	Precio € B
		Inoxidable	Otro	Aluminio		
791221	8 ~ 28	2	3.0	389	53€ B	
791222	12 ~ 35	2	3.0	452	62€ B	
791223	28 ~ 67	2	3.0	1122.6	146€ B	



7CA0110S

74€ B

Contiene		Peso g
791530	3-30 mm 1/8"-1-1/8"	1.68
7CA22P20S	3/16", 1/4", 5/16", 3/8", 7/16", 1/2", 5/8"	
7CA22P01		
Insertos con adaptadores	3/16", 1/4", 5/16", 3/8", 7/16", 1/2", 5/8"	

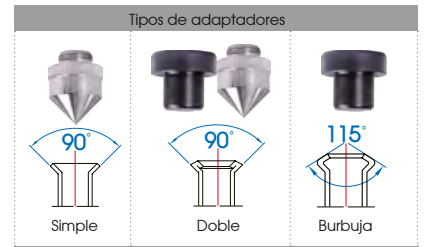

Desbarbador.

7914A35

27,50€ B

7914C70

68€ B

Capacidad ø mm	Grosor de corte máx. (mm)	Largo mm	Peso g
3 ~ 35	1.2	140	333

Capacidad ø mm	Grosor de corte máx. (mm)	Largo mm	Peso g
6 ~ 70	1.2	222	802

## CORTATUBOS PARA COBRE

Mango ergonómico para un uso cómodo. Incluye rueda de corte de repuesto. Con 4 rodillos para un guiado perfecto del tubo. Detener para evitar que la rueda y los rodillos entren en contacto.



# PRECISIÓN

## DESTORNILLADORES DE PRECISIÓN



**32607MR**

25€<sup>B</sup>

**CAJA DE DESTORNILLADORES DE PRECISIÓN CON VARILLAS REVERSIBLES**

Contiene

290



**32309PR**

30€<sup>B</sup>

Contiene

260

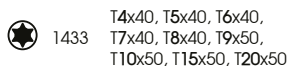

**32108MR**

25€<sup>B</sup>

Contiene

290

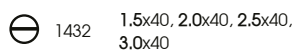

## ALICATES DE PRECISIÓN



- Alambre blando: ø2.0mm
- Alambre semiduro: ø1.6mm

**620705**

12€<sup>B</sup>

**ALICATE CORTANTE DE PRECISIÓN DE CORTE DIAGONAL**



- Alambre blando: ø2.0mm
- Alambre semiduro: ø1.6mm

**631706**

12,50€<sup>B</sup>

**ALICATE DE PRECISIÓN CON BOCA SEMI REDONDA**

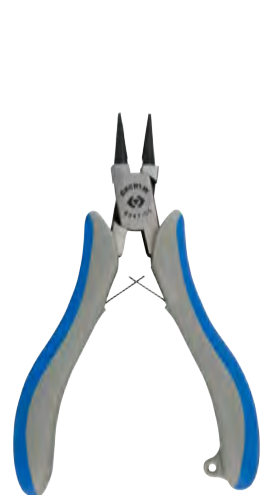

**634705**

12,60€<sup>B</sup>

**ALICATE DE PRECISIÓN CON BOCA REDONDA CORTA**

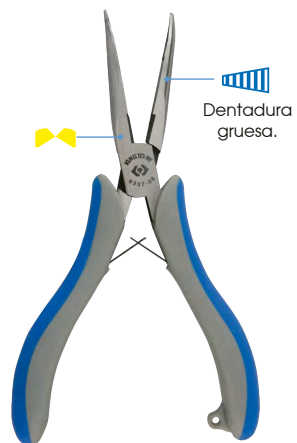

- Alambre blando: ø2.0mm
- Alambre semiduro: ø1.6mm

**633706**

12€<sup>B</sup>

**ALICATE DE PRECISIÓN CON BOCA SEMI REDONDA ACODADA**



**42207GP**

103€<sup>B</sup>

**JUEGO DE ALICATES DE PRECISIÓN**

Contiene

652

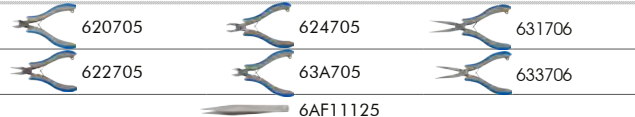



**794507** 13,60€<sup>B</sup>

**CÚTER PLEGABLE CON DOBLE CUCHILLAS**

Selección de la cuchilla

cuchilla trapezoidal

cuchilla de gancho

171 mm

Con clip para el cinturón

157.5

QR code

Botón grande

Bloqueo seguro con rueda

117

**797707** 7,50€<sup>B</sup>

**CÚTER**

Sistema de bloqueo de la cuchilla mejorado. Cuchilla de acero de carbono SK4, dureza HRC  $\geq 65$ . Tratamiento de la cuchilla : técnica de endurecimiento por láser para una alta dureza del filo de corte. Cuchilla con revestimiento negro. Grosor de la cuchilla: 0,7 mm. Anchura de la cuchilla: 18 mm. Largo: 180 mm.

180 mm

QR code

**NAVAJAS**

Apertura rápida.

Cierre de seguridad

Con clip para el cinturón

**794108A** 26€<sup>B</sup>

**NAVAJA CON MUELLE DE BLOQUEO**

El cierre de seguridad evita que la hoja se pliegue en el mango después de abrirla. Ligera y cómoda de usar. Hoja de acero inoxidable con revestimiento negro.

210 mm

90 mm 120 mm

173

180 mm

Estructura de aleación de zinc

1

2

**794607** 14,80€<sup>B</sup>

**CÚTER DE SEGURIDAD CON CUCHILLA AUTO-RETRÁCTIL**

2 en 1: elija entre la función auto-retráctil (1) o bloquear la cuchilla manualmente (2).

Cortahilos

TPR antideslizante

Depósito de cuchillas (2 cuchillas incluidas) Compatible con las cuchillas 794507P01.

Cuchillas trapezoidales de 60 x 18 mm, de acero de carbono SK5.

**797707P02** 4,70€<sup>B</sup>

**JUEGO DE CUCHILLAS DE CÚTER DIVISIBLES**

Anchura de la cuchilla: 18 mm. Cuchilla de acero de carbono SK4. Para 797707 y 797807. Tratamiento de la cuchilla : técnica de endurecimiento por láser para una alta dureza del filo de corte.

10 PZAS

**797807P02** 3,50€<sup>B</sup>

**JUEGO DE CUCHILLAS DE CÚTER DIVISIBLES**

Anchura de la cuchilla: 18 mm. Cuchilla de acero de carbono SK4. Para 797707 y 797807.

10 PZAS

175 mm

135

**797807** 5,60€<sup>B</sup>

**CÚTER CON CARGADOR AUTOMÁTICO**

Función de recarga automática de la cuchilla. Cuchilla de acero de carbono SK4, dureza HRC  $\geq 62$ . Grosor de la cuchilla: 0,5 mm. Anchura de la cuchilla: 18 mm.

Cargador integrado de 3 cuchillas divisibles.

# TIJERAS

Acero inoxidable 420J2  
(HRC 52-55)

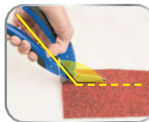

El gran ángulo entre la empuñadura y las láminas permite que la mano del usuario nunca toque el soporte durante el corte.

**6AB1465**

34€<sup>B</sup>

## TIJERAS MULTIUSO

Tijeras diseñadas para cortar materiales blandos como láminas de estaño, plásticos, cartón, papel, etc.

Capacidad de corte:

- hilo de aluminio: 2.5 mm
- hilo de cobre: 2.5 mm
- cartón: 10 mm
- alfombra: 5 mm
- cobre: 0.5 mm
- aluminio blando: 0.6 mm



Acero inoxidable 4034  
(HRC 54-55)

Cortacables en ambas láminas de hasta 80 mm<sup>2</sup> (AWG : 3/0)

Lámina microdentada antideslizante de 21 mm



2 ranuras de pelacable: 1.5, 2.5 y 4 mm (AWG : 16, 14, 12)

**6AB1465**

34€<sup>B</sup>

## TIJERAS PARA ELECTRICISTA MULTIFUNCIÓN

Estructura totalmente de acero, duradera y muy resistente.

Acero inoxidable 4034  
(HRC 54-55)

Cortacables en ambas láminas de hasta 50 mm<sup>2</sup> (AWG : 3/0)

Lámina microdentada antideslizante de 24 mm



2 ranuras de pelacable: 1.5 y 2.5 mm (AWG : 12, 14)

**6AB1406**

28€<sup>B</sup>

## TIJERAS PARA ELECTRICISTA MULTIFUNCIÓN

Estructura totalmente de acero, duradera y muy resistente.

Acero inoxidable



**6AB1255**

11,80€<sup>B</sup>

## TIJERAS PARA ELECTRICISTA

Capacidad de corte

- cable eléctrico: 10 mm
- cartón: 10 mm
- caucho: 10 mm
- cuero: 10 mm
- acero laminado: 0.5 mm
- cobre: 0.5 mm
- aluminio: 0.5 mm



Acero inoxidable AUS-8 (59 HRC)



**6AB1306**

24€<sup>B</sup>

## TIJERAS PARA ELECTRICISTA

Alto rendimiento de corte con poco esfuerzo.



**6AB3175**

11,50€<sup>B</sup>

## TIJERAS MULTIUSO



# HERRAMIENTA PARA ELECTRICISTA

Autorización  
CAT IV 1000,  
EN 61010-1 : 2010/A1 : 2019,  
EN 62471 : 2008,  
EN 61326-1 : 2013,  
EN 61326-2-2 : 2013

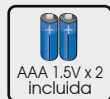

AAA 1.5V x 2  
incluida

Lámpara  
COB LED

Magnética

Bloqueo

Detector de  
voltaje sin  
contacto  
80 - 1000 V  
AC



Destornillador  
PH2 x1  
(65-70 mm)

Corta hilo  
Ø 7 mm

Pelacables  
Romex®  
tipo NM-B  
12/2

Pelacable  
0.5 ~ 8 mm²  
8 ~ 20 AWG

Ajuste de la  
longitud de  
pela cable



**6CB41**

80~1000 V

59€<sup>B</sup>

**PELACABLES MULTIFUNCIÓN 9 EN 1**

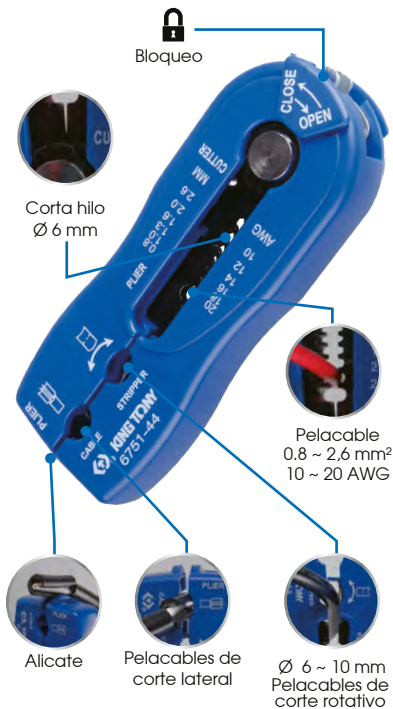

Bloqueo

Corta hilo  
Ø 6 mm

Pelacable  
0.8 ~ 2.6 mm²  
10 ~ 20 AWG

Alicate

Pelacables de  
corte lateral

Ø 6 ~ 10 mm  
Pelacables de  
corte rotativo

**675144**

18,40€<sup>B</sup>

**PELACABLES MULTIFUNCIÓN**



220 mm

7  
PZAS



**42107GX**

139€<sup>B</sup>

**MALETÍN DE ALICATE DE ENGASTAR  
CON CARRACA - MATRICES  
INTERCAMBIABLES**

Sistema de cremallera garantizando un  
engaste completo.

**New**



Para terminales sin  
aislamiento.



**6AC5212**

41€<sup>B</sup>

**HERRAMIENTA DE  
ENGASTE PARA  
TERMINALES NO AISLADOS**

Diseño de carraca.

Capacidad de engaste

AWG	16	14	10	8	6
JIS (mm²)	1.25	2	5.5	8	14
DIN (mm²)	1.5	2.5	6	10	16

**New**

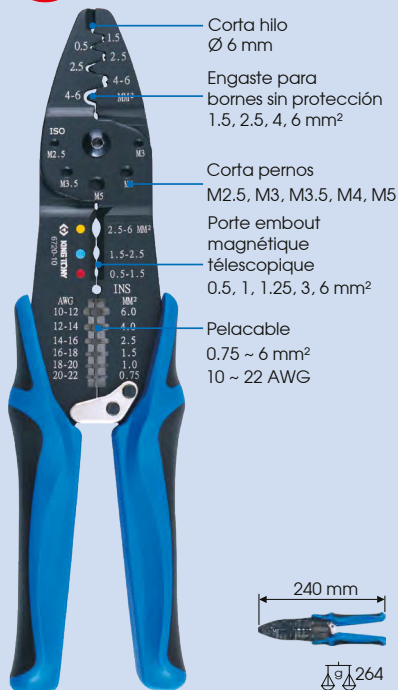

Corta hilo  
Ø 6 mm

Engaste para  
bornes sin protección  
1.5, 2.5, 4, 6 mm²

Corta pernos  
M2.5, M3, M3.5, M4, M5

Porte embout  
magnétique  
télescopique  
0.5, 1, 1.25, 3, 6 mm²

Pelacable  
0.75 ~ 6 mm²  
10 ~ 22 AWG

240 mm



**672010**

32€<sup>B</sup>

**ALICATE DE ENGASTAR ESTÁNDAR  
PARA BORNES PRE AISLADOS**

**6AG120**

1,90€<sup>B</sup>

**CINTA AISLANTE DE PVC**

Largo: 18 m  
Largo: 18 mm

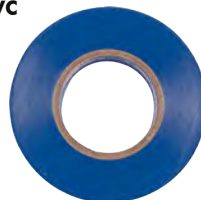

Corta hilo  
Ø 5 mm

Pelacables  
0.05 ~ 3.5 mm²  
30 ~ 12 AWG



**67A107**

18€<sup>B</sup>

**PELACABLES AUTOMÁTICO**



Pelacables  
0.2 ~ 6.0 mm²  
24 ~ 10 AWG

Corta hilo  
Ø 6 mm

Engaste de terminales  
aislados  
0.5 ~ 6 mm²  
22 ~ 10 AWG



**676208**

21€<sup>B</sup>

**PELACABLES AUTOMÁTICO**



**6AC5126**

**ALICATE DE ENGASTAR - GRANDES ESFUERZOS**

Para bornes de 10 mm<sup>2</sup> hasta 150 mm<sup>2</sup>.  
Reglaje por tornillo.

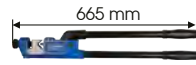

174€<sup>B</sup>



Capacidad de engaste

AWG	8	6	4	2	1/0	2/0	3/0	4/0	300MCM
JIS (mm <sup>2</sup> )	8	14	22	38	60	70	80	100	150
DIN (mm <sup>2</sup> )	10	16	25	35	50	70	95	120	150

3.9



**67E208**

24€<sup>B</sup>

**ALICATE PARA ABRAZADERAS DE PLÁSTICO**

Corte manual del sobrante de la abrazadera.  
Gran recorrido para una aproximación rápida.  
Para cualquier abrazadera de 2,4 a 9 mm de ancho. Para colocar las abrazaderas de manera rápida.

257



**SOLDADURA**



16

**6AF11125**

3,90€<sup>B</sup>

**PINZA**



26

**6AF21165**

3,80€<sup>B</sup>

**PINZA CRUZADA**

Puntas semi redondas de acero inoxidable.  
Para la sujeción de piezas pequeñas durante el proceso de soldadura o la limpieza.  
Pinza cruzada «auto apriete».  
Acabado pulido.



DIA : Ø 1.0 mm

250

**6BF1125**

26€<sup>B</sup>

**ALAMBRE DE SOLDAR**

Composición: 60% estaño, 40% plomo.  
Para uso sobre circuito electrónico.  
Pelacables incorporado en el hilo.  
Flujo resinoso A11 (sin limpieza activada) incorporado en el hilo.



**6BC3007**

63€<sup>B</sup>

**SOLDADOR DE GAS**

Potencia : 30W -150W.  
Sin cable.  
4 opciones de soldadura diferentes.  
Rango de temperatura ajustable: de 400°C hasta 450°C.  
Depósito de gas de 20ml para 90 minutos de utilización.  
Temperatura del soplete de aire caliente: 1300°C (2400°F).  
Recargable con gas butano : 20ml.  
Se puede utilizar 45 segundos después de tenerlo encendido.

340



8 PZAS



83.2

**6BC141**

33€<sup>B</sup>

**SOLDADOR**

220V / 240V, 30W.  
Para trabajos eléctricos y vidrieras.  
Empuñadura ligera.  
Punta del cabezal intercambiable.  
Electrodo de recambio (6BC1411).



41.8

**6BD11**

6€<sup>B</sup>

**BOMBA PARA QUITAR LA SOLDADURA**

Bomba para quitar la soldadura mecánica con una fuerte aspiración.  
Cuerpo plástico ABS.  
Punta intercambiable (6BD111).

# CONTROLADOR DE TENSIÓN

**New**



160 x 20 x 24 mm

EN 61000-6-3 / EN 61000-6-1 CAT III.

**6CB31**

80~1000V AC

20€<sup>B</sup>

## COMPROBADOR DE TENSIÓN SIN CONTACTO



Rango de tensión: de 80 a 1000 V CA (50-60 Hz).  
Sensibilidad ajustable.  
Localiza tensiones eléctricas en cables y enchufes.  
Detecta roturas de líneas en hilos y cables.  
Apagado con sólo pulsar un botón.  
Baja tensión (L): luz roja.  
Alta tensión (H): luz verde.



AAA 1.5V x 2  
no incluidas



**9DC242**

6~24V DC

48€<sup>B</sup>

## COMPROBADOR DE CIRCUITO CON PANTALLA DIGITAL

Comprueba tensiones de 6V, 12V y 24V. Para uso exclusivo en circuitos DC.  
Sonda resistente de acero inoxidable que permite saber si el circuito tiene alimentación eléctrica.  
Sin pilas, este comprobador se alimenta de la electricidad del circuito que comprueba.  
Cable espiral estirable hasta 3m.  
Pinza de cocodrilo aislada. Normas CE EN 61000-6-3(2007), EN 61000-6-1(2007).



No usar en  
airbags.

**9DC22**

6~24V DC

7,90€<sup>B</sup>

## COMPROBADOR DEL CIRCUITO

Comprobador de voltaje de 6 a 24 V.  
Aplicación solamente sobre circuito DC.  
Test por diodo luminoso.  
Tapón protector de la aguja.  
Bombilla intercambiable (24V/3W).  
Hilos de 90 cm. Cuerpo de bronce.



**9DC23**

3~48V DC

11€<sup>B</sup>

## CONTROLADOR DE TENSIÓN

Comprobador de voltaje de 3 a 48V. Aplicación solamente sobre circuito DC. Pinza cocodrilo aislada con cable de 150 cm. Indicador 2 LED (positivo y negativo).

2 posiciones de prueba:



**6CB21**

## COMPROBADOR DIGITAL DE VOLTAJE

Para comprobar rápidamente y con seguridad las tensiones altas y bajas sobre motores, coches, energías hidroeléctricas, etc. Prueba autodiagnóstico. Indicador de polaridad. Detección e indicador de fases. Indicador del sentido de rotación de las fases. Luz LED integrada. Pantalla LCD.

### INFORMACIÓN TÉCNICA

Test de tensión DC	12, 24, 50, 120, 230, 400, 690V
Test de tensión AC	12, 24, 50, 120, 230, 400, 690V
Indicador de tensión alta	≥ 50V
Rango de frecuencia	0-70Hz
Test de continuidad	0~550kΩ
Temperaturas de funcionamiento	-10~55°C
Dimensión	255 x 66 x 30 mm
Peso	250 g
Autorización	EN 61243-3 / IEC 61243-3, EN 61010-1 / IEC 61010-1, CAT.III 690V / CAT.IV 690V



AAA 1.5V x 2  
incluida

# HERRAMIENTAS DE MEDICIÓN



**9DM1371** 166€<sup>B</sup>



## MULTÍMETRO DIGITAL

Copia de seguridad de los valores, rango automático, selección de desconexión eléctrica automática. Indicador de unidad y función. Protección 600 V.



### INFORMACIÓN TÉCNICA

Voltaje DC (0.1mV ~ 1V)	400mV / 4V / 40V / 400V / 600V
Voltaje AC (0.001V ~ 1V)	400mV / 4V / 40V / 400V / 600V
Amperio DC (0.1uA ~ 0.01A)	400uA / 4000uA / 40mA / 400mA / 10A
Amperio AC (0.1uA ~ 10A)	400uA / 4000uA / 40mA / 400mA / 10A
Resistencia (0.1Ω ~ 20MΩ)	400Ω / 4kΩ / 40kΩ / 400kΩ / 4MΩ / 40MΩ
Frecuencia (1Hz ~ 10kHz)	4 KHz / 40kHz / 400kHz / 4MHz / 40 MHz
Comprobación de continuidad	sí Prueba de diodo sí
Indicador de batería baja	sí
Pantalla LCD	3-1/2 dígitos 1999 puntos
Indicador de sobrecarga	OL
Dimensión	150 x 70 x 35 mm
Peso	300 g
Autorización	CE IEC1010-1CAT II



**9DM1361** 75€<sup>B</sup>



## MULTÍMETRO DIGITAL

Se apaga automáticamente. Selección automática de los calibres. Indicador de polaridad negativa (no hay indicador de polaridad positiva). Consumo energético bajo.



### INFORMACIÓN TÉCNICA

Voltaje DC (0.1mV ~ 600V)	200mV / 2V / 20V / 200V / 600V
Voltaje AC (0.001V ~ 600V)	2V / 20V / 200V / 600V
Amperio DC (0.1uA ~ 10A)	200uA / 2000uA / 20mA / 2A / 10A
Amperio AC (0.1uA ~ 10A)	200uA / 2000uA / 20mA / 2A / 10A
Resistencia (0.1Ω ~ 20MΩ)	200Ω / 2kΩ / 20kΩ / 200kΩ / 2MΩ / 20MΩ
Comprobación de continuidad	sí Prueba de diodo sí
Indicador de batería baja	sí Hfe(NPN, PNP) sí
Pantalla LCD	3-1/2 dígitos 1999 puntos
Tasa de muestreo	3 veces / segundo
Dimensión	138 x 70 x 32 mm
Peso	262 g
Autorización	CE EN61010-1, 600V CATII, 300V CATIII



**9DM2351** 139€<sup>B</sup>



## ALICATE AMPERÍMETRO AC

Indicador de sobrecarga: "OL" y bip. Tamaño máximo del alicate: Ø 30 mm. Indicador de polaridad negativa (no hay indicador de polaridad positiva). Interrupción automática después de 15 minutos sin usar aproximadamente. Consumo energético bajo. Hilos de test amovibles, utilización fácil. Suministrado con estuche de protección.



### INFORMACIÓN TÉCNICA

Amperio AC (0.1A - 1A)	200A / 600A
Voltaje AC (0.001V - 1V)	2V / 20V / 200V / 600V
Voltaje DC (0.1mV - 1V)	200mV / 2V / 20V / 200V / 600V
Resistencia (0.1Ω - 0.01MΩ)	200Ω / 2kΩ / 20kΩ / 200kΩ / 2MΩ / 20MΩ
Comprobación de continuidad	sí Prueba de diodo sí
Indicador de batería baja	sí
Pantalla LCD	3-1/2 dígitos 1999 puntos
Tasa de muestreo	3 veces / segundo
Dimensión	117 x 76 x 18 mm
Peso	354 g
Autorización	CE IEC 61010-1, IEC 61010-2-032 CAT.III 600V Nivel de contaminación 2



**9DM2352 AC y DC** 199€<sup>B</sup>



## ALICATE AMPERÍMETRO AC/DC

Indicador de sobrecarga: "OL" y bip. Tamaño máximo del alicate: Ø 30 mm. Indicador de polaridad negativa (no hay indicador de polaridad positiva). Interrupción automática después de 15 minutos sin usar aproximadamente. Consumo energético bajo. Hilos de test amovibles, utilización fácil. Suministrado con estuche de protección.



### INFORMACIÓN TÉCNICA

Amperio AC (0.1A - 1A)	400A / 600A
Amperio DC (0.1A - 1A)	400A / 600A
Voltaje AC (0.001V - 1V)	4V / 40V / 400V / 600V
Voltaje DC (0.1mV - 1V)	400mV / 4V / 40V / 400V / 600V
Frecuencia Hz	5Hz / 50Hz / 500Hz / 5kHz / 50kHz / 100kHz
Resistencia (0.1Ω - 0.01MΩ)	400Ω / 4kΩ / 40kΩ / 400kΩ / 4MΩ / 40MΩ
Comprobación de continuidad	sí Prueba de diodo sí
Indicador de batería baja	sí
Pantalla LCD	3-1/2 dígitos 1999 puntos
Tasa de muestreo	3 veces / segundo
Dimensión	117 x 76 x 18 mm
Peso	402 g
Autorización	CE IEC 61010-1, IEC 61010-2-032 CAT.III 600V Nivel de contaminación 2



**9DN12** 116€<sup>B</sup>

## TERMÓMETRO DE INFRARROJOS

Mide sin contacto. Punto de mira láser preciso. Utilización segura y sencilla con 4 botones: selector de emisividad 0.85/0.90/0.95, selector °C/°F, punto de mira láser ON/OFF, retroiluminación ON/OFF.



### INFORMACIÓN TÉCNICA

Rango de temperaturas	-30 a 550°C (-22 a 1022°F)
Temperatura de funcionamiento	0~50° C
Humedad	80% RH
Resolución	0.1°C / 0.1°F
Precisión Infrarrojo	±2.5% o 3°C
Emisividad	0.85 / 0.90 / 0.95 (ajuste digital)
Distancia al foco	12:1
Bloqueo automático	15 segundos
Seguridad	Láser de clase 2 (potencia < 1 mW)
Dimensión	193 x 47 x 126 mm
Peso	313 g





GARANTÍA ILIMITADA



# HERRAMIENTAS AISLADAS DE 1000 V CERTIFICACIÓN VDE Y GS



#9 (280 x 375 mm) IEC 60900:2012, VDE/GS

**955VE01MRV** 1/4" + 3/8" **585€<sup>B</sup>**

Contiene		1.30
	2335VE 5, 6, 7, 8, 9, 10, 11, 12, 13, 14	
	2035VE H3, H4, H5, H6	
	2221VE04, 2221VE06	
	2771VE55	2178VE05
	3335VE 10, 11, 12, 13, 14, 15, 16, 17, 18, 19	
	3235VE 8, 10, 12, 14	
	3025VE H8, H10	
	3221VE06, 3221VE10	
	3771VE08	3178VE08



372 x 422 x 92 mm

**30VE31MPV** **499€<sup>B</sup>** **31 PZAS**

Contiene		4.21
	3335VE 6, 7, 8, 9, 10, 11, 12, 13, 14, 15, 16, 17, 18, 19	
	10FOVE 7, 8, 10, 12, 14	
	3221VE06, 3221VE10	
	1471 PH1 x 100, PH2 x 100	
	1472 3 x 75, 4 x 100, 5.5 x 125	
	3771VE08	611607A
	621606A	631808A



389 x 229 x 66 mm IEC 60900:2012, VDE/GS

**45VE01MRV** 1/2" **359€<sup>B</sup>** **16 PZAS**

Contiene		3.22
	4335VE 8, 10, 12, 13, 14, 17, 19, 21, 22, 24	
	4025VE H8, H10	
	4251VE05, 4251VE10	
	4771VE10	4178VE08



**JUEGO DE DESTORNILLADORES AISLADOS**  
IEC 60900:2012, VDE/GS

**30617MR** **41€<sup>B</sup>** **7 PZAS**

Contiene		860
	1471 PH1x100, PH2x100, PH3x150	
	1472 4x100, 5.5x125, 6.5x150, 8x175	



369 x 229 x 66 mm IEC 60900:2012, VDE/GS

**35VE01MRV** 3/8" **279€<sup>B</sup>** **14 PZAS**

Contiene		2.16
	3335VE 10, 11, 12, 13, 14, 17, 19	
	3025VE H5, H6, H8	
	3221VE06, 3221VE10	
	3771VE08	3178VE08

**30607MR** **41€<sup>B</sup>** **7 PZAS**

Contiene		860
	1478 PZ1x100, PZ2x100, PZ3x150	
	1472 4x100, 5.5x125, 6.5x150, 8x175	



294 x 231 x 66 mm IEC 60900:2012, VDE/GS

**25VE01MRV** 1/4" **259€<sup>B</sup>** **18 PZAS**

Contiene		1.30
	2335VE 5, 6, 7, 8, 9, 10, 11, 12, 13, 14	
	2035VE H3, H4, H5, H6	
	2221VE04, 2221VE06	
	2771VE55	2178VE05

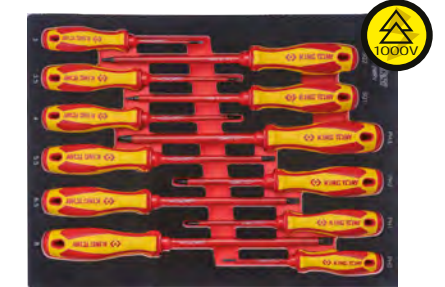

#9 (280 x 375 mm) IEC DIN EN 60900, VDE/GS

**930612MRV** **96€<sup>B</sup>** **12 PZAS**

Contiene		1.30
	1471 PH0x75, PH1x100, PH2x100, PH3x150	
	1472 3x75, 4x100, 3.5x100, 5.5x125, 6.5x150, 8x175	
	1474 1 x 125, 2 x 150	

Oferta válida del 01/01/2025 al 31/12/2025. Precio recomendado de venta al público en euros sin IVA. Fotos no contractuales.



Dentadura gruesa.

Filos con bisel

IEC DIN EN 60900, VDE/GS

**6116A**

**ALICATE UNIVERSAL CON AISLAMIENTO VDE**

**611607A** 22,30€<sup>B</sup>

L mm	Capacidad de corte (Ø mm)	
185	4.0 Alambre blando	290
	3.0 Alambre semiduro	
	2.0 Alambre duro	
	1.6 Alambre	

**611608A** 26€<sup>B</sup>

L mm	Capacidad de corte (Ø mm)	
200	4.0 Alambre blando	386
	3.0 Alambre semiduro	
	2.0 Alambre duro	
	1.6 Alambre	



Filos con bisel

IEC DIN EN 60900, VDE/GS

**621606A**

**ALICATE CORTANTE CON AISLAMIENTO VDE**

**621606A** 22€<sup>B</sup>

L mm	Capacidad de corte (Ø mm)	
167	4.0 Alambre blando	230
	2.8 Alambre semiduro	
	2.0 Alambre duro	
	1.6 Alambre	



Dentadura gruesa.

Corte central.

IEC DIN EN 60900, VDE/GS

**633608A**

**ALICATE CON BOCA SEMI REDONDA ACODADO CON AISLAMIENTO**

**633608A** 26,30€<sup>B</sup>

L mm	Capacidad de corte (Ø mm)	
200	4.0 Alambre blando	250
	3.0 Alambre semiduro	
	2.0 Alambre duro	
	1.6 Alambre	



IEC 60900:2012, VDE/GS

**40603GP**

**JUEGO DE ALICATES AISLADOS**

Contiene 890

611607A	621606A	631808A
---------	---------	---------



Dentadura gruesa.

IEC 60900:2012, VDE/GS

**651610A** 29€<sup>B</sup>

**LLAVES AJUSTABLES AISLADAS**

L mm	A mm	B mm	mm	número de posiciones	
250	55	63	36	7	420

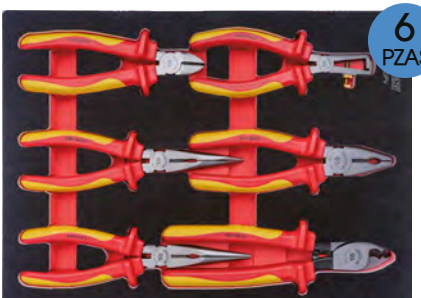

#9 (280 x 375 mm) IEC DIN EN 60900, VDE/GS

**940606GPV**

206€<sup>B</sup>

Contiene 1.88

611607A	631808A	614608A	621606A
633608A	671606A		



#9 (280 x 375 mm) IEC DIN EN 60900, VDE/GS

**940605GPV**

165€<sup>B</sup>

Contiene 1.77

611607A	621606A	631808A	633608A
651610A			



IEC 60900:2012, VDE/GS

**3611VE**

**LLAVES AJUSTABLES AISLADAS**

	mm	L mm		
3611VE06	24	164	167	41€ <sup>B</sup>
3611VE08	28	212	273	52€ <sup>B</sup>
3611VE10	32	260	497	64€ <sup>B</sup>
3611VE12	38	310	679	84€ <sup>B</sup>

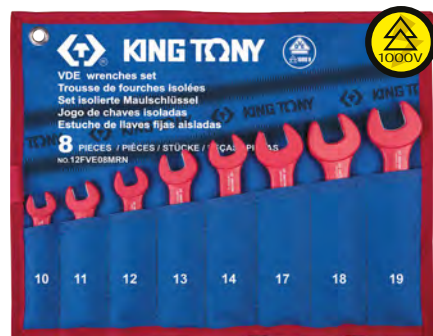

**ESTUCHES DE LLAVES FIJAS AISLADAS**

IEC 60900:2012, VDE/GS

**12FVE08MRN**

163€<sup>B</sup>

Contiene 910

10FOVE	10, 11, 12, 13, 14, 17, 18, 19	8 PZAS
--------	--------------------------------	--------

**12FVE10MRN**

212€<sup>B</sup>

Contiene 1.28

10FOVE	10, 11, 12, 13, 14, 16, 17, 18, 19, 22	10 PZAS
--------	--	---------



#9 (280 x 375 mm) IEC 60900:2012, VDE/GS

**912FVE15MRV**

369€<sup>B</sup>

Contiene 1.96

10FOVE	7, 8, 9, 10, 11, 12, 13, 14, 16, 17, 18, 19, 21, 22, 24	15 PZAS
--------	---	---------



#9 (280 x 375 mm) IEC 60900:2012, VDE/GS

**912FVG15MRV**

479€<sup>B</sup>

Contiene 2.86

10GOVE	7, 8, 9, 10, 11, 12, 13, 14, 16, 17, 18, 19, 21, 22, 24	15 PZAS
--------	---	---------



## COMPOSICIÓN 86 HERRAMIENTAS



934086MRVD

1/4" + 3/8"

1469€<sup>D</sup>

10.34

Contiene

	2335VE	5, 6, 7, 8, 9, 10, 11, 12, 13, 14
	2035VE	H3, H4, H5, H6
	2221VE04, 2221VE06	
	2771VE55	2178VE05
	3335VE	10, 11, 12, 13, 14, 15, 16, 17, 18, 19
	3235VE	8, 10, 12, 14
	3025VE	H8, H10
	3221VE06, 3221VE10	
	3771VE08	3178VE08

	1471	PH0 x 75, PH1 x 100, PH2 x 100, PH3 x 150
	1472	3 x 75, 4 x 100, 3.5 x 100, 5.5 x 125, 6.5 x 150, 8 x 175
	1474	RB1 x 125, RB2 x 150
	10F0VE	7, 8, 9, 10, 11, 12, 13, 14, 16, 17, 18, 19, 21, 22, 24
	10G0VE	7, 8, 9, 10, 11, 12, 13, 14, 16, 17, 18, 19, 21, 22, 24

	611607A		614608A
	621606A		631808A
	633608A		671606A



## OPCIONAL

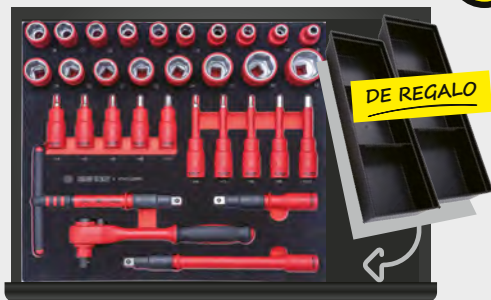

945VE02MRVP 1/2"

579€<sup>B</sup>

Contiene

	4335VE	8, 10, 11, 12, 13, 14, 15, 16, 17, 18, 19, 20, 21, 22, 24, 27, 30, 32
	4025VE	H4, H5, H6, H8, H10
	4035VE	H4, H5, H6, H8, H10
	4251VE05, 4251VE10	
	4771VE10	4178VE08 84700011BS2



9052001MRV

35 PZAS

499€<sup>D</sup>

## CAJA DE HERRAMIENTAS PARA ELECTRICISTAS

Contiene

8.69

	1471	PH0 x 75, PH1 x 100, PH2 x 100			
	1472	3 x 75, 4 x 100, 5.5 x 125, 6.5 x 150			
	1120MR	H1.5, H2, H2.5, H3, H4, H5, H6, H8, H10			
	671606A		621606A		633608A
	631808A		614608A		
	3611VE08		361110R		
	651110		631108		9CJ1120
	7909505M				
	6CB21		6CB02		67B355
	67A107				
	6AG1120		7622308		7621010
	782150OS		874052		

## HERRAMIENTAS CON AISLAMIENTO 1000 V



11 mm

1451VE11



59€<sup>D</sup>

NF EN 60900 / CEI 60900

### DESTORNILLADOR AISLADO 1000 V PARA TORNILLOS TRIANGULARES

Permite trabajar en los tornillos triangulares de las cajas de conexiones. Hoja de acero tratado. Cuerpo de acetato. Cuerpo aislado 1000 V, excepto la cavidad para facilitar la penetración en los ejes de los tornillos. Impresión bruñida.



3432VE20M



3/8"

629€<sup>D</sup>

NF EN 60900 / CEI 60900 / NF EN ISO 6789-1-2017

### LLAVE DINAMOMÉTRICA AISLADA 1000 V

Tipo II- CLASE A

Precisión de par garantizado al ±3% (sentido horario /CW). Accionamiento en sentido horario (CW).



SUMISTRADO CON CERTIFICADO DE CALIBRACIÓN

PRECISIÓN +/- 3%

PUSH BUTTON



530

Capacidad de par

Cuadrado conductor	Nm	Grad.	lbf.in	Número de dientes	Largo total mm	
3432VE20M	3/8"	4-20 Nm	1 Nm	40-180 lbf.in	72	230

180

Oferta válida del 01/01/2025 al 31/12/2025. Precio recomendado de venta al público en euros sin IVA. Fotos no contractuales.



# KING TONY



# PENTA

ELECTRICAL SAFETY PRODUCTS



# New

1 AÑO DE GARANTÍA

## HERRAMIENTAS AISLADAS 1000V



NF EN 60900 / IEC 60900 / FT BT 405

**IS79** 45€ <sup>D</sup>

### CUCHILLO AISLADO 1000V CON HOJA CORTA

88

Recomendado para pelar cables de sección pequeña.  
Hoja de acero inoxidable endurecido.  
Acabado con pulido electrolítico para garantizar un filo duradero.  
Empuñadura lastrada para un buen equilibrio y para evitar que la herramienta caiga sobre la hoja. La parte posterior de la hoja está cubierta con un aislante para evitar cortocircuitos.



NF EN 60900 / IEC 60900 / FT BT 405

**IS77** 53€ <sup>D</sup>

### CUCHILLO AISLADO DE 1000 V CON HOJA LARGA Y GRUESA

100

Recomendado para pelar cables.  
Red aérea o subterránea, instalación interior.  
Hoja de acero inoxidable, aislamiento moldeado por inyección.  
Acabado con pulido electrolítico para garantizar un filo duradero.  
Empuñadura lastrada para un buen equilibrio y para evitar que la herramienta caiga sobre la hoja. La parte posterior de la hoja está cubierta con un aislante para evitar cortocircuitos.

Con protector de mano para evitar que la mano se deslice hacia la hoja.

El mango está dentado para un agarre óptimo.

Mango grande para un mejor agarre y mayor comodidad.

NF EN 60900 / IEC 60900

**IS80C** 171€ <sup>D</sup>

**CUCHILLO AISLANTE CON HOJA DE CERÁMICA**

Cuchillo para pelar fundas de plástico de cables eléctricos.  
Esta herramienta no corta tiras de metal. Cuchillo aislante con hoja de corte de cerámica sin piezas ni insertos metálicos, lo que lo convierte en un producto seguro.  
Hoja de cerámica, por lo que a prueba de óxido, sin desgaste, sin afilar.

Tapa protectora extraíble del mango mediante giro, que protege la hoja cuando está guardada y protege al usuario de cortes accidentales.

70



Largo Cuchilla 35 mm



NF EN 60900 / IEC 60900

**MS2E** 114€ <sup>D</sup>

### TIJERAS DE ELECTRICISTA TOTALMENTE AISLADAS

76

Picos largos y puntiagudos de acero inoxidable con cortaalambres.  
Modelo para diestros y zurdos.  
Anillos abiertos para trabajar con guantes.  
Funda no suministrada.

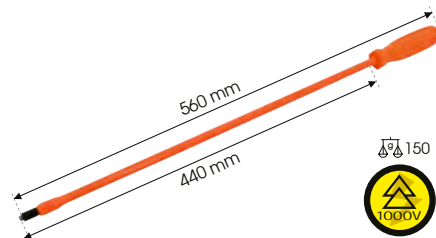

NF EN 60900 / IEC 60900

**TFA** 136€ <sup>D</sup>

### MANGO AISLADO DE 1000 V, CON VARILLA FLEXIBLE Y PUNTA MAGNÉTICA

Diseñado para acceder y recuperar pequeños componentes metálicos (como tornillos, tuercas, arandelas, etc.) de zonas de difícil acceso.  
Fuerza máxima de carga/elevación: 120 g.



90

**TC120** 17€ <sup>D</sup>

### ESQUINA AISLANTE

Los 2 lados de la cuña están cortados con 4 ranuras de media caña para separar los conductores de los cables trenzados.  
Material: poliamida 6.

# EQUIPAMIENTO DE SEGURIDAD

**TAG780VIFE** 217€

**DETECTOR DE TENSIÓN - BAJA TENSIÓN**

Como parte del procedimiento de Consignación, el TAG780V puede utilizarse para llevar a cabo la Comprobación de Ausencia de Tensión. Otras funciones completan este detector, convirtiéndolo en una herramienta muy operativa para el operador (continuidad, búsqueda de fase, nivel de tensión, etc.). Alarma acústica de tensión diferenciada según el nivel de tensión (sonido discontinuo hasta 230 V y sonido continuo por encima de 400 V). Indicación de polaridad (-/+). Autodiagnóstico incorporado. Búsqueda de fase en modo unipolar (uso indiferente de cualquiera de los dos puntos de contacto). Pantalla ultrabrillante de nueva generación. Cordon de silicona con doble aislamiento: robusto y ultraflexible (sin efecto memoria). Retracción del manguito mediante un gatillo situado en la parte posterior del dispositivo: solución exclusiva que garantiza la retirada controlada del manguito y la seguridad visual del contacto.

**INFORMACIONES TÉCNICAS**

Test de tensión DC	12, 24, 50, 127, 230, 400, 690, 1000 V
Test de tensión AC	12, 24, 50, 127, 230, 400, 690, 1000 V
Rango de frecuencia	15 - 60 Hz
Test de continuidad	<80 Ω
Autorización	IEC 61243-3, CAT.IV 1 000 V, IP2X, IP65

Funda de transporte 288

IP65

AAA 1.5V x 2 incluida

EN 60903 / IEC 60903

**TP12EC** 125€

**PÉRTIGA DE RESCATE AISLADA**

Se utiliza para rescatar a una víctima de accidente (electrocución, deslumbramiento, etc.) cuando se trabaja en subestaciones o celdas de 1ª, 2ª y 3ª categoría. Permite tirar de la persona herida hacia una zona protegida colgándola por la cintura. Tensión de prueba sobre 300 mm: 100 kV. Gancho de tubo de acero de 180 x 150 mm. Poste con cuerpo de 45 kV con gancho y sin guarda de protección. Longitud total sin gancho (m): 1.47. Entregado con 2 soportes y un gancho.

**S115RB8** 178€

**CADENA DE BALIZAMIENTO EN POLIETILENO DE ALTA DENSIDAD**

Resistente. Tratamiento anti-UV. Se suministra en una bolsa.

Ø Cadena	8 mm
Longitud de la cadena	25 mm

**S115SPPR** 241€

**POSTE EN BASE PARA CADENA DE BALIZA DE POLIETILENO**

Ideal para la delimitación en exteriores. Sistema de bloqueo del poste en ambas posiciones. El sistema de plegado ahorra hasta un 70% de espacio de almacenamiento. Incluye 1 base lastrada y 1 poste listo para usar.

Peso de la base 4 kg  
Dimensiones de la base 280 x 280 x 70 mm

**TS20**

**TS21**

**BOLSA AISLANTE PARA CONECTORES**

Se utiliza en la red aérea y en instalaciones interiores. Colocada en un conector unido al extremo libre de un conductor, la bolsa aislante se utiliza para evitar el contacto involuntario entre el conector y una parte conductora a un potencial diferente del suyo. Trabaje al contacto tirando del anillo de sujeción de la bolsa o bajando y deslizando la bolsa a lo largo del conector hasta que se suelte. Polivinilo transúcido. Cierre de velcro.

	Largo (mm)	Anchura (mm)	Precio
TS20	210	130	28€
TS21	305	225	39€

**TN17066M** 42€

**CAPA AISLANTE CON VELCRO**

Aislamiento cubriendo las partes conductoras de la red de baja tensión. Se pueden unir varias capas.

**TP60P** 7€

**ABRAZADERA DE RESORTE DE PLÁSTICO 1000 V**

Para fijar cubiertas protectoras temporales, como manteles. Capacidad de apriete: 25 mm. Resistente a la intemperie. Para redes aéreas y subterráneas e instalaciones interiores.

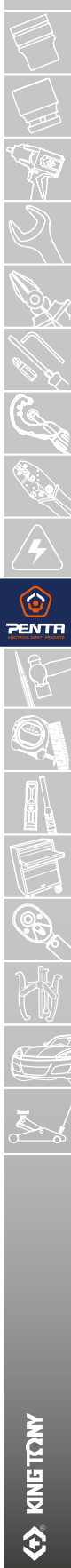



**TC**

**CAPUCHÓN AISLANTE DE BAJA TENSIÓN PARA EXTREMOS DE CONDUCTORES**

Se utiliza para instalaciones aéreas, subterráneas e interiores. Diseñado para aislar el extremo pelado de un conductor aislado (esta longitud debe ser como máximo igual a la longitud del capuchón menos 10 mm) durante la duración del trabajo. Abertura con un corte en forma de cruz para insertar un conductor. Tapón cilíndrico semirrígido de material aislante flexible. Se venden individualmente o en múltiplos de 4 por cada conductor de baja tensión.

	Largo (mm)	Ø exterior (mm)	Capacidad (mm <sup>2</sup> )	Ø max (mm)	
TC25	60	10	3 - 10	6.5	3,60€ D
TC30	100	15	6 - 35	11	5€ D
TC35	120	20	20 - 70	15	6€ D
TC40	120	25	30 - 100	20	6€ D
TC41	120	35	240	30	17€ D

**EQUIPOS DE PROTECCIÓN INDIVIDUAL**



EN 397, EN 50365 - GS-ET-29 : APC1  
Normas de protección ocular:  
EN 166, EN 167, EN 168, EN 170

**TC42ESBBSC 167€ D**

**CASCO DE PROTECCIÓN CON PANTALLA FACIAL INTEGRADA PARA ELECTRICISTAS**

Casco con pantalla integrada para proteger contra los arcos de cortocircuito. Casco para electricistas (operaciones, industria, sector terciario, etc.) Propiedades antivaho en el interior de la pantalla. Protección antirayaduras en la parte exterior de la pantalla. Permite llevar gafas con lentes correctoras. Sistema de ajuste de la banda de la cabeza para su uso con guantes aislantes. Ranura universal para accesorios. Doble tapa para una protección óptima de la pantalla, prolongando su vida útil y proporcionando una protección superior contra los riesgos eléctricos y de arco eléctrico. Alto nivel de VLT (Transmitancia de Luz Visible) para mejorar la visibilidad.

Material de la carcasa : ABS.  
Ajuste del casco: cremallera.  
Circunferencia de la cabeza (cm): 53-62.  
Banda de confort: espuma.  
Puntos de fijación: 6 puntos.  
Puntos de anclaje del protector de barbilla: 4 puntos.  
Vida útil desde el primer uso: 36 meses.

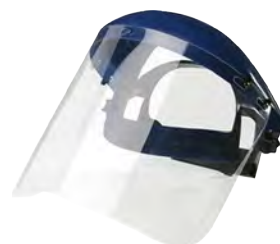

Normas de protección ocular:  
EN 166, EN 167, EN 168, EN 170

**E24 105€ D**

**PANTALLA FACIAL CON BANDA PARA LA CABEZA Y PROTECTOR DE FRENTE PARA ELECTRICISTAS**

Protección de los ojos, la cara y la parte superior de la cabeza contra los arcos de cortocircuito. Para trabajos en o cerca de instalaciones de baja tensión. El juego incluye 1 soporte de pantalla y 1 pantalla facial. Soporte de pantalla compuesto por una carcasa frontal de polipropileno de color azul, una cinta para la cabeza ajustable mediante un pomo con un sistema de cremallera (de 53 a 61 cm) y una banda de confort de espuma antisudor. Pantalla facial abatible, apretada por 2 pomos laterales.

Marcado :  
- 2C = 100% de filtración UV  
- 1.2 = lente transparente que deja pasar el 91.2% de la luz visible  
- 1 = calidad óptica / Clase 1, sin deformación cuando se lleva de forma continuada  
- AT = resistencia a los impactos a alta velocidad: 190 m/seg entre -5°C y +55°C  
- 8 = protección contra los arcos de cortocircuito  
- 9 = resistencia al metal fundido y a las partículas calientes.

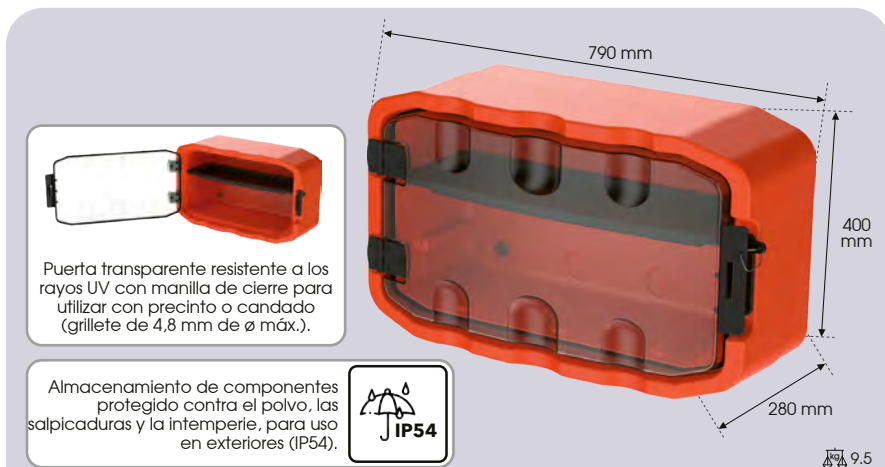

Puerta transparente resistente a los rayos UV con manilla de cierre para utilizar con precinto o candado (grillete de 4,8 mm de Ø máx.).

Almacenamiento de componentes protegido contra el polvo, las salpicaduras y la intemperie, para uso en exteriores (IP54).



9.5

**PS2PM**

556€ D

**MALETÍN IMPERMEABLE PARA GUARDAR EL EQUIPO DE RESCATE**

Para guardar el equipo de rescate utilizado para rescatar rápidamente a una víctima en caso de incidente en una instalación eléctrica o cerca de ella.

Para uso interior o exterior.

Inserto de montaje de equipos optimizado para un almacenamiento eficaz y una intervención rápida.

Equipos de rescate para una intervención rápida en caso de accidente eléctrico.

Maletín con cerradura para evitar el robo de equipos.

Kit de montaje en pared incluido.

Módulo vacío, entregado sin componentes, placa ni bandeja.



**CSKD1P438 53€ D**    **CSKD1P476 54€ D**

**CANDADO CON ARCO INTERCAMBIABLE Y LLAVE DE ALTA SEGURIDAD**

Para el procedimiento de bloqueo, siga los 5 pasos de bloqueo-etiquetado.

Con un sistema de llave de combinación aleatoria: cada candado tiene su propia llave única, lo que permite abrir sólo un candado y ningún otro.

Candado con cuerpo no metálico.

Mangos compuestos.

El sistema de grilletes intercambiables permite adaptar rápidamente el grillete a la instalación que se desea bloquear, sin necesidad de cambiar el candado.

Llave que combina perforaciones y ranuras para un alto nivel de seguridad.

Más de 1.000.000 variaciones posibles de las teclas.

Sistema de llave bloqueada: la llave no puede retirarse hasta que el candado esté cerrado.

Cilindro con retorno automático de llave.

Incluye:

1 grillete ajustado, 1 llave variada, 1 juego de etiquetas adhesivas de cierre en 6 idiomas (resistentes a la abrasión y a los rayos UV), 1 juego de instrucciones.



EN 60903 / IEC 60903

**EOS9030**

228€<sup>D</sup>

**COMPROBADOR NEUMÁTICO DE GANTES AISLANTES FLEX&GRIP Y ELECTROVOLT GLE**



Este inflador neumático se utiliza para comprobar la integridad de los guantes aislantes antes de su uso. Inspección visual por inflado, de acuerdo con las recomendaciones de la norma 60903 (EN e IEC).  
Cuerpo de plástico moldeado que comprende :  
- un extremo cónico con dos ranuras, diseñado para recibir el guante que se va a probar  
- un pistón central situado en la base del dispositivo  
- una válvula flexible, situada en el fondo del recipiente en la parte superior  
- dos anillos elásticos para sujetar el guante durante el inflado.

**EOSE9030**

228€<sup>D</sup>

**COMPROBADOR NEUMÁTICO GANTES AISLANTES TOUCH-E**



Clase 0  
EN 60903 / IEC 60903

**GICNBT**

**GUANTES AISLANTES COMPUESTOS - FLEX&GRIP**

Guantes compuestos aislantes para trabajar con seguridad sin sobreguantes de cuero.  
Para operaciones de mantenimiento con alto riesgo mecánico. Propiedades especiales (categoría) RC, con protección mecánica. Producto compuesto por mezclas de polímeros de alto rendimiento, que combinan resistencia mecánica, química y dieléctrica. Revestimiento exterior especialmente formulado para un agarre excepcional, incluso en condiciones húmedas o grasientas. Par de manoplas de algodón bajo los guantes, suministradas con cada par de guantes aislantes, para absorber la transpiración y mejorar la higiene, preservando al mismo tiempo la destreza.

	Largo (mm)	Talla	Grosor (mm)	
GICNBT09	410	9	< 2.9	103€ <sup>D</sup>
GICNBT10	410	10	< 2.9	103€ <sup>D</sup>



Categorías : A, Z, C  
Categorías CE : Categoría 3  
EN 388 : 1121X - IEC 61482 - ASTM F2675

**JFO360**

**GUANTES AISLANTES DE CAUCHO NATURAL - TOUCH-E**

Guantes aislantes de caucho natural naranja. El diseño fino y la zona de agarre facilitan su manejo. Excelente destreza. Táctil. Nivel de protección del brazo: longitud: antebrazo (< 400 mm). Material de revestimiento: látex. Nivel de recubrimiento: totalmente recubierto. Número de capas: una capa. Característica del puño del guante aislante: sin puentear. Tensión máxima de funcionamiento: alterna (V AC).

	Largo (mm)	Talla	
JFO36009	360	9	81€ <sup>D</sup>
JFO36010	360	10	81€ <sup>D</sup>



EN 388 : 2122X



**RGXSG**

**SOBREGUANTE DE CUERO PARA PROTECCIÓN MECÁNICA DE GANTES DE LÁTEX**

Guantes de piel con puño de serraje vacuno. Se recomienda llevar protectores de cuero sobre los guantes de goma aislantes para proporcionar protección mecánica (se aplican las normativas locales, las prácticas de trabajo y el análisis de riesgos). Diseñado específicamente para adaptarse a los guantes Electrovolt y garantizar un buen nivel de destreza. Manguito con abrazadera ajustable. Palma y dorso de piel de vacuno, con acabado de piel plena flor hidrófuga. Piel con tratamiento hidrófugo.

	Largo (mm)	Talla	
RGXSGB	100	B	39€ <sup>D</sup>
RGXSGB	100	C	39€ <sup>D</sup>



Clase 00  
Categorías : A, Z, C  
EN 60903 / IEC 60903

**GLE360**

**GUANTES AISLANTES DE LÁTEX ELECTROVOLT GLE**

Aislamiento de las manos según clase y tensión nominal de red. Se utiliza con un sobreguante de cuero para protección mecánica. Guantes de látex natural, beige, aislantes, bordes cortados. La forma ergonómica del guante y su interior ligeramente empolvado facilitan su colocación y extracción. La estructura a base de látex natural proporciona altas propiedades dieléctricas; su grosor protege a la vez que garantiza una excelente destreza.

	Grosor (mm)	Talla	
GLE36009	< 1.6 mm	9	54€ <sup>D</sup>
GLE36010	< 1.6 mm	10	54€ <sup>D</sup>



150

**RGXSAC**

38€<sup>D</sup>

**FUNDA DE TRANSPORTE PARA GANTES AISLANTES**

Funda de transporte para guantes aislantes cortos, que proporciona protección mecánica y protección contra los rayos UV. Compartimento con solapa y cierre a presión, que incluye un bolsillo plano transparente para guardar las instrucciones de uso y un bolsillo lateral abierto para un frasco de polvos de talco. Sin bordes afilados o puntiagudos en contacto con los guantes. Tejido de poliéster con revestimiento de PVC impermeable.



# MARTILLOS



## 7821OS

### MARTILLOS DE MECÁNICO

Mango Hickory. Cabeza de acero.  
DIN 1041.

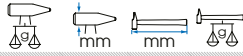

Modelo	300	22.5	300	373	Precio
782130OS	300	22.5	300	373	11€ <sup>B</sup>
782150OS	500	27	320	615	16€ <sup>B</sup>
782180OS	800	33	350	932	21€ <sup>B</sup>



## 7823OS

### MARTILLOS DE MECÁNICO

Mango Hickory. Cabeza de acero.  
DIN 1193.

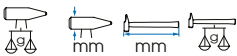

Modelo	1000	36	360	1196	Precio
782310OS	1000	36	360	1196	23,20€ <sup>B</sup>
782315OS	1500	41	380	1661	31€ <sup>B</sup>
782320OS	2000	46	400	2200	40€ <sup>B</sup>



## 7820

### MARTILLOS DE MECÁNICO

Mango tres materiales. Cabeza de acero.

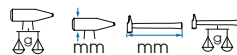

Modelo	300	22.5	300	471	Precio
782023	300	22.5	300	471	24€ <sup>B</sup>
782027	500	27	320	702	30€ <sup>B</sup>
782036	1000	36	360	1353	42€ <sup>B</sup>
782042	1500	41.5	360	1853	47€ <sup>B</sup>



## 7861

### MARTILLOS DE CARPINTERO

Mango Hickory. Cabeza de acero.  
DIN 1041.



Modelo	450	30	335	740	Precio
786116	450	30	335	740	14€ <sup>B</sup>
786120	565	31	340	830	15,50€ <sup>B</sup>
786124	680	32	380	920	19,60€ <sup>B</sup>



## 7822OS

### MARTILLO DE AJUSTADOR

Mango de fresno perfilado. Cabeza de acero.  
DIN 1193.

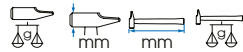

Modelo	400	27	310	438	Precio
782225OS	400	27	310	438	11,80€ <sup>B</sup>
782230OS	500	29	320	554	13,80€ <sup>B</sup>
782235OS	800	36	350	938	18,90€ <sup>B</sup>
782240OS	1000	38	360	1141	21€ <sup>B</sup>
782245OS	1500	45	380	1671	30€ <sup>B</sup>
782250OS	2000	50	400	2150	35€ <sup>B</sup>



## 7862

### MARTILLOS DE AJUSTADOR

Mango tres materiales. Cabeza de acero.

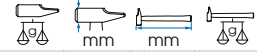

Modelo	500	29	325	697	Precio
786229	500	29	325	697	29,30€ <sup>B</sup>
786238	1000	38	360	1364	41€ <sup>B</sup>
786244	1500	44	365	1778	48€ <sup>B</sup>
786250	2000	50	405	2460	63€ <sup>B</sup>



## 7811OS

### MARTILLOS DE MECÁNICO CABEZA ESFÉRICA

Mango Hickory. Cabeza de acero.  
C45, BA876.

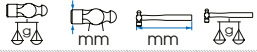

Modelo	230	23	300	318	Precio
781108OS	230	23	300	318	12€ <sup>B</sup>
781112OS	340	27	325	428	14€ <sup>B</sup>
781116OS	440	28	350	562	15,50€ <sup>B</sup>
781124OS	540	31	365	656	18,80€ <sup>B</sup>
781132OS	700	33	375	803	22€ <sup>B</sup>
781140OS	910	40	405	1100	26€ <sup>B</sup>



## 787125

10€<sup>B</sup>

### MARTILLO SOLDADOR PARA PICAR

Acabado Epoxy. Boca horizontal.  
Mango de nylon.

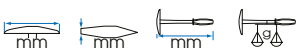

Modelo	120	18	275	255
787125	120	18	275	255



## 7833OS

### MAZA CON ÁNGULOS ABATIDOS

Mango de fresno perfilado. Cabeza de acero.  
DIN 1193.

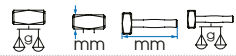

Modelo	1000	40	260	1081	Precio
783310OS	1000	40	260	1081	17,10€ <sup>B</sup>
783312OS	1250	43	260	1287	20€ <sup>B</sup>
783315OS	1500	45	280	1650	25€ <sup>B</sup>
783320OS	2000	50	300	2050	31€ <sup>B</sup>



## 7843

### MAZA CON ÁNGULOS ABATIDOS

Mango tres materiales. Cabeza de acero.

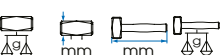

Modelo	1000	39	260	1230	Precio
784310	1000	39	260	1230	35€ <sup>B</sup>
784315	1500	45	280	1733	44€ <sup>B</sup>



Lleve equipo de seguridad.



7855

Cobre

**MAZA CON ÁNGULOS ABATIDOS**

Mango Hickory. Cabeza de varilla de cobre estirado con doble endurecimiento. Evita que salten chispas.



785510	1000	33	350	1190	89€ <sup>B</sup>
785525	250	20	280	312	30€ <sup>B</sup>
785550	500	26	300	600	50€ <sup>B</sup>
785575	750	28	320	860	68€ <sup>B</sup>



7842\_PIH

**MACETAS CON PUNTAS INTERCAMBIABLES**

Mango Hickory. Cabeza de acero. Puntas de poliuretano.

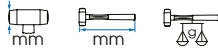

784222PIH	22	280	180	16,60€ <sup>B</sup>
784227PIH	27	300	294	19€ <sup>B</sup>
784232PIH	32	300	378	23€ <sup>B</sup>
784240PIH	40	320	624	32€ <sup>B</sup>
784250PIH	50	320	910	41€ <sup>B</sup>



7851

**MACETA SIN REBOTE**

Mango polipropileno. Maceta monobloc con micro-bola de acero. Reduce las vibraciones.

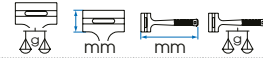

785108	227	43	272	585	13,30€ <sup>B</sup>
785116	454	46	304	849	16,30€ <sup>B</sup>
785124	680	49	322	884	18,60€ <sup>B</sup>
785132	907	55	342	1090	25,40€ <sup>B</sup>
785140	1134	58	342	1218	28,70€ <sup>B</sup>
785148	1361	61	355	1511	32,30€ <sup>B</sup>
785164	1814	67	368	1874	40,30€ <sup>B</sup>



7848

**MACETA DE GOMA**

Ideal para la colocación de suelos de basalto, neumáticos y otros materiales que no deben ser dañados.

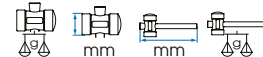

784860	523	64	330	628	13€ <sup>B</sup>
784880	821	79	350	979	17€ <sup>B</sup>



7842\_PAH

Aluminio

**MACETAS CON PUNTAS INTERCAMBIABLES**

Mango Hickory. Cabeza de aluminio. Puntas de poliuretano.



784222PAH	22	280	124	13€ <sup>B</sup>
784227PAH	27	300	187	19,60€ <sup>B</sup>
784232PAH	32	300	230	24€ <sup>B</sup>
784240PAH	40	320	375	35€ <sup>B</sup>
784250PAH	50	320	504	48€ <sup>B</sup>



7842\_PIT

**MACETAS CON PUNTAS INTERCAMBIABLES**

Mango tres materiales. Cabeza de acero. Puntas de poliuretano.

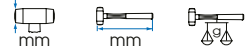

784227PIT	27	300	356	30€ <sup>B</sup>
784232PIT	32	300	450	35€ <sup>B</sup>
784240PIT	40	320	719	50€ <sup>B</sup>
784250PIT	50	320	975	61€ <sup>B</sup>



7842\_PAT

Aluminio

**MACETAS CON PUNTAS INTERCAMBIABLES**

Mango tres materiales. Cabeza de aluminio. Puntas de poliuretano.



784227PAT	27	300	259	31€ <sup>B</sup>
784232PAT	32	300	298	38€ <sup>B</sup>
784240PAT	40	320	459	53€ <sup>B</sup>
784250PAT	50	320	584	70€ <sup>B</sup>



783450

65€<sup>B</sup>

**MAZO**

Mango de fibra de vidrio.

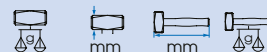

783450	5000	68	908	5850
--------	------	----	-----	------



7852

**MARTILLO SIN REBOTE**

Cabeza de goma. Mango de fibra de vidrio.

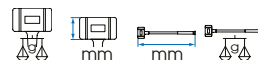

785223	1650	69.5	500	2000	87€ <sup>B</sup>
785255	4500	104	910	5500	167€ <sup>B</sup>

# HERRAMIENTAS DE GOLPE



Lleve equipo de seguridad.



**7622610GR** 20€<sup>B</sup>

**BURIL EXTRA PLANO ENFUNDADO**  
Reduce las vibraciones. Guarda de protección para la mano. Agarre cómodo.

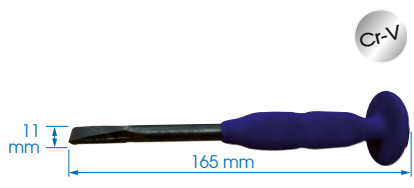

**7651007G** 11€<sup>B</sup>

**ESCOPLO ENFUNDADO**  
Reduce las vibraciones. Guarda de protección para la mano. Agarre cómodo.



**1005APR** 20€<sup>B</sup>

Contiene	1005APR
	7610405
	7621505
	7630305
	7640406
	7651005



**76610**

**BOTADORES ENFUNDADOS DE LATÓN**

De latón para no desgastar las piezas que hay que trabajar. Empuñadura extraíble: reduce las vibraciones y permite un mejor agarre.

	L mm	Ø mm	100g	Precio
<b>7661010</b>	250	10	231	17,70€ <sup>B</sup>
<b>7661210</b>	250	12	382	21€ <sup>B</sup>
<b>7661510</b>	250	15	478	31€ <sup>B</sup>
<b>7662010</b>	250	20	637	43€ <sup>B</sup>



**1014GPL** 81€<sup>B</sup>

Contiene	1014GPL
	76612 Ø10, Ø12, Ø14, Ø16



**1014GPRB** 112€<sup>B</sup>

Contiene	1014GPRB
	76610 Ø10, Ø12, Ø15, Ø20



**1025PRN** 33€<sup>B</sup>

Contiene	1025PRN
	762 13 x 100, 15 x 125, 17 x 150, 20 x 175, 23 x 200



**New**

## BOTADORES

Para impactos precisos, el mango tiene una muesca rodeada de un material antideslizante y amortiguador que sujeta la herramienta firmemente a la punta de los dedos, lo que la hace más segura y cómoda de usar. Acero al cromo vanadio (Cr-V). Acabado pulido.

La onda de choque que asciende por la hoja se atenúa mediante una tira de material amortiguador situada en el interior del mango.



**76629P** 129€<sup>B</sup>

**SET EN CAJA DE CARTÓN DE 5 BOTADORES CON MANGO ERGONÓMICO ANTIVIBRACIONES**

Contiene	76629P
	7661 10, 12, 14, 16, 18 x 290 mm



**76677P** 188€<sup>B</sup>

**SET EN CAJA DE CARTÓN DE 5 BOTADORES CON MANGO ERGONÓMICO ANTIVIBRACIONES**

Contiene	76677P
	7661 10, 12, 14, 16, 18 x 290 mm
	762BI 15 x 185 mm, 25 x 225 mm







**1006PRN** 28€<sup>B</sup>

Contiene 570

764 Ø 2 x 30, Ø 3 x 40, Ø 4 x 50, Ø 5 x 50, Ø 6 x 50, Ø 8 x 50

**6**  
PZAS

**1009PRN** 53€<sup>B</sup>

Contiene 1.6

764 Ø 2 x 30, Ø 3 x 40, Ø 4 x 50, Ø 5 x 50, Ø 6 x 50, Ø 8 x 50, Ø 10 x 65, Ø 12 x 70, Ø 14 x 75

**9**  
PZAS



**1006GPN** 42€<sup>B</sup>

Contiene 800

764G Ø 2 x 140, Ø 3 x 150, Ø 4 x 180, Ø 5 x 200, Ø 6 x 210, Ø 8 x 220

**6**  
PZAS

**1009GPN** 81€<sup>B</sup>

Contiene 1.9

764G Ø 2 x 140, Ø 3 x 150, Ø 4 x 180, Ø 5 x 200, Ø 6 x 210, Ø 8 x 220, Ø 10 x 230, Ø 12 x 250, Ø 14 x 290

**9**  
PZAS



**7**  
PZAS

**76625C** 55€<sup>B</sup>

**COFRE DE PUNTAS SIN REBOTE**

Cuerpo con microbolas para suavizar los choques y reducir las vibraciones. Protege las piezas durante su posicionamiento o su extracción.

Contiene 870

160 mm Cr-V Ø 25 mm latón

Ø 25 mm poliamida Ø 25 mm aluminio



**11409SQ**

**JUEGOS DE 9 NÚMEROS DE GOLPE**

Cifra de 0 a 8.

	L mm	mm	 mm	
11409SQ05	61	8x8	5	13€ <sup>B</sup>
11409SQ08	71	12.7x12.7	8	20,60€ <sup>B</sup>
11509SQ05	61	11x11	5	18,30€ <sup>B</sup>



**11427SQ**

**JUEGOS DE 27 LETRAS DE GOLPE**

Alfabeto de A a Z + carácter "&".

	L mm	mm	 mm	
11427SQ05	61	8x8	5	26,60€ <sup>B</sup>
11427SQ08	71	12.7x12.7	8	61€ <sup>B</sup>
11527SQ05	71	11x11	5	55€ <sup>B</sup>



# HERRAMIENTAS PARA TALLER



28  
PZAS



11328SQ

119€<sup>B</sup>

## JUEGO DE MACHOS DE ROSCAR Y BROCAS

Acero HSS

3 Machos de roscar/Talla (desbastador, intermediario, rematador)

Contiene

2.5, 3.3, 4.2, 5, 6.8, 8.5, 10.2

M3, M4, M5, M6, M8, M10, M12



54  
PZAS



13954MQ

799€<sup>B</sup>

## CAJA DE MACHOS DE ROSCAR E HILERAS

Acero HSS. 3 Machos de roscar/Talla (desbastador, intermediario, rematador).

Contiene

	M3x2.5 M4x3.3 M5x4.2 M6x5.0 M8x6.8 M10x8.5	M12x10.2 M14x12.0 M16x14.0 M18x15.5 M20x17.5
--	---	--

20x5, 20x7, 25x9, 30x11, 38x14, 45x18

1xN°1, 1xN°3



39  
PZAS



12939MQ1

119€<sup>B</sup>

12939SQ1

12939SQ1

126€<sup>B</sup>

## COFRES DE MACHOS DE ROSCAR E HILERAS

Acero con alta cantidad de carbono SK5

Contiene

	M3x0.5 M3x0.6 M4x0.7 M4x0.75 M5x0.8 M5x0.9 M6x0.75 M6x1.0 M7x0.75	M7x1.0 M8x1.0 M8x1.25 M10x1.25 M10x1.5 M12x1.5 M12x1.75 1/8NPT27		25 mm (1")
	0.5, 0.6, 0.7, 0.75, 0.8, 0.9, 1.0, 1.25, 1.5, 1.75, 27, 28			M3~M12 (1/8"~1/2")
	4NS36 6NC32 8NC32 10NC24 10NF32 12NC24 1/4NC20 1/4NF28 5/16NC18	5/16NF24 3/8NC16 3/8NF24 7/16NC14 7/16NF20 1/2NC13 1/2NF20 1/8NPT27		M3~M6 (1/8"~1/4")
	12, 13, 14, 16, 18, 20, 24, 27, 28, 32, 36, 40			



New

4  
PZAS



39104M

87€<sup>B</sup>

## ESTUCHE PARA HERRAMIENTAS DE TRINQUETE

mm	Capacidad Tornillo	Ø mm
----	--------------------	------

39122008MD	1/4"	M3~M8	2.5 ~ 5
39123010MD	3/8"	M1~M10	2 ~ 6
39124012MD	1/2"	M10~M20	6 ~ 12
39124016MD	1/2"	M20~M27	12 ~ 17



3912

## PORTA HERRAMIENTA PARA CARRACA

- Usar con una carraca o con una llave en T
- Para macho de roscar

KT NO.



Capacidad Tornillo

Ø mm



52

20,5€<sup>B</sup>

21€<sup>B</sup>

22€<sup>B</sup>

32€<sup>B</sup>

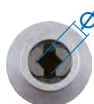

10 AÑOS DE GARANTÍA

Mordazas de acero intercambiables.

Mordazas para tubos.

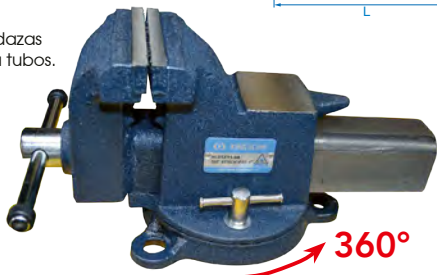

360°

Tornillo de banco de acero forjado.

TORNILLOS DE BANCO CON BASE GIRATORIA

9TZ11

mm W mm H mm L mm kg

9TZ1104	146	104	57	310	7.50	132€ <sup>D</sup>
9TZ1105	166	130	67	365	11.0	159€ <sup>D</sup>
9TZ1106	200	155	76	422	14.5	202€ <sup>D</sup>
9TZ1108	225	200	89	492	18.0	257€ <sup>D</sup>
9TZ1110	250	250	102	572	25.6	405€ <sup>D</sup>



75RF09M

43€<sup>B</sup>

PEINE DE FILETEADO ISO

- Para restaurar roscas internas y externas defectuosas.
- Adecuado para roscas a derechas y a izquierdas.
- Adecuado para roscas métricas: 0,80 - 1,00 - 1,25 - 1,50 - 1,75 - 2,00 - 2,50 - 3,00.



5 PZAS

250 mm

1015GQ

56€<sup>B</sup>

JUEGO DE LIMAS SEMI-SUAVE

Contiene

1.2

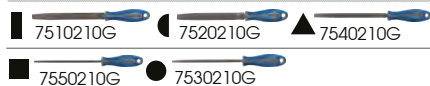

74A00

27€<sup>B</sup>

ALICATE SACABOCADOS DE REVÓLVER

Con 6 punzones intercambiables de diámetro: 2.0 / 2.5 / 3.0 / 3.0 / 3.5 / 4.0 / 4.5 mm.

New

Adecuado para acero inoxidable, acero templado, acero blando, cobre, latón, madera, fibra de vidrio y plásticos duros.



∅ 3 - 19 mm



∅ 13 - 35 mm



338A1119

25€<sup>B</sup>

HERRAMIENTA DE DESBARBADO Y BISELADO EXTERIOR PARA DESTORNILLADOR DE 1/4

Para desbarbar barras redondas, varillas roscadas, tornillos, tubos y piezas similares. Velocidad máxima de 0 a 400 rpm. Material de la plaquita de corte: acero rápido (HSS).

338A2135

68€<sup>B</sup>

MATERIAL DE LA PLAQUITA DE CORTE: ACERO RÁPIDO (HSS)

Para reparar espárragos de rueda, pernos y pasadores metálicos desbarbados dañados.

Mayor agarre y más ligereza



45°  
90°  
135°  
180°

300 mm

792112

20€<sup>B</sup>

792112

SIERRA PARA METALES MONTURA ALTAS PRESTACIONES



79410

ALICATES PARA DESENCOFRAR

Modelo forjado y tratado acero C40. Paleta y sacaclavos. Presentación lacada roja.

	A mm	B mm	C mm	D mm	L mm	kg	€ <sup>B</sup>
7941060	27	34	6	18	600	1425	21,40€ <sup>B</sup>
7941080	28	38	10	18	800	1875	25€ <sup>B</sup>

Cabezal del quemador de cerámica



llama ajustable

Cuerpo de aluminio

122 x 70 x 168 mm

400



6BB11

65€<sup>B</sup>

SOPLETE DE GAS BUTANO

Tipo de gas: butano (no incluido). Capacidad del depósito de gas: 34 ml. Temperatura máxima: 1300°C. Sistema anti-deslumbramiento para el uso del aparato en 360°.



6BJ21

63€<sup>B</sup>

PISTOLA DE PEGAMENTO INALÁMBRICA DE GAS BUTANO

Sin cable, es fácil de transportar y cómoda de usar. Se incluyen 2 ∅ barras de pegamento de 11 mm. Butano no incluido



**7CA8130H**

34€<sup>B</sup>

**PISTOLA DE CARTUCHOS DE ALTO EMPUJE**

Adecuado para cartuchos de 310 ml.  
Alto empuje con una relación de 26:1.  
Sustitución de cartuchos rápida y sencilla.  
Empuje máximo de 450 kg, perfecto para aplicar materiales gruesos.  
Aplicación: cristales, alfézares, baños, etc.



**7CA8230**

39€<sup>B</sup>

**PISTOLA DE CARTUCHOS DE ALUMINIO DE ALTO EMPUJE**

Adecuado para cartuchos de 310 ml.  
Alto empuje con una relación de 18:1.  
Incluye: 1 boquilla, 1 almohadilla.  
Empuje máximo de 350 kg, perfecto para aplicar materiales gruesos.  
Aplicación: cristales, alfézares, baños, etc.



**74020**

17€<sup>B</sup>

**CIZALLA TIPO "AVIACIÓN"**

Corte a la Derecha. Largo del corte: 35 mm.  
Cuchillas dentadas que reducen los deslizamientos sobre la chapa. Protección y empuñadura perfecta gracias a la salvaguarda del mango.  
Desmultiplicador de fuerza por resorte integrado.

**Capacidad de corte**

Cobre: 1,5 mm	Acero duro (HRC 30): 0,80 mm
Acero Laminado: 1,20 mm	Acero Inoxidable: 0,70 mm



**74060**

22€<sup>B</sup>

**CIZALLA TIPO "AVIACIÓN"**

Corte largo recto. Largo del corte 75 mm.  
Cuchillas dentadas que reducen los deslizamientos sobre la chapa. Protección y empuñadura perfecta gracias a la salvaguarda del mango.  
Desmultiplicador de fuerza por resorte integrado.

**Capacidad de corte**

Cobre: 1,1 mm	Acero duro (HRC 30): 0,70 mm
Acero Laminado: 0,94 mm	Acero Inoxidable: 0,53 mm



**74260**

20€<sup>B</sup>

**CIZALLA TIPO "AVIACIÓN" GRAN ESFUERZO**

Corte a la Derecha. Largo del corte: 35 mm.  
Cuchillas dentadas que reducen los deslizamientos sobre la chapa. Protección y empuñadura perfecta gracias a la salvaguarda del mango.  
Desmultiplicador de fuerza por resorte integrado.

**Capacidad de corte**

Cobre: 1,80 mm	Acero duro (HRC 30): 1 mm
Acero Laminado: 1,50 mm	Acero Inoxidable: 0,90 mm



**74270**

20€<sup>B</sup>

**CIZALLA TIPO "AVIACIÓN" GRAN ESFUERZO**

Corte largo recto. Largo del corte: 35 mm.  
Cuchillas dentadas que reducen los deslizamientos sobre la chapa. Protección y empuñadura perfecta gracias a la salvaguarda del mango.  
Desmultiplicador de fuerza por resorte integrado.

**Capacidad de corte**

Cobre: 1,80 mm	Acero duro (HRC 30): 1 mm
Acero Laminado: 1,50 mm	Acero Inoxidable: 0,90 mm



**79A2130**

13,50€<sup>B</sup>



**79A2230**

14€<sup>B</sup>

**CORDONES DE SEGURIDAD ANTI CAÍDA**

Permite evitar cualquier accidente causado por la caída de la herramienta.  
Con etiquetas de peso máximo autorizado.  
Peso de carga de 3 kg máximo.  
Cordón de nylon con resortes de acero que permite la absorción del choque durante la caída de una herramienta.

Capacidad mm

Tipo de sujeción

79A2130	800~1300	mosquetón
79A2230	800~1300	lazo elástico



16 PZAS

**DCJ330**

158€<sup>D</sup>

**COFRE DE SACABOCADOS**

Contiene

1.13

DCJ	Ø3, Ø4, Ø6, Ø8, Ø10, Ø12, Ø14, Ø16, Ø18, Ø20, Ø22, Ø24, Ø26, Ø28, Ø30
-----	---



32 PZAS

**DCJ250**

336€<sup>D</sup>

**COFRE DE SACABOCADOS**

Punta de centrado retráctil.

Contiene

2.60

DCJ	Ø2, Ø3, Ø4, Ø5, Ø6, Ø7, Ø8, Ø9, Ø10, Ø12, Ø14, Ø16, Ø18, Ø20, Ø22, Ø24, Ø26, Ø28, Ø30, Ø32, Ø34, Ø36, Ø38, Ø40, Ø42, Ø44, Ø46, Ø48, Ø50
-----	---

**GUANTES DE TRABAJO**



**9TH41L**  
**9TH41XL**

16€<sup>B</sup>



Ligeros de cuero sintético

**9TH42XL**  
**9TH42XXL**

30€<sup>B</sup>



Resistentes a los golpes y a las vibraciones

**9TH43XL**  
**9TH43XXL**

26€<sup>B</sup>



Antideslizantes de silicona sintética

**9TH44XL**  
**9TH44XXL**

30€<sup>B</sup>



Forro aislante de thinsulate sintético

**9TH45XL**  
**9TH45XXL**

26€<sup>B</sup>



Índices magnéticos

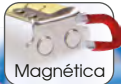

**79094M**

**CINTAS MÉTRICAS**

Aprobación CE - clase de precisión II. Bloqueo automático de la cinta. Irrompible. Mejor agarre. Anti-reflejos

Graduación en mm

<b>7909402M</b>	2 m x 16 mm	6,20€ <sup>B</sup>
<b>7909403M</b>	3 m x 16 mm	7,40€ <sup>B</sup>
<b>7909405M</b>	5 m x 19 mm	10€ <sup>B</sup>
<b>7909408M</b>	8 m x 25 mm	16,20€ <sup>B</sup>

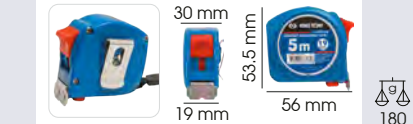

**7909505M**

7,30€<sup>B</sup>

**CINTA MÉTRICA LIGERA Y COMPACTA**

Aprobación CE - clase de precisión II. Graduación en mm. Cinta con revestimiento de nylon. Caja de ABS + TPE ergonómica y a prueba de golpes.



**7713308** 200 mm

70€<sup>B</sup>

**CALIBRE MANUAL**

Acero inoxidable acabado mate. Medida interior y exterior. Indicador de nivel. Bloqueo mediante tornillo. Graduación biselada para reducir el efecto de paralaje.



Reglaje mm

<b>7713308</b>	60	200	0.03
----------------	----	-----	------



**77142061** 150 mm

50€<sup>B</sup>

**CALIBRE DIGITAL**

Bloqueo mediante tornillo, moleta de reglaje de precisión. Pantalla digital. Salida para impresora. Función de puesta a cero. Conversión métrica en pulgada.

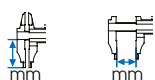

Precisión mm

<b>77142061</b>	40	150	0.01
-----------------	----	-----	------



100 toallitas

Fórmula con aceite esencial de limón



No se requiere agua

**ZD101100C**

26€<sup>B</sup>

**TOALLITAS MULTIUSO**

Deshágase de la grasa, el aceite, el alquitrán, la pintura, de la tierra, la silicona, los adhesivos y más. Limpia y protege eficazmente las manos de todo tipo de suciedad sin utilizar solventes tóxicos. Elimina hasta el 99,99% de las bacterias. En la lista de SVHC no REACH. En la lista de químicos no CA Prop 65. Solventes no tóxicos (SGS).

Adecuado para la limpieza de manos, superficies y herramientas



105

**7734020**

11€<sup>B</sup>

**GALGAS EN MÉTRICO DE 20 CUCHILLAS PUNTIAGUDAS**

Cuchillas de acero inoxidable. Grosor de las cuchillas: 0,05 a 1,00 mm.



**79063**

**REGLAS INOXIDABLES FLEXIBLES**

Doble graduación en métrica (recto) y en pulgadas (verso)

	A mm	E mm	L mm	g	€ <sup>B</sup>
<b>7906306</b>	14.7	0.6	150	12	1,50€ <sup>B</sup>
<b>7906312</b>	23.7	1	300	65	5€ <sup>B</sup>
<b>7906320</b>	28.5	1.2	500	145	11,90€ <sup>B</sup>
<b>7906340</b>	35	1.2	1000	360	20€ <sup>B</sup>

**New**



**77142081**

75€<sup>B</sup>

**CALIBRE DIGITAL**

Bloqueo mediante tornillo, moleta de reglaje de precisión. Pantalla digital. Salida para impresora. Función de puesta a cero. Conversión métrica en pulgada.

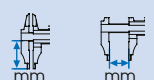

Precisión mm

<b>77142081</b>	50	200	0.01
-----------------	----	-----	------

# ILUMINACIÓN

## LAS LÁMPARAS DE INSPECCIÓN

**New**

525 mm

1.2kg

175 mm

360°

6000 K

1 W

100 lúmenes

79834A 29€<sup>B</sup>

180 mm

7200 K

1.5 W

145 lúmenes

180°

9TA28A 18€<sup>B</sup>

62471  
EYES SAFETY

9TA271

Seguridad fotobiológica. Iluminación uniforme sin puntos de calor.

Otra marca  
Iluminación parpadeante y desigual con puntos de calor perjudiciales.

260 mm

**New**

6500 K

3 W

600 lúmenes

180°

9TA271 33€<sup>B</sup>

	Luz	Temperatura de color de la luz	Dimensiones	Autonomía	Tiempo de carga	Batería Li-Ion	USB	Índice de protección	g
79834A	30 / 100 lm	6000 K	21 x 175 / 525 mm	2 ~ 6 h	2.5 h	3.7V - 180 mAh	◀ USB-C	IP65, IK09	89
9TA28A	COB : 145 lm - LED : 80 lm	7200 K	L : 180 mm	2 h	2 h	3.7 V - 800 mAh	◀ USB-C	-	100
9TA271	COB: 250 / 600, SMD: 120 lm	6500 K	L : 260 mm	3 ~ 12 h	3.5 h	3.7 V - 2600 mAh	◀ USB-C	IP54, IK07, EN62471	186
9TA56A	30 / 60 / 170 lm	5700 K	210 x 225 mm	2 ~ 6 h	2 h	3.7 V - 250 mAh	◀ USB-A	IP20, IK07	100
9TA561A	30 / 60 / 170 lm	5700 K	210 x 225 mm	2 ~ 6 h	2 h	3.7 V - 250 mAh	◀ USB-A	IP20, IK07	120
9TA52AA	100/280 lm	6500 K	L : 65 mm	2 ~ 5 h	2.5 h	3.7 V - 1500 mAh	◀ Micro USB-B	IP65	110

Usb (salida powerbank) : ▶ Usb (entrada) : ◀

210 mm

225 mm

5700 K

170 lúmenes

100% ACRÍLICO

9TA56A 16€<sup>B</sup>

210 mm

225 mm

5700 K

170 lúmenes

100% ACRÍLICO

9TA561A 22€<sup>B</sup>

6500 K

3 W

280 lúmenes

65 mm

60°

10 cm

DETECTOR DE MOVIMIENTOS INTUITIVO

9TA52AA 54€<sup>B</sup>

1 AÑO DE GARANTÍA

**New**

260 mm

USB POWERBANK

180°

6500 K

7 W

700 lúmenes

**9TA242AA** 69€<sup>B</sup>

305 mm

AI<sup>13</sup> ALUMINIO

6500 K

8 W

800 lúmenes

**9TA268AA** 67€<sup>B</sup>

400 mm

REGULABLE

+/- 6500 K

7 W

600 lúmenes

**9TA262AA** 76€<sup>B</sup>

	Luz	Temperatura de color de la luz	Dimensiones	Autonomía	Tiempo de carga	Batería Li-Ion	USB	Índice de protección	IP
9TA242AA	COB: 150 / 350 / 700, SMD: 200 lm	6500 K	L : 260 mm	2 ~ 8 h	4 h	3.7 V - 2600 mAh	◀ USB-C	IP65, IK07	396
9TA268AA	COB : 120 - 150 / 800 - SMD : 120 / 400 lm	6500 K	L : 162 / 303 mm	COB : 2,5 ~ 8 h - SMD : 4 ~ 9 h	4 h	3.7 V - 2600 mAh	◀ USB-C	IP54, IK07	193
9TA262AA	COB : 600 - SMD : 120 lm	6000 K - 7000 K	L : 385 mm	2 ~ 15 h	4 h	3.7 V - 2600 mAh	◀ USB-C	IP54, IK07	300
9TA54A	180 / 350 lm	6500 K	230 x 130 x 45 mm	2.2 ~ 5.5 h	2.5 h	3.7 V - 700 mAh	◀ USB-C	IP54, IK07	140
9TA44W	COB : 160 / 400 / 800 - SMD : 250 lm	6500 K	97 x 83 x 39 mm	2.5 ~ 10 h	4 h	3.7 V - 2600 mAh	◀ USB-C	IP65, IK07	218

Usb (salida powerbank) : ▶ Usb (entrada) : ◀

120°

+/- 6500 K

3,5 W

350 lúmenes

**9TA54A** 54€<sup>B</sup>

97 mm

6500 K

8 W

800 lúmenes

COMPATIBLE CON CARGA INALÁMBRICA POR INDUCCIÓN

**9TA44W** 62€<sup>B</sup>

LOS FOCOS

**9TA48P05A** 17€<sup>B</sup>



CANTIDAD LIMITADA

CANTIDAD LIMITADA

288 mm



**9TA48AA** 129€<sup>B</sup>

6500 K ▲  
30 W  
3000 lúmenes

USB POWERBANK ALUMINIO

**9TA46AA** 212€<sup>B</sup>

6500 K ▲  
40 W  
4000 lúmenes

USB POWERBANK

**9TA45AA** 199€<sup>B</sup>

5700 K ▲  
45 W  
4500 lúmenes

USB POWERBANK

	Luz	Temperatura de color de la luz	Dimensiones	Autonomía	Tiempo de carga	Batería Li-Ion	USB	Índice de protección	Índice de equilibrio
9TA48AA	300 / 750 / 1500 / 2250 / 3000 lm	6500 K	205 x 153 x 75 mm	3 ~ 25 h	4.5 h	7.4 V - 5200 mAh	◀ USB-A USB-C ▶	IP65, IK07	960
9TA46AA	400 / 4000 lm	6500 K	210 x 210 x 100 mm	3.5 ~ 12 h	3.5 h	11.1 V - 5200 mAh	USB-A ▶	IP65, IK07	1450
9TA45AA	750 / 1500 / 3000 / 4500 lm	5700 K	288 x 176 x 131 mm	2 ~ 12 h	4.5 h	14.8 V - 5200 mAh	USB-A ▶	IP54, IK07	2140
9TA491AA	600 / 1200 / 2400 / 6000 lm	2700 - 6500 K	142 x 142 x 1200 mm	2 ~ 16 h	4.5 h	14.8 V - 5200 mAh	◀ Cable de carga	IP65, IK07	4400

Usb (salida powerbank) : ▶ Usb (entrada) : ◀

1500 mm  
700 mm  
3 kg

**87162KA** 39€<sup>B</sup>

**New**

**9TA48AA** x2

**87162KA**

**9TA48AZ** 289€<sup>B</sup>

Disponible a finales de marzo

**New**

**9TA421AA**

**87162KA**

**9TA421AZ** 113€<sup>B</sup>

**New**

90°  
330°

6500 K ▲  
60 W  
6000 lúmenes

**9TA491AA** 269€<sup>B</sup>

Oferta válida del 01/01/2025 al 31/12/2025. Precio recomendado de venta al público en euros sin IVA. Fotos no contractuales.



**New**

270 mm

Disponible a finales de marzo

6500 K  
▲  
30 W  
**3000 lúmenes**

9TA421AA 79€<sup>B</sup>

**New**

176 mm

Disponible en marzo

6500 K  
▲  
16 W  
**1600 lúmenes**

9TA471A 82€<sup>B</sup>

	Luz	Temperatura de color de la luz	Dimensiones	Autonomía	Tiempo de carga	Batería Li-ion	USB	Índice de protección	IP
9TA421AA	1500 / 3000 lm	6500 K	240 x 270 x 55 mm					IP54, IK08	1393
9TA471A	100 / 300 / 700 / 1600 lm	6500 K	176 x 105 x 95 mm	3 ~ 24 h	5 h	3.7 V - 5200 mAh	◀ USB-C	IP65, IK07	625
9TA33AA	400/1000 lm	6500 K	L : 500 mm	2.2 ~ 5.5 h	4.5 h	7.4 V - 2600 mAh	◀ USB-C	IP20, IK07	487
9TA34AA	500/1000/2000 lm	6500 K	L : 1170 ~ 1900 mm	2 ~ 6.5 h	4 h	3.6 V - 4800 mAh	◀ USB-C	IP20, IK07	1110

Usb (salida powerbank) : ▶ Usb (entrada) : ◀

### LÁMPARAS DE TRABAJO DEBAJO DEL CAPÓ

6500 K  
▲  
10 W  
**1000 lúmenes**

9TA33AA 60€<sup>B</sup>

500 mm

360°



9TA34AA 137€<sup>B</sup>

6500 K  
▲  
20 W  
**2000 lúmenes**

9TA34P01A 32€<sup>B</sup>

BATERÍA LI-ION RECARGABLE:  
3,6 V y 4800 mAh

1170 mm min. 1900 mm max.

360°



87163 81€<sup>B</sup>

850 mm 1450 mm 2100 mm

1.3

9TA44W 1600 lúmenes

6500 K  
▲  
16 W

9TA44AZ 202€<sup>B</sup>

Contiene

9TA44W x2 87163

COMPATIBLE CON CARGA INALÁMBRICA POR INDUCCIÓN



# MOBILIARIO Y COMPOSICIONES DE HERRAMIENTAS

## MOBILIARIO MÓVIL



**CANTIDAD LIMITADA**

**8714101B**

18,60€<sup>B</sup>

### ESTUCHE CON SEPARADORES EXTRAÍBLES

Con separadores extraíbles para crear compartimentos de distintos tamaños según las necesidades. La tapa transparente facilita la búsqueda de las piezas necesarias. Diseñado para apilar fácilmente varias cajas. El material duradero protege las piezas durante el transporte.

0.79

376 x 290 x 67 mm



**87723B**

79€<sup>B</sup>

14 BOLSILLOS

### MOCHILA MULTIUSOS

20 kg



Gran apertura para un fácil acceso a herramientas



Tejido impermeable oxford de 600 denier



Base en PVC

1.6



Respaldo con almohadillas aiveoladas que absorben las vibraciones y aumentan la ventilación.



Correa pectoral ajustable.



Correa de velcro en la parte trasera diseñada para sujetar la mochila a un asa.

Las herramientas mostradas no están incluidas.



39 BOLSILLOS

Tejido impermeable oxford de 600 denier

510 x 345 x 260 mm

3.0

**87711C**

99€<sup>B</sup>

### CAJA DE HERRAMIENTAS TEXTIL



Las herramientas mostradas no están incluidas.

**CANTIDAD LIMITADA**



445 x 240 x 206 mm

1.74

**87407M**

25€<sup>D</sup>

### CAJA DE HERRAMIENTAS DE PLÁSTICO

Bandeja móvil con emplazamiento para la tornillería. Apertura frontal. Material de polipropileno. Porta candado incluido.

**BASIC**  
series



2.2

**87A03AUS**

21 €

**CAJA DE HERRAMIENTAS METÁLICA  
1 COMPARTIMENTO CON BANDEJA**



**BASIC**  
series

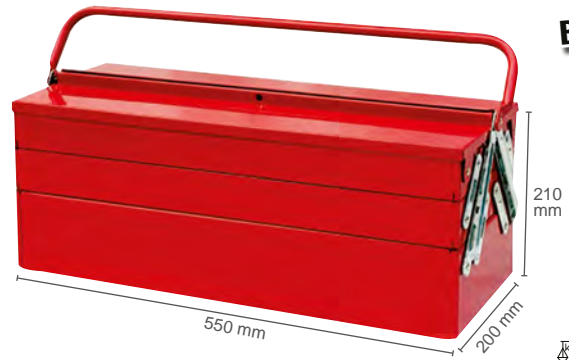

5.3

**87A02AUS**

53 €

**CAJA DE HERRAMIENTAS METÁLICA  
5 COMPARTIMENTOS SOBRE 3 NIVELES**

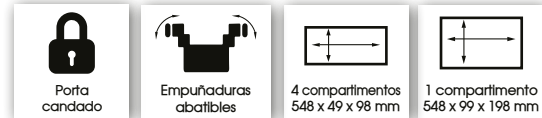

**87A08**

37 €

**CAJA DE HERRAMIENTAS METÁLICA Y PLÁSTICO**

Carcasa reforzada a prueba de choques en polipropileno.

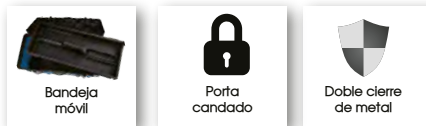

2.0



**BASIC**  
series

Existe en 2 colores



**87A05A0KB**

53 €

**87A05A0KG**

53 €

**CAJA DE HERRAMIENTAS METÁLICA BASIC**

Dimensiones totales: 470 x 220 x 260 mm

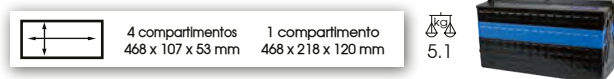

5.1

**87A051A0KB XL**

58 €

**87A051A0KG XL**

58 €

**CAJA DE HERRAMIENTAS METÁLICA BASIC XL**

Dimensiones totales: 530 x 220 x 260 mm

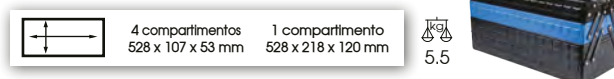

5.5

**STRENGTH**  
series



**Más robusto**  
De chapa de 0,7 mm de grosor



**87402**

89 €

**CAJA DE HERRAMIENTAS METÁLICA STRENGTH**

Dimensiones totales: 470 x 220 x 260 mm



5.6

**87408 XL**

116 €

**CAJA DE HERRAMIENTAS METÁLICA STRENGTH XL**

Dimensiones totales: 530 x 220 x 260 mm



6.7

128  
PZAS



21  
PZAS



**415147ELC1**

570€<sup>D</sup>

Electricidad - Electromecánica

Contiene

9.08



87404

- 2335M 4, 4.5, 5, 5.5, 6, 7, 8, 9, 10, 11, 12, 13
- 1062 5.5, 6, 7, 8, 9, 10, 11, 12, 13, 14, 16, 17, 18, 19
- 1422 6.5 x 38, 3 x 75, 4 x 100, 5.5 x 125, 6.5 x 150, 8 x 175
- 1421 PH1 x 80, PH2 x 100
- 2221 55, 150 mm
- 2755G 2178DF 2792
- 6CB02 6BC141 2141
- 1025P PH1, PH2, PH3
- 1025Z PZ1, PZ2, PZ3
- 1025S 4, 6.5, 7, 8
- 1025U T8H, T9H, T10H, T15H, T20H, T25H, T27H, T30H, T40H
- 1025H 2.5, 3, 4, 5, 6, 7, 8, 10
- 1472 4 x 100
- 2121 6314 6214
- 6BD11 6AB1255 6BF1125
- 1431 PH000 x 75, PH00 x 75, PH0 x 75, PH1 x 75
- 1432 1.5 x 75, 2.0 x 75, 3.0 x 75
- 1125M H1.5, H2, H2.5, H3, H4, H5, H6, H8, H10
- 761 Ø3
- 764 Ø2, Ø3.4, Ø4, Ø5
- 7842\_PAH 7734020
- 7951212 675144
- 79093M 9DC23
- 6116A 6216A
- 6318A 6516A



45115PP



1026GQ

**41521ELECT**

302€<sup>D</sup>

Electricista

Contiene

4.8



87407M

- 1471 PH0 x 75, PH1 x 100, PH2 x 100, PH3 x 150
- 1472 3 x 75, 4 x 100, 5.5 x 125, 6.5 x 150, 8.0 x 175
- 6334 6214
- 6318A 6116A 6761A
- 6516A 6216A 6146A
- 7932 675144 6721



**902A026MR**

26  
PZAS

189€<sup>D</sup>

Contiene

6.04

- 1060 8, 10, 12, 13, 14, 17, 19, 21, 22, 24
- 1421 PH1 x 80, PH2 x 100
- 1422 3 x 75, 4 x 100, 5.5 x 125, 6.5 x 150, 8 x 175
- 764 Ø 2 x 30, Ø 3 x 40, Ø 4 x 50, Ø 5 x 50, Ø 6 x 50, Ø 8 x 50
- 651610C 361112R
- 786238 87A03AUS

**902A039MR 1/2"**

39  
PZAS

245€<sup>D</sup>

Contiene

7.59

- 4335M 8, 10, 11, 12, 13, 14, 15, 16, 17, 18, 19
- 477110G 425106

\*Garantía ilimitada en el tiempo, salvo cinta métrica, cuchillas de sierra, herramientas de golpe, caja de herramientas y puntas 1/4".

Oferta válida del 01/01/2025 al 31/12/2025. Precio recomendado de venta al público en euros sin IVA. Fotos no contractuales.



1/2"

42  
PZAS

41542MRV

1/2"

219 € B

Contiene 6.2

	4335M	10, 11, 13, 14, 15, 16, 17, 18, 19, 21, 22, 24			
	1062	8, 9, 10, 11, 12, 13, 14, 17, 18, 19, 22, 24			
	1422	3 x 75, 5.5 x 100, 6.5 x 150			
	1421	PH0 x 60, PH1 x 100, PH2 x 100			
	1130M	H2.5, H3, H4, H5, H6, H8, H10			
	477110G		425105		4791
	361108R		611106		87A08

STRENGTH  
series

1/2"



470 x 220 x 260 mm



902076MR



902091MR



902089MR03



902103MR07



902083MR



902098MR1

902076MR

1/2"

76  
PZAS

395 € D

902091MR

1/2"

91  
PZAS

579 € D

902089MR03

88  
PZAS

549 € D

902103MR07

103  
PZAS

699 € D

902083MR

83  
PZAS

514 € D

902098MR1

98  
PZAS

659 € D

Contiene 17.70

Contiene 24.8

	4335M	10, 11, 12, 13, 14, 15, 16, 17, 18, 19, 20, 21, 22, 23, 24, 27, 30, 32					
	475510G		4791R				
	463521R		425105R, 425110R				
	457212		445218FR		422302R		
	1062	6, 7, 8, 9, 10, 11, 12, 13, 14, 15, 16, 17, 18, 19, 20, 21, 22, 24					
	1900	6 x 7, 8 x 10, 11 x 13, 12 x 13, 17x19, 22 x 24					
	1120MR	H1.5, H2, H2.5, H3, H4, H5, H6, H8, H10					
	1147	T10H, T15H, T20H, T25H, T27H, T30H, T40H					
	1421	PH2 x 38, PH3 x 150					
	1422	3 x 75, 5 x 100					
	611107		631106		651610C		
	782180		361108R		791112		87402

	4335M	10, 11, 12, 13, 14, 15, 16, 17, 18, 19, 20, 21, 22, 23, 24, 27, 30, 32			
	475510G		4791R		
	463521R		425105R, 425110R		
	457212		445218FR		422302R
	1062	8, 9, 10, 11, 12, 13, 14, 15, 16, 17, 18, 19, 21, 22, 23, 24, 27, 30, 32			
	1120MR	H1.5, H2, H2.5, H3, H4, H5, H6, H8, H10			
	1147	T10H, T15H, T20H, T25H, T27H, T30H, T40H			
	1421	PH0 x 60, PH1 x 100, PH2 x 100, PH3 x 150			
	1422	3 x 75, 4 x 100, 5 x 75, 5.5 x 125, 6.5 x 150, 8 x 175			
	611107		631106		651610C
	623208		643110		601110R
	782180		361112R		791112
	2x115, 3x125, 4x150, 5x165, 6x180, 8x200, 12x230, 14x250				
	20x175, 26x300		7909303C		87402

Las diferencias entre los dos modelos se indican en negra.

INCLUIDO EN 902089MR03 / 902103MR07

Contiene

	1812MR		1080	8, 10, 11, 12, 13, 14, 16, 17, 18, 19, 22, 24
--	--------	--	------	---

INCLUIDO EN 902083MR / 902098MR1

Reversible

Contiene

	373A	8, 10, 11, 12, 13, 17, 19
--	------	---------------------------

122A07MRN01

\*Garantía ilimitada en el tiempo, salvo cinta métrica, cuchillas de sierra, herramientas de golpe y caja de herramientas

Oferta válida del 01/01/2025 al 31/12/2025. Precio recomendado de venta al público en euros sin IVA. Fotos no contractuales.

GARANTÍA ILIMITADA\*

902100MKB2

1/4" + 1/2"

100  
PZAS

459€ D

902100MKG2

1/4" + 1/2"

100  
PZAS

459€ D

**BASIC**  
series



Garantía ilimitada en el tiempo, salvo cutter, cinta métrica, lámpara bórgrafa y caja de herramientas.

902100MKB2

902100MKG2

1/4" 1/2"

Contiene

13.17

2335M	4, 4.5, 5, 5.5, 6, 7, 8, 9, 10, 11, 12, 13
4335M	10, 11, 12, 13, 14, 15, 16, 17, 18, 19, 21, 22, 24
277155G	477910G
222104	4791 2142
1421	PH1x80, PH2x100, PH3x150
1422	5.5x100, 6.5x150, 8.0x175
1062	8, 10, 11, 12, 13, 14, 15, 16, 17, 18, 19, 21, 22, 24
651710C	611107 621106
631106	797707 7909505M
9TA28A	87A05A0KB / 87A05A0KG
1120MR	H1.5, H2, H2.5, H3, H4, H5, H6, H8, H10
1025H	H3, H4, H5, H6
1025P	PH1, PH2, PH2, PH3
1025S	3, 4, 5, 6
1025Z	PZ1, PZ2, PZ2, PZ3
1025T	T10, T15, T20, T25, T27, T30, T40
1025U	T10H, T15H, T20H, T25H, T27H, T30H, T40H
425110	457212
75363	770225

908077MR01

1/2" + 3/4"

77  
PZAS

579€ D

1/2" 3/4"

Contiene

19.5

4335M	7, 8, 9, 10, 11, 12, 13, 14, 15, 16, 17, 18, 19, 21, 22, 23, 24, 26, 27, 28, 30, 32
4025	H5, H6, H8, H10, H12, H14
463521R	463521R
477910G	4572
425103, 425105, 425110	4791
6330M	33, 36, 38, 41, 46, 50
677920F	657220
625108, 625116	
1060	8, 10, 11, 12, 13, 14, 17, 18, 19, 21, 24, 27, 30, 32
1461	PH1 x 75, PH2 x 100, PH3 x 150
1462	5.5 x 100, 6.5 x 150, 8 x 175
1145M	H1.5, H2, H2.5, H3, H4, H5, H6, H8, H10
36110P	65110C
XL 87408	

**STRENGTH**  
series



**STRENGTH**  
series



Cierre centralizado con llave	Chapa de 0.8 mm	Empuñaduras laterales	100% Cajones sobre correderas de bolas	Cajones reforzados
-------------------------------	-----------------	-----------------------	--	--------------------

874213B

219€ D

COFRES METÁLICOS

	Características	Dimensiones (mm) L x P x H	kg
874213B	Total	660 x 307 x 251	13
	2 cajones	569 x 275 x 50	
	1 cajones	569 x 275 x 75	



\*Garantía ilimitada en el tiempo, salvo cinta métrica, cuchillas de sierra, herramientas de golpe, caja de herramientas y puntas 1/4".

Oferta válida del 01/01/2025 al 31/12/2025. Precio recomendado de venta al público en euros sin IVA. Fotos no contractuales.

**STRENGTH**  
series



**874116B** 356 € <sup>D</sup> **874119B** 419 € <sup>D</sup>

**COFRES METÁLICOS**

	Características	Dimensiones (mm) L x P x H	kg
874116B	Total	660 x 307 x 374	25.4
	1 compartimento	646 x 290 x 60	
	3 cajones	170 x 275 x 50	
	2 cajones	569 x 275 x 50	
874119B	1 cajón	569 x 275 x 75	30.2
	Total	660 x 307 x 427	
	1 compartimento	646 x 290 x 60	
	6 cajones	170 x 275 x 50	
	2 cajones	569 x 275 x 50	
	1 cajón	569 x 275 x 75	



**STRENGTH XL**  
series



**8741710BG** 639 € <sup>D</sup> **874195B** 519 € <sup>D</sup>

**COFRE METÁLICO TRANSPORTABLE XL**

	Características	Dimensiones (mm) L x P x H	kg
8741710BG	Total	660 x 455 x 483	51.2
	1 compartimento	646 x 420 x 70	
	6 cajones	169 x 410 x 48.5	
	1 cajón	169 x 410 x 154	
874195B	2 cajones	576 x 410 x 48.5	40
	1 cajón	576 x 410 x 75	
	Total	660 x 455 x 483	
	1 compartimento	646 x 420 x 70	
	3 cajones	576 x 410 x 75	
	2 cajones	576 x 410 x 48.5	



**87A09A** 6.60 € <sup>B</sup>

**BANDEJA PORTAHERRAMIENTAS PORTÁTIL**

Cubo profundo con ranuras para herramientas. La combinación de PP y mango de aluminio hace que el producto sea ligero pero robusto, ofreciendo una excelente resistencia estructural y durabilidad. Equipado con ranuras BITS seguras y múltiples compartimentos, mantiene las herramientas organizadas y evita que se caigan.



La bandeja tiene 7 ranuras para brocas en su interior, lo que garantiza la estabilidad y un fácil acceso sin riesgo de caídas.

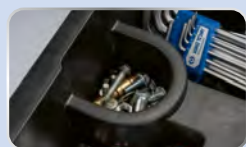

El compartimento de almacenamiento curvado mantiene las piezas pequeñas seguras y de fácil acceso.



Puede colocarse dentro de su carro o estación de trabajo, proporcionando un almacenamiento eficaz y un acceso rápido a las herramientas.



Asa metálica para facilitar el transporte.



Las bandejas vacías pueden aplastarse para ahorrar espacio.

**911000CR07** 1/4"+3/8"+1/2" 1190€<sup>D</sup>

Dimensiones en pulgadas y métricas.

Contiene		48.1
2335M	4, 4.5, 5, 5.5, 6, 7, 8, 9, 10, 11, 12, 13	463516M, 463521R
2335S	5/32", 3/16", 7/32", 1/4", 9/32", 5/16", 11/32", 3/8", 7/16", 1/2"	2792 3792
2235M	4, 5, 5.5, 6, 7, 8, 9, 10, 11, 12, 13	4791
2235S	5/32", 3/16", 7/32", 1/4", 9/32", 5/16", 11/32", 3/8", 7/16", 1/2"	322103, 322106
3330M	6, 7, 8, 9, 10, 11, 12, 13, 14, 15, 16, 17, 19, 20, 21, 22	345208F
3330S	3/8", 7/6", 1/2", 9/16", 5/8", 11/16", 3/4", 13/16"	357108
4330M	10, 11, 12, 13, 14, 15, 16, 17, 18, 19, 20, 21, 22, 23, 24, 27, 30, 32	425105R, 425110R
4330S	3/8", 7/16", 1/2", 9/16", 5/8", 11/16", 3/4", 13/16", 7/8", 15/16", 1"	445215F
1900	8 x 9, 10 x 11, 12 x 13, 14 x 15, 18 x 19	457210
5900	1/4"x5/16", 3/8"x7/16", 7/16"x1/2", 9/16"x5/8", 11/16"x3/4", 13/16"x7/8"	361108P, 361112P
1062	6, 7, 8, 9, 10, 11, 12, 13, 14, 15, 16, 17, 19, 20, 21	623107 631106
5060	1/4", 5/16", 3/8", 7/16", 1/2", 9/16", 5/8", 11/16", 3/4", 13/16", 7/8", 1"	611107 651110C
1970	6x7, 8x9, 10x11, 12x13, 14x15, 16x17, 18x19	68SB07 631106
5970	1/4"x5/16", 3/8"x7/16", 1/2"x9/16", 5/8"x11/16", 3/4"x7/8", 15/16"x1", 1-1/16"x1-1/8"	68HS07 68SS07
1930	10 x 11, 12 x 14, 14 x 17	601110R
1120MR	H1.5, H2, H2.5, H3, H4, H5, H6, H8, H10	7640406, 7640607, 7640808
1130S	3/32", 1/8", 5/32", 3/16", 1/4", 5/16", 3/8"	7621505, 7621706, 7622007, 7622410
1421	PH0, PH1, PH2, PH2, PH3	7610506
1422	3x75, 6.5x38, 6.5 x 100, 6.5x150, 8x175	781116OS
277955G	377908G	477910G
2813	3812	4813
		222102, 222104
		874116B



660 x 374 x 307 mm

MODULAR STACKING BOX **M6** BOX



<b>S</b>   874051	15kg	62€ <sup>D</sup>
456 x 372 x 115 mm		
<b>M</b>   874052	15kg	69€ <sup>D</sup>
456 x 372 x 155 mm		
<b>L</b>   874053	15kg	83€ <sup>D</sup>
456 x 372 x 262 mm		
<b>874059</b>	90kg	76€ <sup>D</sup>
655 x 490 x 170 mm		

**SOPORTE CON RUEDAS**



**9052002MRV** 469€<sup>D</sup>

CAJA DE HERRAMIENTAS «LO ESENCIAL»

Contiene		10.46
2335M	4, 4.5, 5, 5.5, 6, 7, 8, 9, 10, 11, 12, 13, 14	
4335M	10, 13, 15, 16, 17, 18, 19, 20, 21, 22, 24, 27, 30, 32	
275555G	477310GS	2179DF
2142		
425110R	2792	4791
75363	770225	
1120MR	H1.5, H2, H2.5, H3, H4, H5, H6, H8, H10	20002UB
1147R	T10H, T15H, T20H, T25H, T27H, T30H, T40H, T45H, T50H	
1025H	H3, H4, H5, H6	1025P PH1, PH2 x 2, PH3
1025S	3.0, 4.0, 5.0, 6.0	
1025T	T10, T15, T20, T25, T27, T30, T40	
1025U	T10H, T15H, T20H, T25H, T27H, T30H, T40H	
1025Z	PZ1, PZ2 x 2, PZ3	
Ø 4 x 120	15 x 125	3 x 120
Ø 4 x 150	5 x 130	782130OS
1062	8, 9, 10, 11, 12, 13, 14, 16, 17, 18, 19, 22	361110R
631108	651110	621106
611107		
6AB3175	9TA281	7909505M
		874052

112 PZAS



\*Garantía ilimitada en el tiempo, salvo herramientas de golpe, caja de herramientas y puntas 1/4".



## MOBILIARIO PARA TALLER

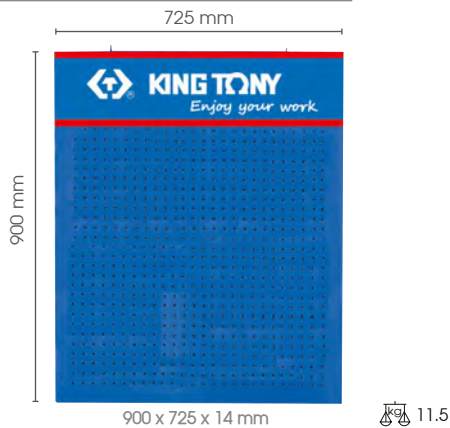

**87203**

165 € <sup>B</sup>

### PANEL PERFORADO MURAL

Suministrado con 30 ganchos.

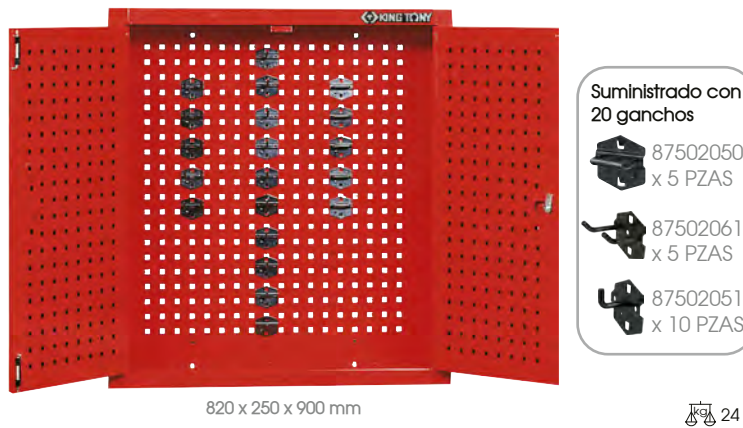

**87201**

459 € <sup>D</sup>

### ARMARIO MURAL DE TALLER

Apertura de las puertas a 180°. Cierre centralizado con llave  
Posibilidad de bloquear sólo la puerta izquierda (sólo 1 puerta abierta de las 2).

**BASIC**  
series

**6**  
CAJONES



Existe en 3 colores



87G386BA 87G386BAB 87G386BAG

**87G386BA(-B/-G)**

490 € <sup>D</sup>

### CARRO PARA TALLER BASIC - 6 CAJONES



	Características	Dimensiones (mm)		kg
		L x P x H		
87G386BA	Total sin ruedas	812	758 x 455	53.7
	Total + ruedas de Ø 127x50 mm	968	758 x 455	
	3 cajones	573	407 x 63	
	3 cajones	573	407 x 141	

**BASIC**  
series

**87G341A**

33 € <sup>B</sup>

### BANDEJA PARA HERRAMIENTAS

Compatible con 87G386BA(-B/-G).

**PRO**  
series

**7**  
CAJONES



Existe en 2 colores



ST874347B ST874347BPG

**ST874347B(-PG)**

599 € <sup>D</sup>

### CARRO PARA TALLER PRO - 7 CAJONES

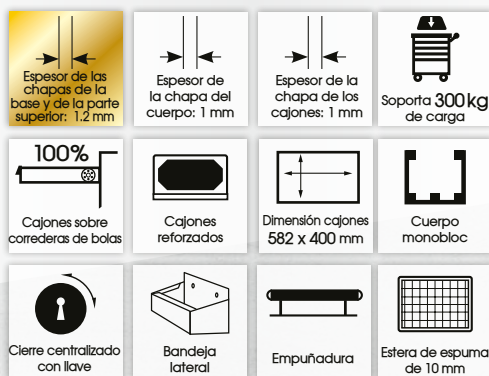

	Características	Dimensiones (mm)		kg
		L x P x H		
ST874347B (-PG)	Total	670	460 x 813	64
	Total + ruedas de Ø 127x32 mm	670	460 x 986	
	5 cajones	582	400 x 76	
	2 cajones	582	400 x 156	

**STRENGTH**  
series

**5**  
CAJONES



87502 + 874315BT



**874315BT**

529€ <sup>D</sup>

**CARRO PARA TALLER STRENGTH - 5 CAJONES**

Chapa de 1.2 mm	Soporta 250 kg de carga	Cuerpo monobloc	Cierre centralizado con llave
100% Cajones sobre correderas de bolas	Cajones reforzados	Dimensión cajones 576 x 380 mm	Estera de espuma de 10 mm

Características	Dimensiones (mm) L x P x H		kg
	Total	Total + ruedas de Ø101 x 32 mm	
874315BT	670 x 460 x 654	670 x 460 x 785	50
3 cajones	576 x 380 x 75		
2 cajones	576 x 380 x 154		

**BUMPER**  
series

**7**  
CAJONES



876347B

876347BB

876347BG

**876347B(-B/-G)**

899€ <sup>D</sup>

**CARRO PARA TALLER BUMPER - 7 CAJONES**

Antigolpes	Espesor de las chapas de la base y de la parte superior: 1.2 mm	Espesor de la chapa del cuerpo: 1 mm	Espesor de la chapa de los cajones: 1 mm	Soporta 360 kg de carga
Cuerpo monobloc	Cierre centralizado con llave	100% Cajones sobre correderas de bolas	Dimensión cajones 576 x 380 mm	Cajones reforzados
Empuñadura	Bandeja lateral	Estera de espuma de 10 mm		

Características	Dimensiones (mm) L x P x H		kg
	Total	Total + ruedas de Ø127x32 mm	
876347B	820 x 475 x 775	820 x 475 x 940	68.14
5 cajones	576 x 380 x 75		
2 cajones	576 x 380 x 154		

**BUMPER**  
**RFS** series

**8**  
CAJONES



\*RFS - Risk-Free System:  
Sistema sin riesgo

**876348GG**

999€ <sup>D</sup>

**CARRO PARA TALLER BUMPER RFS - 8 CAJONES**

Solo se puede abrir un cajón a la vez para evitar que se vuelque el carro

Antigolpes	Sistema RFS*	Espesor de las chapas de la base y de la parte superior: 1.2 mm	Espesor de la chapa del cuerpo: 1 mm	Espesor de la chapa de los cajones: 1 mm
Soporta 360 kg de carga	Cuerpo monobloc	100% Cajones sobre correderas de bolas	Dimensión cajones 576 x 380 mm	Cajones reforzados
Cierre centralizado con llave	Empuñadura	Bandeja lateral	Estera de espuma de 10 mm	

Características	Dimensiones (mm) L x P x H		kg
	Total	Total + ruedas de Ø127x32 mm	
876348GG	820 x 475 x 775	820 x 475 x 940	68.14
7 cajones	576 x 380 x 75		
1 cajón	576 x 380 x 154		

# SQUAD



## 6

**CAJONES**

**87SQ316BABK** 665 €



## 7

**CAJONES**

**87SQ317BABK** 689 €



## 8

**CAJONES**

**87SQ318BABK** 710 €

CARRO PARA TALLER MODELO D - 6 CAJONES

CARRO PARA TALLER MODELO D - 7 CAJONES

CARRO PARA TALLER MODELO D - 8 CAJONES

Antigolpes	Sistema RFS*	Espesor de la chapa del cuerpo: 1 mm	Espesor de la chapa de los cajones: 0.8 mm	500 kg	Cierre centralizado con llave
35 kg	30 kg	100% Cajones sobre correderas de bolas	570x380 mm	Cajones reforzados	

Características	Dimensiones L x P x H (mm)		kg
	Total	Total + ruedas de Ø 127 x 50.8 mm	
87SQ31_BABK	696x473x805	696x473x994	-
87SQ316BABK	3 cajones	570x380x70	65
87SQ317BABK	3 cajones	570x380x150	68
87SQ318BABK	5 cajones	570x380x70	71
87SQ318BABK	2 cajones	570x380x150	71
87SQ318BABK	7 cajones	570x380x70	71
87SQ318BABK	1 cajón	570x380x150	71



# SQUAD

Disponible en marzo

**87SQ337BABK** 859 €

CARRO PARA TALLER XL MODELO D+ - 7 CAJONES

Sistema RFS*	Antigolpes	Espesor de la chapa del cuerpo: 1 mm	Espesor de la chapa de los cajones: 1 mm	700 kg	Cierre centralizado con llave
35 kg	30 kg	100% Cajones sobre correderas de bolas	850x380 mm	Cajones reforzados	



Características	Dimensiones L x P x H (mm)		kg
	Total	Total + ruedas de Ø 127 x 50.8 mm	
87SQ337BABK	981x473x805	981x473x994	85
87SQ337BABK	5 cajones	850x380x70	85
87SQ337BABK	2 cajones	850x380x150	85

New

SQUAD

87SQ327BABK

913€<sup>D</sup>

CARRO PARA TALLER SQUAD MODELO D7X  
- 7 CAJONES + 1 PUERTA CON ESTANTE



Antigolpes	Sistema RFS*	Espesor de la chapa del cuerpo: 1 mm	Espesor de la chapa de los cajones: 0.8 mm	700 kg	Cierre centralizado con llave
35 kg	30 kg	850x380 mm	570x380 mm	100% Cajones sobre correderas de bolas	Cajones reforzados

87SQ327BABK	Características		Dimensiones L x P x H (mm)		85
	Total	Total + ruedas de Ø 127 x 50.8 mm	1 cajón	4 cajones	
		1081 x 473 x 868	850 x 380 x 80	570 x 380 x 70	
			570 x 380 x 150	295 x 455 x 635	
			Compartimento grande		

SQUAD

Superb Workbench

87SQ3410BABK

1519€<sup>D</sup>

BANCO SUPERB WORKBENCH - 10 CAJONES - 3 ARMARIOS



Antigolpes	Sistema RFS*	Espesor de la chapa del cuerpo: 1 mm	Espesor de la chapa de los cajones: 0.8 mm	700 kg	Cierre centralizado con llave
35 kg	30 kg	25 kg	570x380 mm	100% Cajones sobre correderas de bolas	Cajones reforzados

87SQ3410BABK	Características		Dimensiones L x P x H (mm)		160
	Total	Total + ruedas de Ø 127 x 50.8 mm	5 cajones	2 cajones	
		1235 x 800 x 805	1235 x 800 x 994	570 x 380 x 70	
			570 x 380 x 150	654 x 376 x 205	
			389 x 406 x 202	791 x 523 x 329	
			Cajón vertical	385 x 378	

- Armario con cerradura para guardar herramientas

- Posibilidad de colgar accesorios
- Dimensiones : 435 x 501 mm

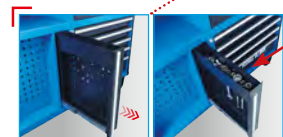

- Cajón vertical con llaves y enchufes...



- Posibilidad de colgar papelera o porta químicos

- Encimera reforzada

- Empuñadura larga

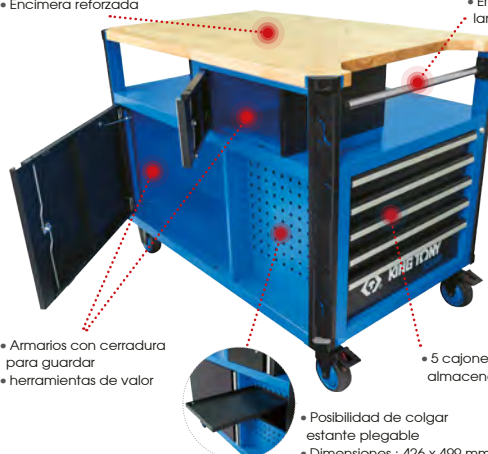

- Armarios con cerradura para guardar herramientas de valor

- 5 cajones de almacenamiento

- Posibilidad de colgar estante plegable
- Dimensiones : 426 x 499 mm

# SQUAD



**87SQ3210BABK**

1 032 €<sup>D</sup>

**CARRO PARA TALLER XL MODELO DX - 10 CAJONES**

Antigolpes	Sistema RFS*	Espesor de la chapa del cuerpo: 1 mm	Espesor de la chapa de los cajones: 0.8 mm	700 kg	Cierre centralizado con llave
35 kg	30 kg	35 kg	100% Cajones sobre correderas de bolas	570x380 mm	Cajones reforzados

87SQ3210BABK	Características		Dimensiones L x P x H (mm)	
		Total	981x473x805	
	Total + ruedas de Ø 127 x 50.8 mm	981x473x994		
	7 cajones	570x380x70		
	1 cajón	570x380x150		
	Compartimento grande	270x380x380		
	Compartimento pequeño	270x380x280		

## ACCESORIOS

# SQUAD

**87SQ341A** 23 €<sup>B</sup>

**BANDEJA PARA HERRAMIENTAS**



• Dimensiones (LxHxP) : 275x150x136 mm

1,06



**87SQ342A** 44 €<sup>B</sup>

**PAPELERA DE 25 L**



• Dimensiones (LxHxP) : 363x232x411mm

**87SQ351A** 32 €<sup>B</sup>

**PORTA PAPEL**



• Dimensiones (LxH) : 640x540 mm  
• Para rollos de papel de 280 mm de ancho

Sólo para 87SQ31\_ BAKK

**87SQ313A** 46 €<sup>B</sup>

**PANEL TRASERO**

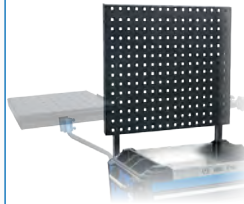

• Dimensiones (LxH) : 640x540 mm

**87SQ331A** 116 €<sup>B</sup>

**ESTANTERÍA PORTÁTIL**

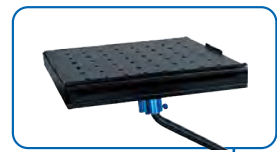

• Dimensiones (LxHxP) : 378x285x79 mm

**87SQ332A** 15 €<sup>B</sup>

**SOPORTE PARA TELÉFONO**



• Dimensiones (LxH) : 200x52 mm

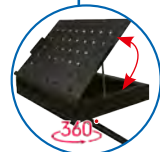

• 3 ángulos de ajuste disponibles, 20°/45°/60°

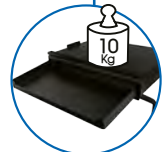

• Debajo del soporte hay un cajón para guardar papelería

**87SQ323A** 31 €<sup>B</sup>

**PORTA HERRAMIENTAS ELÉCTRICAS**

• 285x172x71 mm



**87SQ311A** 25 €<sup>B</sup>

**MONTAJE LATERAL**

• 325x683 mm

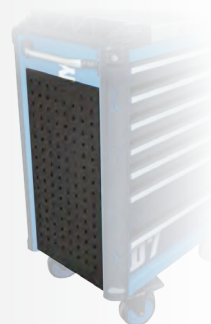

**87SQ333A** 49 €<sup>B</sup>

**ESTANTE PLEGABLE**

• 398x280x179 mm



**87SQ312A** 17 €<sup>B</sup>

**PORTA DOCUMENTOS**

• 325x260x34 mm



**87SQ322A** 13 €<sup>B</sup>

**PORTA QUÍMICOS**

• 320x101x74 mm





**87B5108B** 679€<sup>D</sup>

**COFRE METÁLICO - 8 CAJONES CON COMPARTIMENTO SUPERIOR**



87B5108B	Características	Dimensiones (mm) L x P x H	kg
	Total	1091 x 470 x 564	
1 compartimento superior	1086 x 466 x 111.5		
2 cajones	570 x 410 x 54		
1 cajón	570 x 410 x 112		
1 cajón	570 x 410 x 170		
2 cajones	313 x 410 x 54		
1 cajón	313 x 410 x 112		
1 cajón	313 x 410 x 170		



**87B3116B** 1199€<sup>D</sup>

**BANCO DE TALLER MÓVIL - 16 CAJONES**

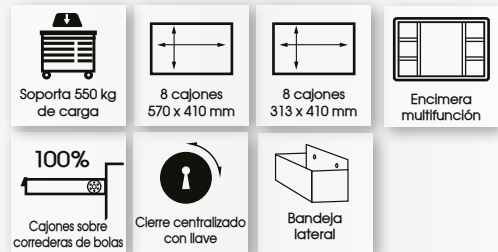

87B3116B	Características	Dimensiones (mm) L x P x H	kg
	Total	1091 x 470 x 1032	
3 cajones	570 x 410 x 54		
2 cajones	570 x 410 x 83		
2 cajones	570 x 410 x 112		
1 cajón	570 x 410 x 170		
3 cajones	313 x 410 x 54		
2 cajones	313 x 410 x 83		
2 cajones	313 x 410 x 112		
1 cajón	313 x 410 x 170		



**87B3111B** 999€<sup>D</sup>

**BANCO DE TALLER MÓVIL - 11 CAJONES**

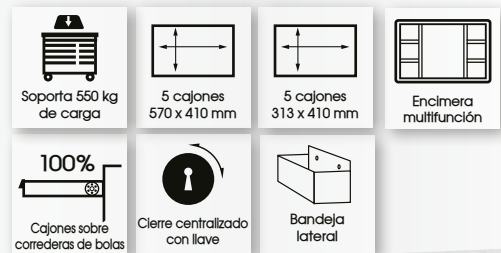

87B3111B	Características	Dimensiones (mm) L x P x H	kg
	Total	1091 x 470 x 1032	
1 cajón	937 x 410 x 130		
1 cajón	570 x 410 x 54		
3 cajones	570 x 410 x 112		
1 cajón	570 x 410 x 170		
1 cajón	313 x 410 x 54		
3 cajones	313 x 410 x 112		
1 cajón	313 x 410 x 170		

87512

1759€<sup>D</sup>

**MESA DE TALLER CON 1 ARMARIO DE PUERTAS CORREDERAS Y 3 CAJONES**



**PRO**  
series



	Características	Dimensiones (mm) L x P x H	
87512	Total	1565 x 766 x 1403	130.1
	Cofre 3 cajones	668 x 313 x 270	
	2 cajones	568 x 262 x 50	
	1 cajón	568 x 262 x 75	
	Armario	1565 x 203 x 603	

87502

1019€<sup>D</sup>

**MESA DE TALLER CON 1 PANEL PERFORADO, 2 ARMARIOS Y 3 CAJONES**



**STRENGTH**  
series



	Características	Dimensiones (mm) L x P x H	
87502	Total	1525 x 700 x 1520	86
	Cofre 3 cajones	660 x 307 x 251	
	2 cajones	569 x 275 x 50	
	1 cajón	569 x 275 x 75	
	Armario	400 x 200 x 500	

87502P011

**STRENGTH**  
series

465€<sup>D</sup>

**MESA DE TALLER**



	Características	Dimensiones (mm) L x P x H	
87502P011	Total	1525 x 700 x 800	48

87504

**STRENGTH**  
series

599€<sup>D</sup>

**MESA DE TALLER CON RUEDAS**



	Características	Dimensiones (mm) L x P x H	
87504	Total	1525 x 700 x 910	66

87502P91

**STRENGTH**  
series

675€<sup>D</sup>

**COFRE 3 CAJONES PARA MESA DE TALLER**



	Características	Dimensiones (mm) L x P x H	
87502P91	Total	1525 x 700 x 1520	61
	Cofre 3 cajones	660 x 307 x 251	
	2 cajones	569 x 275 x 50	
	1 cajón	569 x 275 x 75	

87502P02

**STRENGTH**  
series

209€<sup>D</sup>

**COFRE 3 CAJONES PARA MESA DE TALLER**

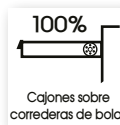

	Características	Dimensiones (mm) L x P x H	
87502P02	Cofre 3 cajones	660 x 307 x 251	12
	2 cajones	569 x 275 x 50	
	1 cajón	569 x 275 x 75	

Oferta válida del 01/01/2025 al 31/12/2025. Precio recomendado de venta al público en euros sin IVA. Fotos no contractuales.

# UN MUEBLE A MEDIDA

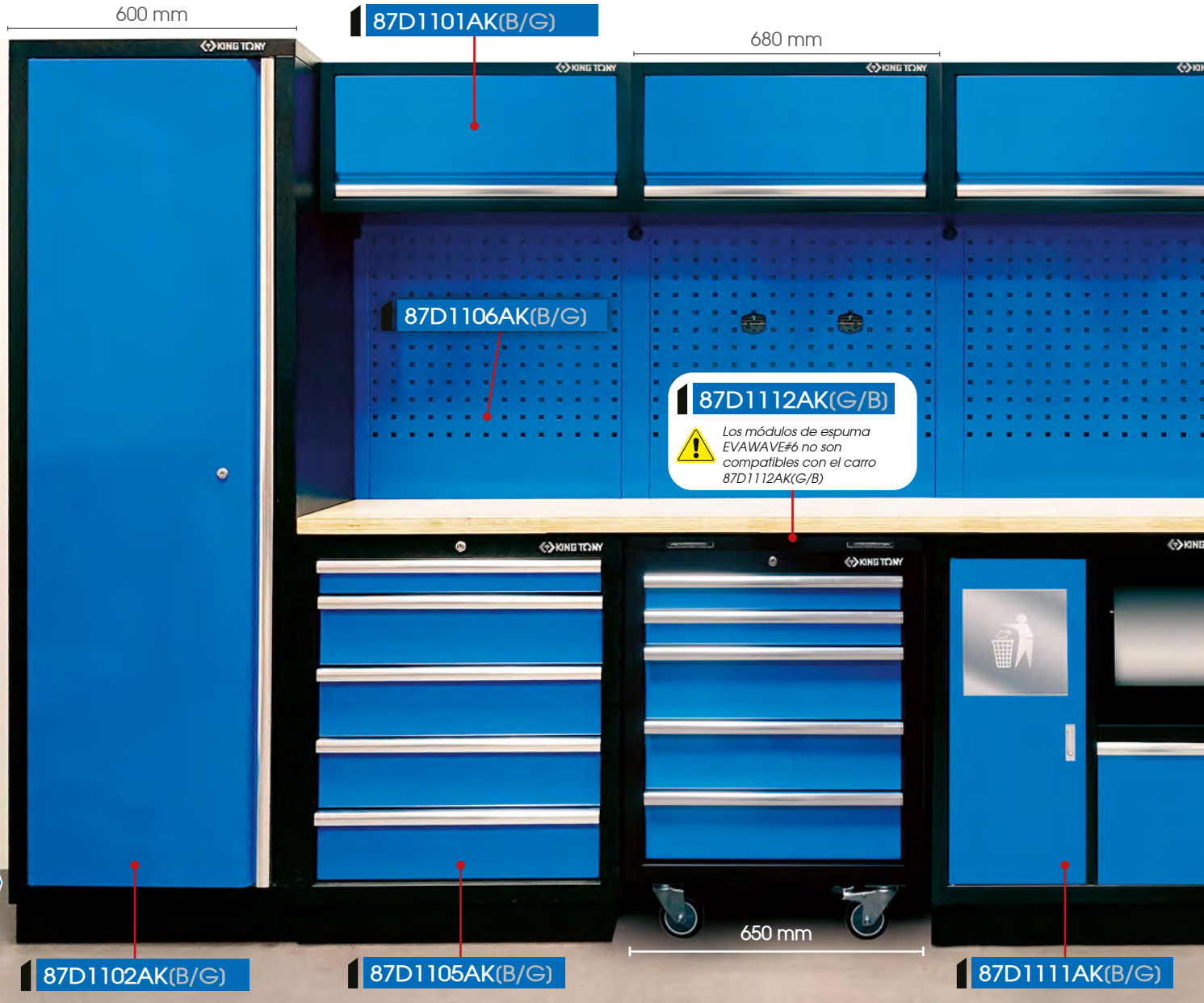

Existe en 2 colores

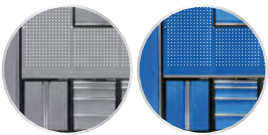

87D11AK(G/B) 3217€<sup>D</sup>

87D11AK(G/B)S 3349€<sup>D</sup>



87D11AK(G/B)U 3358€<sup>D</sup>

87D11AK(G/B)US 3490€<sup>D</sup>



87D11AK(G/B)T 2062€<sup>D</sup>

87D11AK(G/B)TS 2114€<sup>D</sup>



87D11AK(G/B)L 1549€<sup>D</sup>

87D11AK(G/B)LS 1617€<sup>D</sup>

Oferta válida del 01/01/2025 al 31/12/2025. Precio recomendado de venta al público en euros sin IVA. Fotos no contractuales.





(G)

(B)

87D1115AK(G/B) 247€<sup>D</sup>

87D1116AK(G/B) 73€<sup>D</sup>

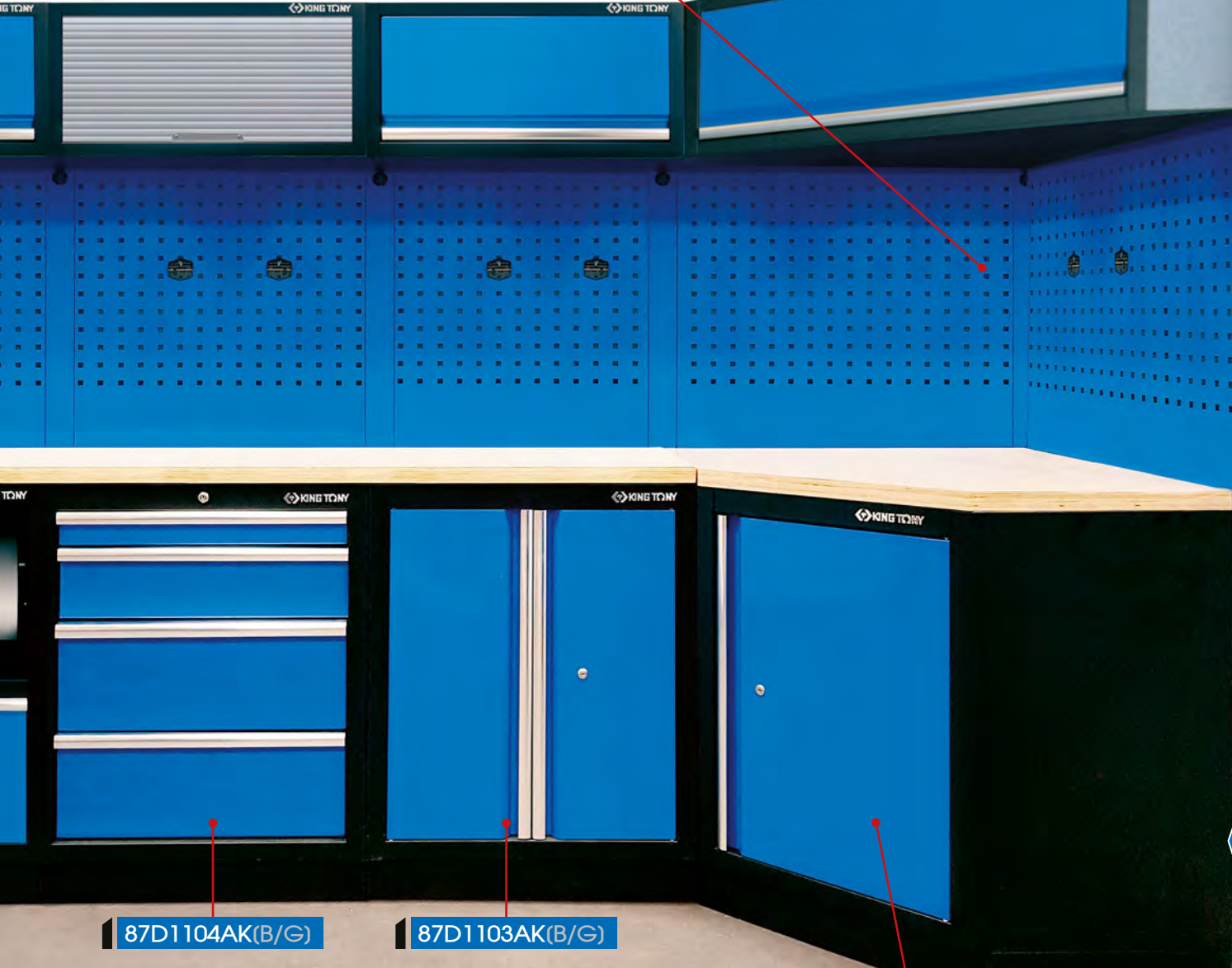

87D1104AK(B/G)

87D1103AK(B/G)

87D1113AK(G/B) 417€<sup>D</sup>



87D1119AK(G/B)

715€<sup>D</sup>

UNIDAD BASE DEL FREGADERO

33



680 mm

Grifo y fregadero de acero inoxidable, fácil de limpiar.



680 x 464 x 948 mm

**New**



Disponible en mayo



800

3 PZAS

9TE6403

31€<sup>B</sup>

**JUEGO DE BANDEJAS MAGNETICAS PLEGABLES**

La bandeja magnética para piezas de recambio está disponible en 3 tamaños para adaptarse a todas las necesidades. Dispone de una base magnética para sujetar varias piezas mientras trabaja. Fabricado con silicona blanda, aumenta la fricción y evita que se rayen las superficies de los objetos.



Si se monta con paneles perforados, se necesitan 2 medios separadores de esquina 87D11071AK(B/G)

Para muebles de esquina :

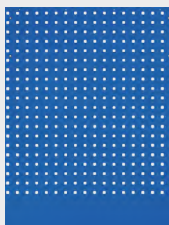

87D1116AK(G/B)

798 x 24 x 1052 mm

864 mm

864 mm

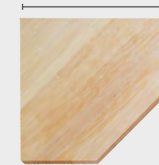

87D1114A

149€<sup>D</sup>



87D1114SA

225€<sup>D</sup>

Oferta válida del 01/01/2025 al 31/12/2025. Precio recomendado de venta al público en euros sin IVA. Fotos no contractuales.



# UN MUEBLE A MEDIDA



**87D11AK(G/B)V** 1 375 € <sup>D</sup>

**MOBILIARIO PARA TALLER COMPLETO**

Características	Dimensiones L x P x H (mm)		kg
	Total		
1 cajón	1 360 x 490 x 2000	112	
5 cajones	1 272 x 403 x 84		
1 cajón	783 x 403 x 58		
1 cajón	783 x 403 x 137		
2 puertas	284 x 371 x 531		

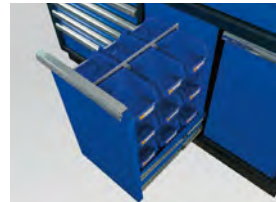

• Cajas de almacenamiento

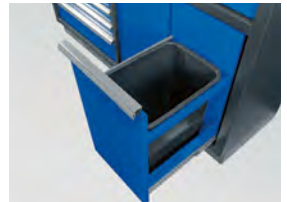

• Papelera



• Mecanismo de seguridad

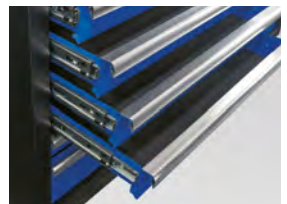

• Cajones sobre correderas de bolas

## ESTANTES DE ALMACENAMIENTO

**87D1120LAK** 335 € <sup>D</sup>

**New**

**87D1120AK** 255 € <sup>D</sup>

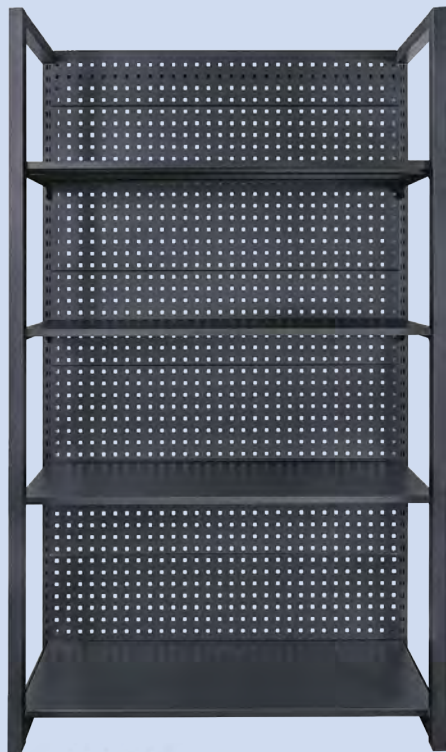

Ideal para el sistema de armario de herramientas 87D11



	Dimensiones L x P x H (mm)	kg
87D1120LAK	680 x 458 x 2000	41
87D1120AK	1200 x 458 x 2000	55

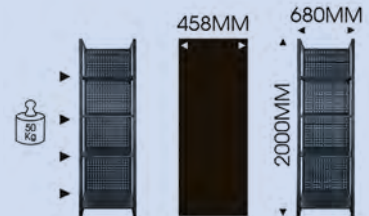

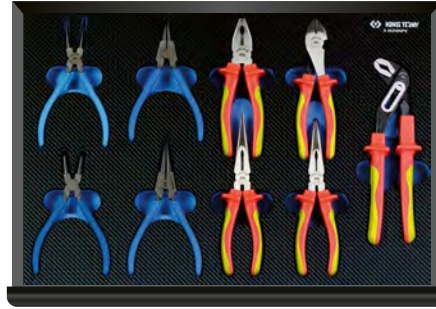
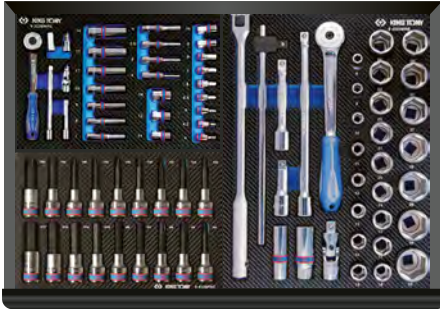

Contiene

22.9

- 2335M 4, 4.5, 5, 5.5, 6, 7, 8, 9, 10, 11, 13, 14
- 2235M 4, 5, 5.5, 6, 7, 8, 9, 10, 11, 13, 14
- 275555G 222102, 222104
- 2142 2813 2792
- 4335M 8, 9, 10, 11, 12, 13, 14, 15, 16, 17, 18, 19, 20, 21, 22, 23, 24, 25, 26, 27, 28, 29, 30, 32
- 4635 16, 20, 28
- 475510G 457212
- 445215F 4791
- 425103, 425105, 425110

- 4033 T20, T25, T27, T30, T40, T45, T50, T55, T60
- 4035 H4, H5, H6, H7, H8, H10, H12, H14, H17
- 68HB07 68HS07
- 68SS07 68SB07
- 633608A 631808A
- 651610A 611607A
- 623607A

- 1421 PH0 x 60
- 1422 3x75, 4x100, 5.5x125, 6.5x150, 8x175
- 1427 T10H x 75, T15H x 75, T20H x 100, T25H x 100, T27H x 100, T30H x 125, T40H x 150
- 1428 PZ1x100, PZ3x150
- 762G 22
- 764G ø4, ø5, ø6

3 bandejas (+) 2 a elegir

+ 58 HERRAMIENTAS = COMPOSICIÓN 166 HERRAMIENTAS

+ 49 HERRAMIENTAS = COMPOSICIÓN 157 HERRAMIENTAS

934016MED4

919€<sup>D</sup>



Contiene

- 1062 6, 7, 8, 9, 10, 11, 12, 13, 14, 15, 16, 17, 18, 19, 20, 21, 22, 23, 24, 25, 26, 27, 28, 29, 30, 32



Contiene

- 1900 6x7, 8x9, 10x11, 12x13, 14x15, 16x17, 18x19, 20x22, 21x23, 24x27, 25x28, 30x32
- 1120MR H1.5, H2, H2.5, H3, H4, H5, H6, H8, H10
- 1147R T10H, T15H, T20H, T25H, T27H, T30H, T40H, T45H, T50H
- 3204 781140OS

934016MED5

909€<sup>D</sup>



Contiene

- 1062 8, 9, 10, 11, 12, 13, 14, 15, 16, 17, 18, 19, 22, 24, 27, 29, 30, 32

- 1080 8, 9, 10, 11, 12, 13, 14, 16, 17, 18, 19



Contiene

- 1130M H1.5, H2, H2.5, H3, H4, H5, H6, H8, H10
- 1127R T10H, T15H, T20H, T25H, T27H, T30H, T40H, T45H, T50H
- 601110R 782180OS

\*Garantía ilimitada en el tiempo, salvo herramientas de golpe y puntas 1/4".

Oferta válida del 01/01/2025 al 31/12/2025. Precio recomendado de venta al público en euros sin IVA. Fotos no contractuales.



# COMPOSICIÓN 360 HERRAMIENTAS

**New**



recomendado con

**SQUAD D7+**  
(87SQ337BARK)



**GARANTÍA ILIMITADA\***



9SQL001MD

**New**



Disponible en marzo

1/4"

3/8"

1/2"

2534 €<sup>D</sup>

43.29

Contiene

4230M	8, 9, 10, 11, 12, 13, 14, 15, 16, 17, 18, 19, 21, 22, 24, 27, 30, 32, 33, 34, 36	1421	PH0 x 60, PH2 x 38	75260	770225
4335M	8, 9, 10, 11, 12, 13, 14, 15, 16, 17, 18, 19, 20, 21, 22, 23, 24, 25, 26, 27, 28, 29, 30, 32, 33, 36	1422	3 x 75, 6.5 x 38	2792	2142
4375M	E10, E12, E14, E16, E18, E20, E22, E24	1461	PH2 x 100, PH3 x 150	2813	
4025	H6, H7, H8, H10, H12, H14, H17	1462	6.5 x 100, 8 x 150	373A	8, 9, 10, 11, 12, 13, 14, 15, 16, 17, 18, 19, 22, 24
4023	T20, T25, T27, T30, T40, T45, T50, T55, T60, T70	1427	T8H x 75, T10H x 75, T15H x 75, T20H x 100, T25H x 100, T27H x 100, T30H x 125	1836S	9 x 1.6, 11 x 2
4026	M5, M8, M10, M12, M14	1421 extra largo	PH2 x 300	1880S	8 x 1.2, 10 x 1.6
4027	T30, T40, T45, T50, T55, T60	1422 extra largo	6.5 x 300	1836P	PH2, PH3
4035	H6, H7, H8, H10	43280212		1880P	PH2, PH3
4033	T40, T45, T50, T55, T60, T70	7711106A		1832H	H3, H4, H5, H6, H7, H8, H10, H12
4036	M8, M10, M12	7909405M		1832T	T15, T20, T25, T27, T30, T40, T45, T50
402B	M16	793204		1636H	H5, H6, H7, H8, H10, H12
477310GS	445318F	74408		1636T	T30, T40, T45, T50, T55, T60
414808S, 414810S, 414810M	4791	2335M	3, 2, 4, 5, 5.5, 6, 7, 8, 9, 10, 11, 12, 13, 14	1636M	M6, M8, M10, M12
429305, 429310		2235M	4, 4.5, 5, 5.5, 6, 7, 8, 9, 10, 11, 12, 13, 14	414810M	
4435M	10, 11, 12, 13, 14, 15, 16, 17, 18, 19, 21, 22, 24, 27, 30, 32, 33, 34, 36	1025P	PH1, PH2, PH3	414810S	4112
651710C	623107	1025S	3, 4, 5, 6	1900	8x9, 10x11, 12x13, 14x15, 16x17, 18x19, 20x22, 21x23, 24x27, 30x32
631108	611209	1025H	H3, H4, H5, H6	1062	6, 7, 8, 9, 10, 11, 12, 13, 14, 15, 16, 17, 18, 19, 20, 21, 22, 23, 24, 27, 30, 32
68HB07	68HS07	1025Z	P21, P22, P23	1930	8x10, 10x12, 11x13, 12x14, 17x19, 19x22
68HS10	68SS10	1025T	T10, T15, T20, T25, T27, T30, T40	762G	18, 22
68SB07	68SS07	1025U	T10H, T15H, T20H, T25H, T27H, T30H, T40H	9TK108, 9TK112	
68SS10	68SS10	477310GS		784310	
672010	601110N	2133NU		786238	
		2178DF		1147R	T10H, T15H, T20H, T25H, T27H, T30H, T40H, T45H, T50H
				1120MR	1.5, 2, 2.5, 3, 4, 5, 6, 8, 10
				36111R	
				320670	
				9TK112	
				764G	Ø 2, Ø 3, Ø 4, Ø 5, Ø 6, Ø 8, Ø 10, Ø 12, Ø 14

\*Garantía ilimitada en el tiempo, salvo herramientas de golpe, herramientas de corte y puntas 1/4".

Oferta válida del 01/01/2025 al 31/12/2025. Precio recomendado de venta al público en euros sin IVA. Fotos no contractuales.

# COMPOSICIÓN 385 HERRAMIENTAS



recomendado con

**SQUAD D7+**  
(87SQ337BABK)



**GARANTÍA ILIMITADA\***



## 9G33001MD1

1/4"

3/8"

1/2"

2279€<sup>D</sup>

50,00

Contiene

	2335M	5.5, 6, 7, 8, 9, 10, 11, 12, 13, 14		1062	6, 8, 10, 11, 13, 14, 16, 17, 18, 19, 21, 22, 24, 27, 30, 32		1970	6x7, 8x9, 10x11, 12x13, 14x15, 16x17, 18x19, 20x22, 24x27, 30x32
	4335M	10, 11, 12, 13, 14, 15, 16, 17, 18, 19, 21, 22, 23, 24, 27, 30, 32		3732M	6x7, 8x9, 10x11, 12x13, 14x15, 16x17, 18x19, 20x22, 21x23, 24x27, 25x28, 30x32		1930	8x10, 10x12, 11x13, 12x14, 17x19, 19x22
	4235M	8, 9, 10, 11, 12, 13, 14, 15, 16, 17, 18, 19		1025S	3.0, 4.0, 5.0, 6.0		1421	PH0 x 60, PH2 x 38
	3375M	E8		1025P	PH1, PH2 x 2, PH3		1422	3 x 75, 6.5 x 38
	4375M	E10, E12, E14, E16, E18, E20, E22, E24		1025Z	PZ1, PZ2 x 2, PZ3		1461	PH2 x 100, PH3 x 150
	4033	T55, T70		1025T	T10, T15, T20, T25, T27, T30, T40		1462	6.5 x 100, 8 x 150
	4049	M7, M8, M9, M10, M12, M13, M14, M16		1025H	H3, H4, H5, H6		1427	T8Hx75, T10Hx75, T15Hx75, T20Hx100, T25Hx100, T27Hx100, T30Hx125
	4036	M6, M8, M10, M12		1025U	T10H, T15H, T20H, T25H, T27H, T30H, T40H		1421 extra largo	PH2 x 300
	4035	H6, H8, H10, H12		1025R			1422 extra largo	6.5 x 300
	4026	M14, M16, M18		1636H	H5, H6, H7, H8, H10, H12		43280212	212118
	1025H	H3, H4, H5, H6		1636M	M6, M8, M10, M12		7711106A	7734020
	1025U	T10H, T15H, T20H, T25H, T27H, T30H, T40H		1636T	T30, T40, T45, T50, T55, T60		7909405M	9DC23
	1025Z	PZ1, PZ2		1832H	H3, H4, H5, H6, H7, H8, H10, H12		793204	797107
	275555G	475510G		1832T	T15, T20, T25, T27, T30, T40, T45, T50		74408	
	257145	2178DF		1836P	PH2, PH3		66HS07	66HB07
	2142	222102, 222104		1836S	9 x 1.6, 11 x 2		66SS07	66SB07
	425105, 425110	2792		1880P	PH2, PH3		611107	631106
	4791	2813, 4813		1880S	8 x 1.2, 10 x 1.6		621106	651710C
	3335M	6, 7, 8, 9, 10, 11, 12, 13, 14, 15, 16, 17, 18, 19, 21, 22, 24		414810M	4112		785116	784310
	377108G	345308F		414810S			786238	782027
	329303, 329306	377108G, 3792		75363	770225, 7732826		764G	Ø 2, Ø 3, Ø 4, Ø 5, Ø 6, Ø 8, Ø 10, Ø 12, Ø 14
	4435M	10, 11, 12, 13, 14, 15, 16, 17, 18, 19, 21, 22, 24, 27, 30, 32, 33, 34, 36		276A04G	361106R, 361108R		762G	18, 22, 9TK108, 9TK112
	4945MX	17, 19, 21		10D0	10, 12, 13, 14, 17, 18, 19			
	7713308	6AB3175		1130MR	H2.5, H3, H4, H5, H6, H8, H10			
	9AE32110 (Ø65-120)			1130SR	3/32", 1/8", 5/32", 3/16", 1/4", 5/16", 3/8"			
	9AE43	34440A, 159609		1147R	T10H, T15H, T20H, T25H, T27H, T30H, T40H			
	344231A (42-100 Nm)	158609		1120MR	H1.5, H2, H2.5, H3, H4, H5, H6, H7, H8			
				1143R	T10, T15, T20, T25, T27, T30, T40, T45, T50			

\*Garantía ilimitada en el tiempo, salvo herramientas de golpe, herramientas de corte y puntas 1/4".

Oferta válida del 01/01/2025 al 31/12/2025. Precio recomendado de venta al público en euros sin IVA. Fotos no contractuales.

# COMPOSICIÓN 263 HERRAMIENTAS

GARANTÍA ILIMITADA\*



934263MRED

1/4"

1/2"

1/4" + 1/2"

1719€

Contiene

	2335M	4, 4.5, 5, 5.5, 6, 7, 8, 9, 10, 11, 12, 13
	2375M	4, 5, 6, 7, 8
	275555G	
	257145	
	245205F	
	222102, 222104	
	2792	
	2177DF	
	2142	4112
	1025P	PH1, PH2, PH3
	1025Z	PZ1, PZ2, PZ3
	1025H	3, 4, 5, 6
	1025U	T7H, T8H, T9H, T10H, T15H, T20H, T25H, T27H, T30H, T40H
	1832H	H3, H4, H5, H6, H7, H8, H10, H12
	1832T	T15, T20, T25, T27, T30, T40, T45, T50
	1636H	H5, H6, H7, H8, H10, H12
	1636T	T30, T40, T45, T50, T55, T60
	1636M	M6, M8, M10, M12
	1836S	11 x 2.0, 9 x 1.6
	1836P	PH2, PH3
	1061	6, 7, 8, 9, 10, 11, 12, 13, 14, 15, 16, 17, 18, 19, 20, 21, 22, 23, 24, 25, 26, 27, 28, 29, 30, 32
	1147R	T10, T15, T20, T25, T27, T30, T40, T45, T50
	1120MR	H1.5, H2, H2.5, H3, H4, H5, H6, H8, H10

	4335M	8, 9, 10, 11, 12, 13, 14, 15, 16, 17, 18, 19, 20, 21, 22, 23, 24, 25, 26, 27, 28, 29, 30, 32, 33, 36
	4375M	E10, E12, E14, E16, E18, E20, E22, E24
	402B	M16
	4025	H6, H7, H8, H10, H12, H14 H17
	4023	T20, T25, T27, T30, T40, T45, T50, T55, T60, T70
	4026	M14, M12, M10, M8, M5
	4027	T30, T40, T45, T50, T55, T60
	4035	H6, H7, H8, H10
	4036	M8, M10, M12
	4033	T40, T45, T50, T55, T60, T70
	4148	414810M (10 mm), 414810S (5/16"), 414808S (1/4")
	477310GS	
	445318F	
	429305, 429310	
	4791	
	1461	PH2 x 75, PH2 x 100, PH3 x 150
	1421	PH2 x 38
	1462	5.5 x 100, 6.5 x 150, 8.0 x 175
	1422	6.5 x 38, 3 x 75, 4x 100, 10.0 x 200, 12 x 250
	2121A18	

	361115			320670
	9TK112			672110
	6CB21			7951212
	9DC22			7734020
	7713106			7906320
	7909405M			797107
	792112			6AB3175
	651710C			782180OS
	7640306G, 7640407G, 7640508G, 7640684G, 7640888G, 7641009G, 7641210G, 7641411G			7622284G
	7610474G, 7610674G, 7610874G, 7611074G, 7612574G			7622610GR
	7822284G			784315
	786238			66HS07
	66HS07			66SB07
	66HB07			66SS07
	611107			621106
	631106			

\*Garantía ilimitada, salvo herramientas de golpe, de medida, eléctricas, herramientas de corte y puntas 1/4".

Oferta válida del 01/01/2025 al 31/12/2025. Precio recomendado de venta al público en euros sin IVA. Fotos no contractuales.

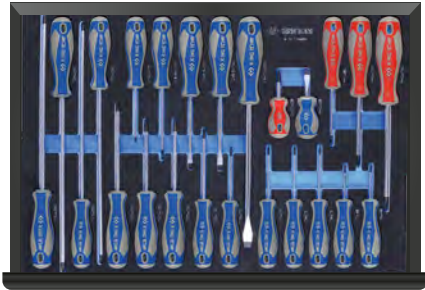

934A011MRVD01

1/4"

3/8"

1/2"

1/4" + 3/8" + 1/2"

1 399€<sup>D</sup>

Contiene

33.35

○	2335M	4, 4.5, 5, 5.5, 6, 7, 8, 9, 10, 11, 12, 13, 14
○	2235M	4, 4.5, 5, 5.5, 6, 7, 8, 9, 10, 11, 12, 13, 14
★	2375M	E4, E5, E6, E7, E8
★	2013X	T8, T9, T10, T15, T20, T25, T27, T30, T40
●	2015MX	H3, H4, H5, H6, H8
⊗	2018X	P21, P22
⊕	2011X	PH1, PH2
⊖	2012X	3.5, 5.5, 8
★	1025T	T6, T7
●	1025M	M4, M5, M6, M8, M10
○	2792	2813
○	276A04G	
○	222102, 222104, 222106	
○	3335M	10, 11, 12, 13, 14, 15, 16, 17, 18, 19, 20, 21, 22
★	3375M	E7, E8, E10, E11, E12
○	3230M	8, 10, 11, 12, 13, 14, 16, 17, 19
○	3750M	10, 11, 12, 13, 14, 15, 16, 17, 18, 19
○	3812, 3814	377908G
○	322314	
○	322103, 322106, 322110	
○	4335M	8, 10, 11, 12, 13, 14, 15, 16, 17, 18, 19, 20, 21, 22, 23, 24, 26, 27, 28, 30, 32
★	4375M	E10, E12, E14, E16, E18, E20, E22, E24
○	463516R, 463521R	
○	463014RC	
○	4791	477910G
○	429302	425105, 425110

●	1636H	H5, H6, H7, H8, H10, H12
●	1636M	M6, M8, M10, M12
★	1636T	T30, T40, T45, T50, T55, T60
●	1832H	H3, H4, H5, H6, H7, H8, H10, H12
★	1832T	T15, T20, T25, T27, T30, T40, T45, T50
⊕	1836P	PH2, PH3
⊖	1836S	9 x 1.6, 11 x 2
⊕	1880P	PH2, PH3
⊖	1880S	8 x 1.2, 10 x 1.6
○	414810M, 414810S	4112
○	1062	6, 7, 8, 9, 10, 11, 12, 13, 14, 15, 16, 17, 18, 19, 21, 22, 24, 27, 30, 32
○	1900	6x7, 8x9, 10x11, 12x13, 14x15, 16x17, 18x19, 20x22, 21x23, 24x27, 25x28, 30x32
○	1970	6x7, 8x9, 10x11, 12x13, 14x15, 16x17, 18x19, 20x22, 24x27, 30x32
★	1143	T10, T15, T20, T25, T27, T30, T40, T45, T50
○	1930	8x10, 10x12, 11x13, 12x14, 17x19, 19x22
●	1120MR	H1.5, H2, H2.5, H3, H4, H5, H6, H8, H10
⊕	1421	PH2x38, PH1x80, PH2x100, PH3x150
⊖	1422	3x75, 4x100, 5.5x100, 6.5x100, 10x200, 6.5x38
★	1423	T6x48, T7x48, T8x75, T9x75, T10x75, T15x75, T15x250, T20x100, T20x250, T25x100, T25x250, T27x100, T30x125, T30x250

⊕	PH2x300	
⊖	6.5x300	
●	1160MR	H2, H2.5, H3, H4, H5, H6, H8, H10
○	115H	8, 10, 13
○	115345R	9C2101
○	48280180	43280212
○	43240115V	7540208G
○	7510208G	7550208G
○	7520208G	7530208G
○	611106	623107
○	631108	631911C
○	601110R	631405
○	651610C	
○	67HS07	68SB07
○	67HB07	68SS07
○	7610405	
○	7621706, 7622007	
○	7640305, 7640406, 7640565, 7640607	
○	782130	
○	9DC23	212118
○	796204	796304

\*Garantía ilimitada, salvo herramientas de golpe, de medida, eléctricas, extractores, cepillo metálico, limas y puntas 1/4".

Oferta válida del 01/01/2025 al 31/12/2025. Precio recomendado de venta al público en euros sin IVA. Fotos no contractuales.



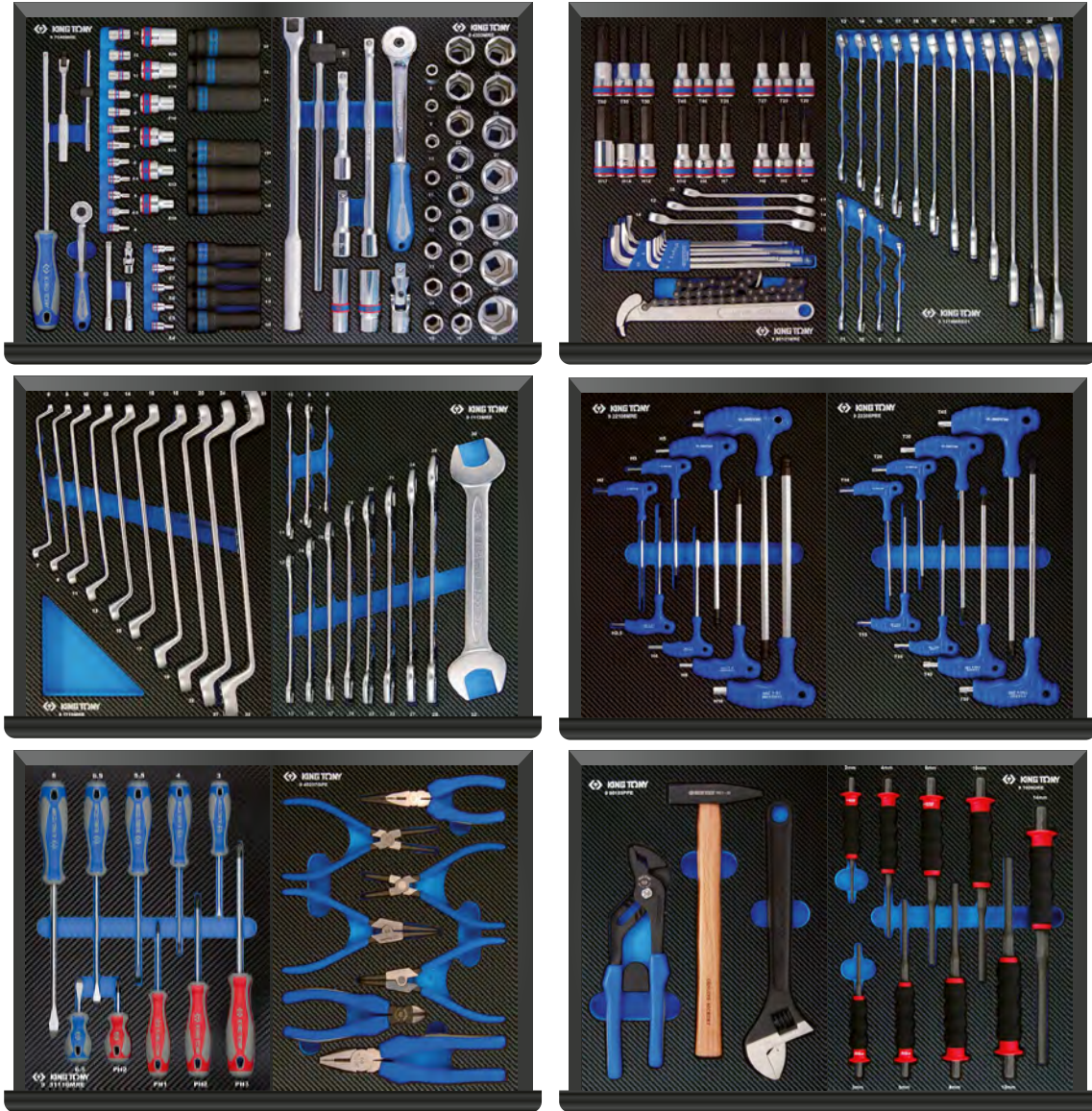

932187MED1 1/4" 1/2" 1/4" + 1/2" 1199€<sup>D</sup>

Contiene

28.84

		2335M	4, 4.5, 5, 5.5, 6, 7, 8, 9, 10, 11, 12, 13		4033	T20, T25, T27, T30, T40, T45, T50, T55, T60		1062	6, 8, 10, 11, 13, 14, 16, 17, 18, 19, 21, 22, 24, 27, 30, 32
		2375M	E4, E5, E6, E7, E8		4035	H4, H5, H6, H7, H8, H10, H12, H14, H17		1900	6x7, 8x9, 10x11, 12x13, 14x15, 16x17, 18x19, 20x22, 21x23, 24x27, 25x28, 30x32
		4375M	E10, E12, E14, E16, E18, E20		1120MR	H1.5, H2, H2.5, H3, H4, H5, H6, H8, H10		1970	6x7, 8x9, 10x11, 12x13, 14x15, 16x17, 18x19, 20x22, 24x27, 30x32
		4435M	10, 11, 12, 13, 14, 17, 19, 21, 22, 24		1930	10x11, 12x14, 14x17		1421	PH1 x 80, PH2 x 38, PH2 x 100, PH3 x 150
		275555G			3204			1422	3 x 75, 4 x 100, 5.5 x 125, 6.5 x 38, 6.5 x 150, 8 x 175
		21777NU			621106			361112P	
		257145			631106			7821300S	
		245205F			68HS07			764G	Ø 2, Ø 3, Ø 4, Ø 5, Ø 6, Ø 8, Ø 10, Ø 12, Ø 14
		4335M	8, 9, 10, 11, 12, 13, 14, 15, 16, 17, 18, 19, 20, 21, 22, 23, 24, 25, 26, 27, 28, 29, 30, 32		68HB07				
		4635	16, 20, 8		68SS07				
		475510G			1163	T10H, T15H, T20H, T25H, T30H, T40H, T45H, T50H			
		445218F			1160M	H2, H2.5, H3, H4, H5, H6, H8, H10			
		425103, 425105, 425110							

\*Garantía ilimitada en el tiempo, salvo herramientas de golpe y puntas 1/4".

Oferta válida del 01/01/2025 al 31/12/2025. Precio recomendado de venta al público en euros sin IVA. Fotos no contractuales.





**934008MED7** 1/4" + 1/2" **699€<sup>D</sup>** **934008MED8** 1/4" + 1/2" **699€<sup>D</sup>**

Contiene

17.69

2335M	5.5, 6, 7, 8, 9, 10, 11, 12, 13, 14
4335M	10, 11, 12, 13, 14, 15, 16, 17, 18, 19, 21, 22, 24, 27, 30, 32
4235M	8, 9, 10, 12, 13, 14, 15, 16, 17, 18, 19
4375M	E10, E12, E14, E16, E18
4033	T30, T40, T50, T55
4049	M8, M9, M10, M12
4036	M8, M10, M12
4035	H6, H8, H10
4026	M14
402B	M16, M18
1025H	H3, H4, H5, H6
1025U	T7H, T8H, T9H, T10H, T15H, T20H, T25H, T27H, T30H, T40H
1025Z	PZ1, PZ2, PZ3
1025P	PH1, PH2, PH3

934008MED7 →	275555G
	475510G
934008MED8 →	277155G
	477110G
257145	2178DF
213312DF	2142
222102, 222104	2792
425105R, 425110R	4791R
1062	6, 7, 8, 9, 10, 11, 12, 13, 14, 15, 16, 17, 18, 19, 20, 21, 22, 23, 24
1421	PH1 x 80, PH2 x 38, PH2 x 100, PH3 x 150
1422	3 x 75, 4 x 100, 5.5 x 125, 6.5 x 38, 6.5 x 150, 8 x 175

1120MR	H1.5, H2, H2.5, H3, H4, H5, H6, H7, H8
1147R	T10, T15, T20, T25, T27, T30, T40, T45, T50
651710C	631106
611107	621106
67HS07	67SB07
67HB07	67SS07
7610405	782130
7621706, 7622007	
7640305, 7640406, 7640565, 7640607	

\*Garantía ilimitada en el tiempo, salvo herramientas de golpe y puntas 1/4".

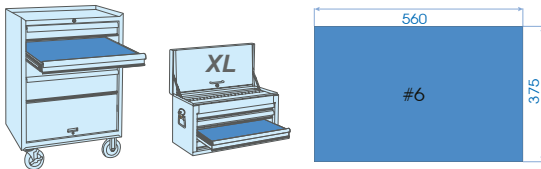

**New**

95 PZAS

**99004MRE** 1/4" 3/8" 1/2" #6 **419€<sup>B</sup>**

Contiene



2235M	4, 4.5, 5, 5.5, 6, 7, 8, 9, 10, 11, 12, 13		
3635	16, 21		
36A0	14		
2335M	4, 4.5, 5, 5.5, 6, 7, 8, 9, 10, 11, 12, 13		
3330M	10, 11, 12, 13, 14, 15, 16, 17, 18, 19		
4330M	10, 12, 13, 14, 15, 16, 17, 18, 19, 20, 21, 22, 23, 24, 27, 28, 30, 32		
4230M	10, 13, 17, 18, 19, 21, 22, 24		
3025	H3, H4, H5, H6, H8, H10, H12		
3023	T10, T15, T20, T25, T27, T30, T40, T45, T50		
277155G	377108G	477110GR	
322103, 322110	222102, 222104		
425105, 425110	4791R	2792	
3792	2813	3812	4813
446218F			

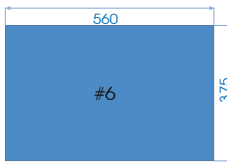
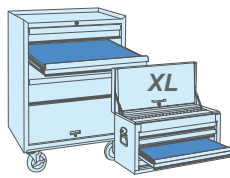

93 PZAS

**92593MRE** (1/4") **1/4" #6** **258€ B**

Contiene

2.83

	2335M	3,2, 4, 4.5, 5, 5.5, 6, 7, 8, 9, 10, 11, 12, 13, 14
	2235M	4, 4.5, 5, 5.5, 6, 7, 8, 9, 10, 11, 12, 13, 14
	2375M	E4, E5, E6, E7, E8
	2275M	E4, E5, E6, E7, E8
	2035	H3, H4, H5, H6, H7, H8, H10
	2037	T8H, T9H, T10H, T15H, T20H, T30H, T40H
	2033	T8, T9, T10, T15, T20, T25, T27, T40
	1421	PH0 x 60, PH1 x 100, PH2 x 38, PH2 x 150, PH3 x 150
	1422	3 x 75, 5.5 x 100, 6.5 x 38, 6.5 x 150, 8 x 175
	1431	PH000 x 75, PH00 x 75, PH0 x 75, PH1 x 75
	1432	1.5 x 75, 2.0 x 75, 2.5 x 75, 3.0 x 75
		PH0 / 4, PH1 / 5, PH2 / 6, PH3 / 8
		H2 / H2.5, H3 / H4, H5 / H6
		T10 / T15
	2178DF	
	32810MR	
	275555G	
	222102, 222104, 222106	
	2792	
	2142	



92 PZAS

**97392MRE** (1/4") (1/2") **#6** **419€ B**

Contiene

8.8

	2335M	5.5, 6, 7, 8, 9, 10, 11, 12, 13, 14			
	4335M	10, 11, 12, 13, 14, 15, 16, 17, 18, 19, 21, 22, 24, 27, 30, 32			
	4235M	8, 9, 10, 12, 13, 14, 15, 16, 17, 18, 19			
	4375M	E10, E12, E14, E16, E18			
	4033	T30, T40, T50, T55			
	4049	M8, M9, M10, M12			
	4036	M8, M10, M12			
	4035	H6, H8, H10			
	4026	M14			
	402B	M16, M18			
	1025H	H3, H4, H5, H6			
	1025U	T7H, T8H, T9H, T10H, T15H, T20H, T25H, T27H, T30H, T40H			
	1025Z	PZ1, PZ2, PZ3			
	1025P	PH1, PH2, PH3			
	97392MRE:	275555G	475510G		
	97392MRE01:	277155G	477110G		
		257145	2178DF	213312DF	
		222102, 222104	425105R, 425110R		
		2142	2745	2792	4791



84 PZAS

**94584MRE01** (1/2") **#6** **539€ B**

Contiene

9.7

	4335M	8, 9, 10, 11, 12, 13, 14, 15, 16, 17, 18, 19, 20, 21, 22, 23, 24, 25, 26, 27, 28, 29, 30, 32, 33, 36	
	4375M	E10, E12, E14, E16, E18, E20, E22, E24	
	4025	H6, H7, H8, H10, H12, H14, H17	
	4023	T20, T25, T27, T30, T40, T45, T50, T55, T60, T70	
	4026	M5, M8, M10, M12, M14	
	4027	T30, T40, T45, T50, T55, T60	
	4035	H6, H7, H8, H10	
	4033	T40, T45, T50, T55, T60, T70	
	4036	M8, M10, M12	414808S, 414810S, 414810M
	402B	M16	429305, 429310
	477310GS		
	445318F		
	4791		

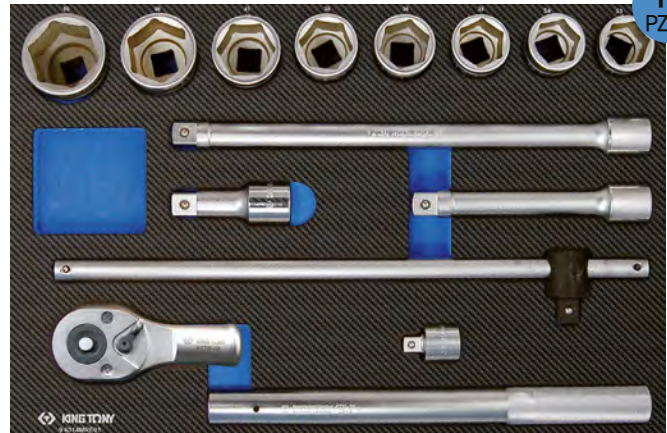

14 PZAS

**96314MRE01** (3/4") **#6** **349€ B**

Contiene

10.8

	6335M	33, 34, 35, 36, 38, 41, 46, 50
	677820FS	657220
	625104, 625108, 625116	6814

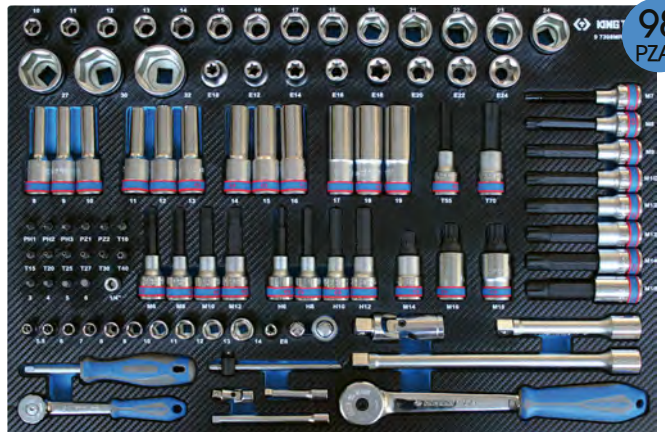
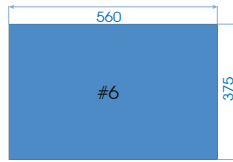
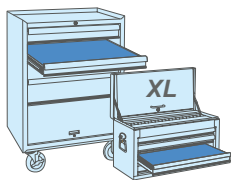

**97543MRV**  $\frac{1}{4}$ "  $\frac{1}{2}$ " #6 339€ B

Contiene 5.65

	2335M	4, 5, 5.5, 6, 7, 8, 9, 10, 11, 12, 13, 14
	4335M	10, 11, 13, 14, 15, 16, 17, 18, 19, 20, 21, 22, 24, 27, 30, 32
	1636H	H4, H5, H6, H7, H8, H10, H12
	1636M	M5, M6, M8, M10, M12
	1636T	T20, T25, T27, T30, T40, T45, T50, T55, T60
	1680H	H4, H5, H6, H7, H8, H10, H12
	1680M	M5, M6, M8, M10, M12
	1680T	T20, T25, T27, T30, T40, T45, T50, T55, T60
	1120MR	H1.5, H2, H2.5, H3, H4, H5, H6, H8, H10
	1127R	T10H, T15H, T20H, T25H, T27H, T30H, T40H, T45H, T50H
	1025H	H3, H4, H5, H6
	1025S	3.0 x 0.5, 4.0 x 0.5, 5.0 x 0.8, 6.0 x 1.0
	1025U	T10H, T15H, T20H, T25H, T27H, T30H, T40H
	1025P	PH1, PH2 x 2 $\varnothing$ 6mm, PH3
	1025T	T10, T15, T20, T25, T27, T30, T40
	1025Z	PZ1, PZ2 x 2, PZ3
	75363	770225  7909505M
	797707	797807P02  425105R
	457212	2792  2142
	222302, 222304	2178DF  4791
	477110G	277155G  414710M

**97398MRE**  $\frac{1}{4}$ "  $\frac{3}{8}$ "  $\frac{1}{2}$ " #6 452€ B

Contiene 8.8

	2335M	5.5, 6, 7, 8, 9, 10, 11, 12, 13, 14
	4335M	10, 11, 12, 13, 14, 15, 16, 17, 18, 19, 21, 22, 23, 24, 27, 30, 32
	4235M	8, 9, 10, 11, 12, 13, 14, 15, 16, 17, 18, 19
	3375M	E8
	4375M	E10, E12, E14, E16, E18, E20, E22, E24
	4033	T55, T70
	4049	M7, M8, M9, M10, M12, M13, M14, M16
	4036	M6, M8, M10, M12
	4035	H6, H8, H10, H12
	4026	M14, M16, M18
	1025H	H3, H4, H5, H6
	1025U	T10H, T15H, T20H, T25H, T27H, T30H, T40H
	1025Z	PZ1, PZ2
	275555G	475510G
	257145	2178DF  2142
	222102, 222104	425105, 425110
	2792	4791  2813  4813

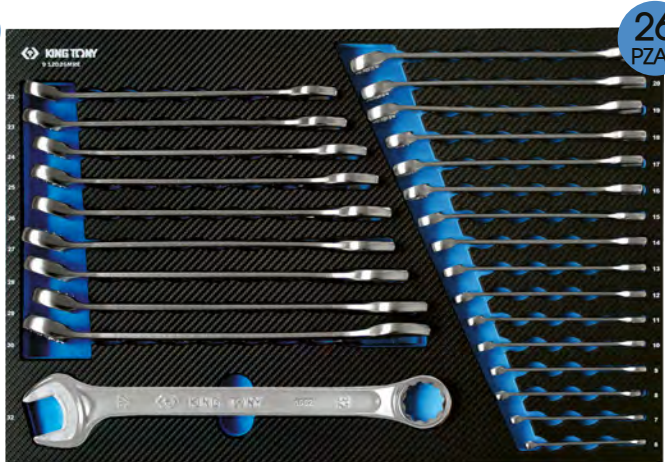

**912B6MRE** #6 333€ B

Contiene 5.9

	1061	<b>XIL</b> 6, 7, 8, 9, 10, 11, 12, 13, 14, 15, 16, 17, 18, 19, 20, 21, 22, 23, 24, 25, 26, 27, 28, 29, 30, 32
--	------	---

**912D26MRE** #6 245€ B

Contiene 5.9

	1062	6, 7, 8, 9, 10, 11, 12, 13, 14, 15, 16, 17, 18, 19, 20, 21, 22, 23, 24, 25, 26, 27, 28, 29, 30, 32
--	------	--



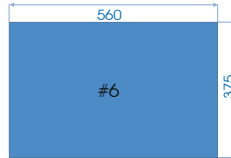
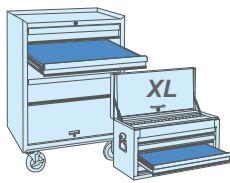

15  
PZAS

<b>991215MRV</b>		<b>#6</b>	<b>309€</b>	<b>B</b>
Contiene  2.5				
1062	27, 28, 29, 30, 32	373AM	8, 10, 11, 13, 17, 19, 22, 24	
361112R		601110R		

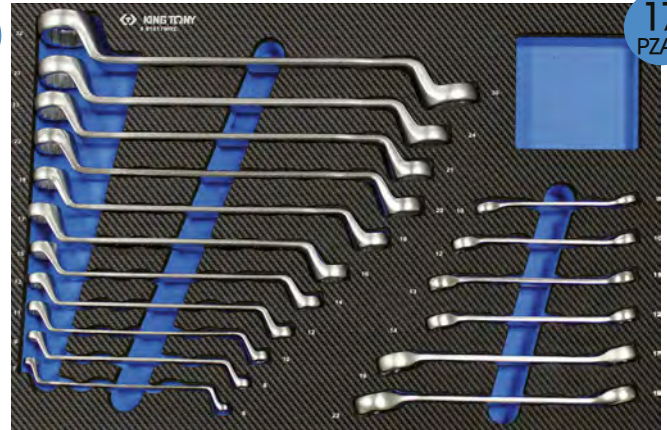

17  
PZAS

<b>991017MRE</b>		<b>#6</b>	<b>189€</b>	<b>B</b>
Contiene  3.9				
1970	6x7, 8x9, 10x11, 12x13, 14x15, 16x17, 18x19, 20x22, 21x23, 24x27, 30x32			
1930	8x10, 10x12, 11x13, 12x14, 17x19, 19x22			



23  
PZAS

<b>990223MRE2</b>		<b>#6</b>	<b>191€</b>	<b>B</b>
Contiene  3.9				
1062	8, 9, 10, 11, 12, 13, 14, 15, 16, 17, 18, 19			
1080	8, 9, 10, 11, 12, 13, 14, 16, 17, 18, 19			

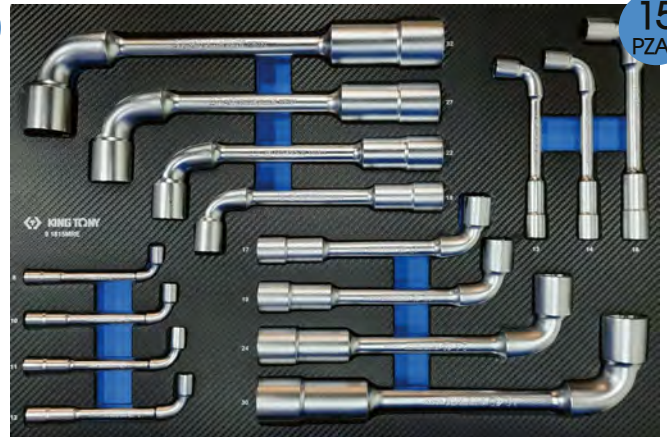

15  
PZAS

<b>91815MRE</b>		<b>#6</b>	<b>269€</b>	<b>B</b>
Contiene  7.55				
1080	8, 10, 11, 12, 13, 14, 16, 17, 18, 19, 22, 24, 27, 30, 32			



22  
PZAS

<b>991122MRV</b>		<b>#6</b>	<b>208€</b>	<b>B</b>
Contiene  3.18				
1060	8, 9, 10, 11, 12, 13, 14, 15, 16, 17, 19, 21, 22, 24			
115H	H6, H7, H8, H9, H10, H11, H12, H13			



26  
PZAS

<b>990226MRE1</b>		<b>#6</b>	<b>217€</b>	<b>B</b>
Contiene  5.5				
1062	22, 24, 27, 29, 30, 32			
1130M	H1.5, H2, H2.5, H3, H4, H5, H6, H8, H10			
1127R	T10H, T15H, T20H, T25H, T27H, T30H, T40H, T45H, T50H			
601110R	782180OS			

Oferta válida del 01/01/2025 al 31/12/2025. Precio recomendado de venta al público en euros sin IVA. Fotos no contractuales.

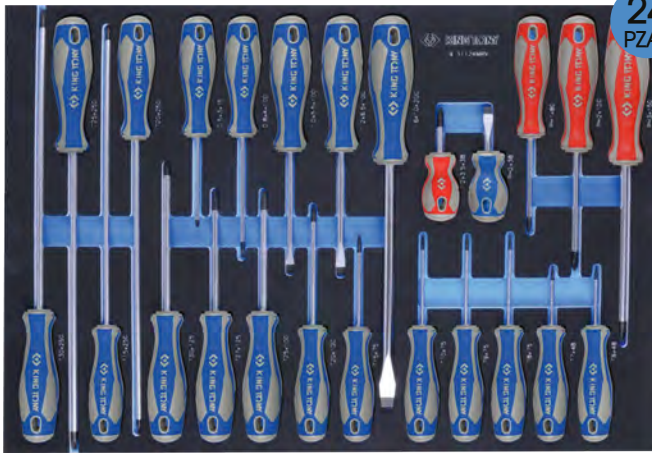
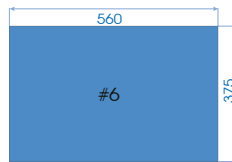
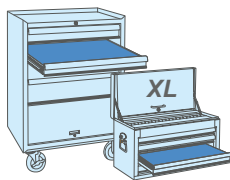

**931124MRV** #6 155€<sup>B</sup>

Contiene

2.41

	1421	PH2x38, PH1x80, PH2x100, PH3x150
	1422	3x75, 4x100, 5.5x100, 6.5x100, 10x200, 6.5x38
	1423	T6x48, T7x48, T8x75, T9x75, T10x75, T15x75, T15x250, T20x100, T20x250, T25x100, T25x250, T27x100, T30x125, T30x250



**990319PRE** #6 149€<sup>B</sup>

Contiene

2.44

	1421	PH0 x 60
	1422	3 x 75, 4 x 100, 5.5 x 125, 6.5 x 150, 8 x 175
	1427	T10H x 75, T15H x 75, T20H x 100, T25H x 100, T27H x 100, T30H x 125, T40H x 150
	1427	PZ1x100, PZ3x150
	762G	22
	764G	ø4, ø5, ø6



**990217GRE03** #6 259€<sup>B</sup>

Contiene

3.89

	764	3, 4, 5, 6
	7610506	
	7671705	
	651710C	
	601110R	
	781116	
	611108	
	623107	
	631108	
	631405	
	66SB07	
	66HB07	
	66SS07	
	66HS07	



**990217GRE04** #6 259€<sup>B</sup>

Contiene

3.89

	764	3, 4, 5, 6
	7610506	
	7671705	
	651710C	
	601110R	
	782150	
	611108	
	623107	
	631108	
	631405	
	66SB07	
	66HB07	
	66SS07	
	66HS07	

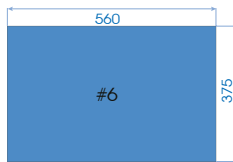
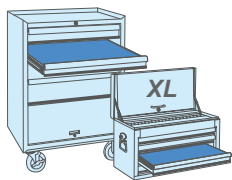

9  
PZAS

11  
PZAS

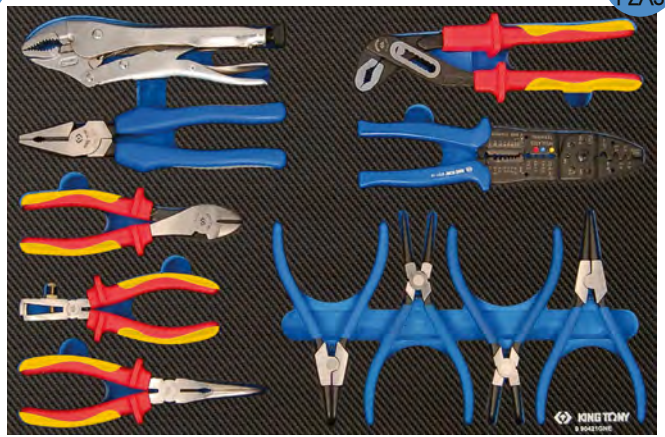
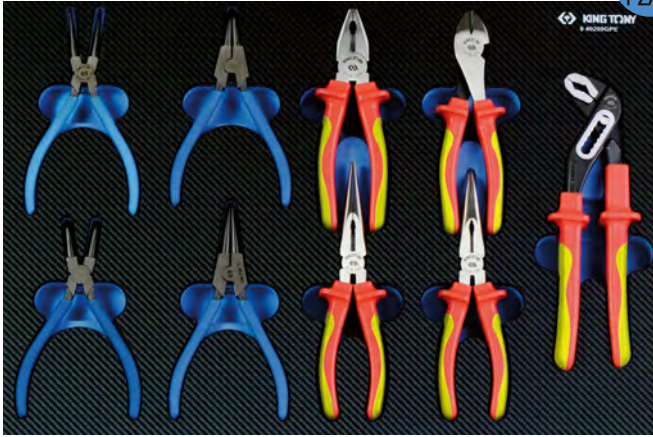

**940209GPE #6 236 € B**

**990421GNE #6 280 € B**

Contiene 2.72

Contiene 3.5

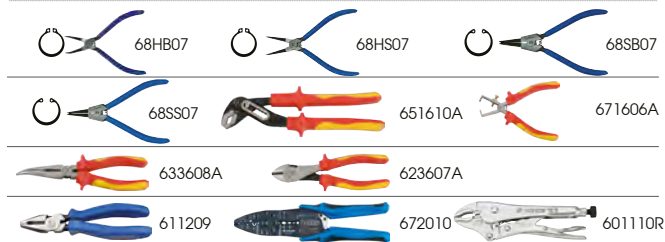
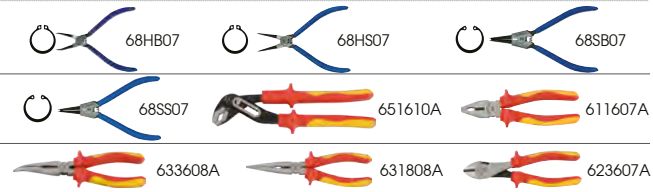

9  
PZAS

35  
PZAS



**990409TQE #6 142 € B**

**991035CRV  $\frac{1}{4}$   $\frac{1}{2}$  #6 369 € B**

Contiene 2.5

Contiene 4.47

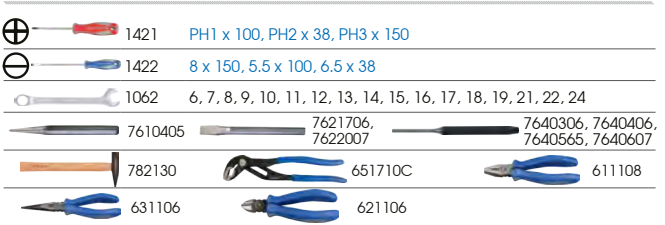
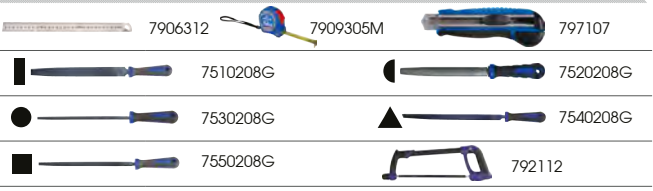

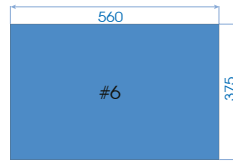
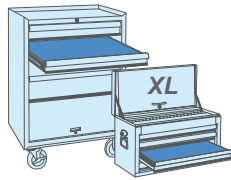

13  
PZAS

**990413TQV #6 158€<sup>B</sup>**

Contiene

2.49

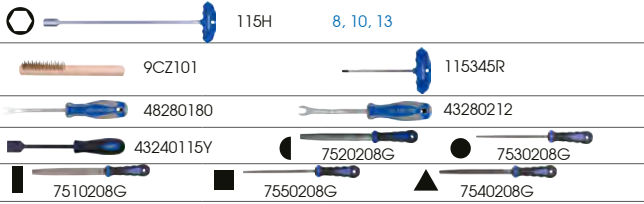

6  
PZAS

**990316TQE #6 165€<sup>B</sup>**

Contiene

1.20



8  
PZAS

**990408GQE #6 287€<sup>B</sup>**

Contiene

2.35



17  
PZAS

**91017GPE #6 269€<sup>B</sup>**

Contiene

6.5



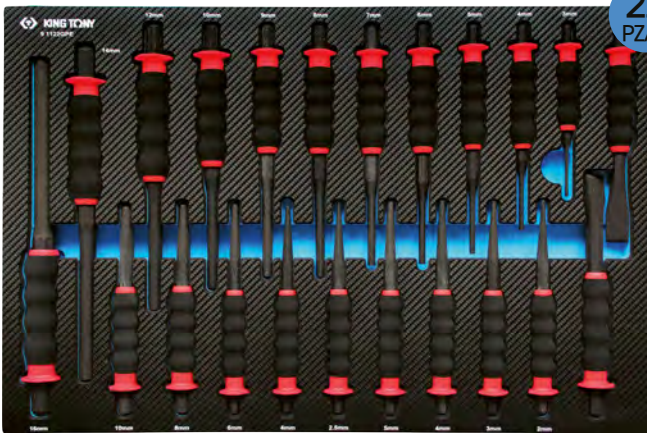
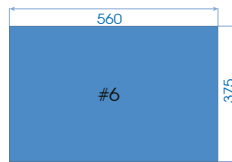
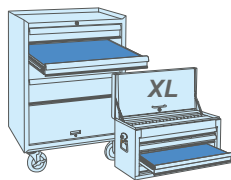

22  
PZAS

**91122GPE** #6 219€<sup>B</sup>

Contiene 4.75

	764G	ø3, ø4, ø5, ø6, ø7, ø8, ø9, ø10, ø12, ø14, ø16
	762G	18, 22
	761G	ø2,5, ø4, ø6, ø8, ø10
	763G	ø2, ø3, ø4, ø5



17  
PZAS

**991217MRV** #6 185€<sup>B</sup>

Contiene 6.11

	1421	PH1 x 80, PH2 x 100
	1422	3 x 75, 4 x 100, 5,5 x 125, 6,5 x 150, 8 x 175
	1423	T15 x 75, T20 x 100, T25 x 100, T27 x 100, T30 x 125
	48280180	9CF220
	782310, 782320	782130



11  
PZAS

**994411MQEU** #6 279€<sup>B</sup>

Contiene 4.7

	4945M	17, 19, 21
	344231A (42-100 Nm)	9AE32110
	34440A	9AE43
	7713308	
	159609	158609
	6AB3175	



41  
PZAS

**944803MPV** #6 665€<sup>B</sup>

Contiene 9.5

	4435M	10, 11, 12, 13, 14, 15, 16, 17, 18, 19, 21, 22, 24
	4535M	10, 11, 12, 13, 14, 15, 16, 17, 18, 19, 21, 22, 24, 27, 30, 32
	4945M	17, 19, 21
	4260P	426003P, 426005P
	33481095	7990010
	3341171	
	344231A	4797P
	SY211M	x2



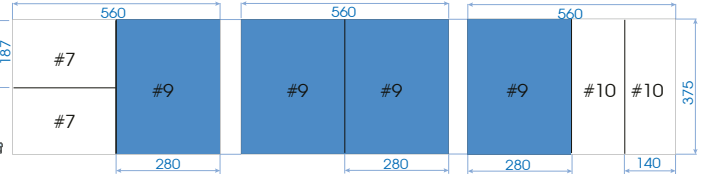
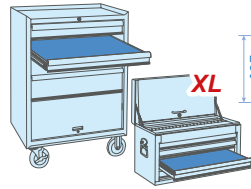
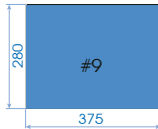

**97582MRE** (1/4") #9 151€<sup>B</sup>

Contiene 2.27

	2335M	4, 4.5, 5, 5.5, 6, 7, 8, 9, 10, 11, 12, 13
	2375M	4, 5, 6, 7, 8
	1025H	3, 4, 5, 6
	1025P	PH1, PH2, PH3
	1025U	T7H, T8H, T9H, T10H, T15H, T20H, T25H, T27H, T30H, T40H
	1025Z	PZ1, PZ2, PZ3
	1832H	H3, H4, H5, H6, H7, H8, H10, H12
	1832T	T15, T20, T25, T27, T30, T40, T50
	1636T	T30, T40, T45, T50, T55, T60
	1636H	H5, H6, H7, H8, H10, H12
	1836M	M6, M8, M10, M12
	1836S	11 x 2.0, 9 x 1.6
	1836P	PH2, PH3

275555G 257145 245205F 222102, 222104 2177DF



82 PZAS

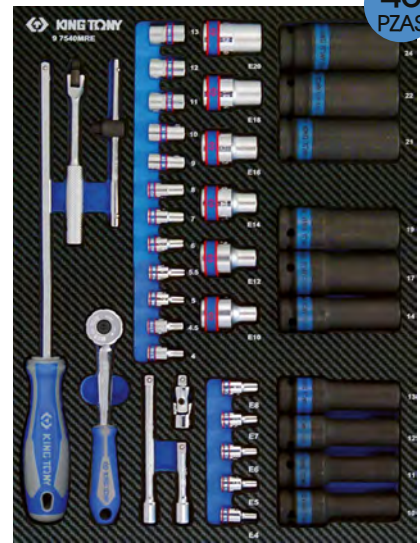

40 PZAS

**97540MRE** #9 167€<sup>B</sup>

Contiene (1/4") (1/2") 3.36

	2335M	4, 4.5, 5, 5.5, 6, 7, 8, 9, 10, 11, 12, 13
	2375M	E4, E5, E6, E7, E8
	4375M	E10, E12, E14, E16, E18, E20
	4435M	10, 11, 12, 13, 14, 17, 19, 21, 22, 24

275555G 2792 2177NU 257145 245205F 222102, 222104



62 PZAS

**92562MRE** (1/4") #9 149€<sup>B</sup>

Contiene 1.6

	2335M	3, 2, 4, 5, 5.5, 6, 7, 8, 9, 10, 11, 12, 13, 14
	2235M	4, 4.5, 5, 5.5, 6, 7, 8, 9, 10, 11, 12, 13, 14
	1025P	PH1, PH2, PH3
	1025S	3, 4, 5, 6
	1025H	H3, H4, H5, H6
	1025Z	PZ1, PZ2, PZ3
	1025T	T10, T15, T20, T25, T27, T30, T40
	1025U	T10H, T15H, T20H, T25H, T27H, T30H, T40H

277355GS 278106P 2133NU 2178DF 75260 770225 2792 2142 2813

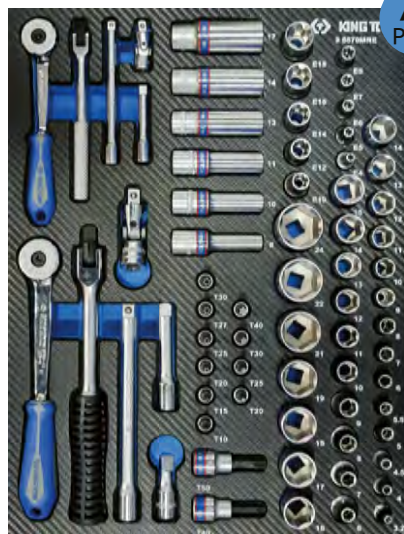

70 PZAS

**95570MRE** #9 208€<sup>B</sup>

Contiene (1/4") (3/8") 3.2

	2335M	3, 2, 4, 4.5, 5, 5.5, 6, 7, 8, 9, 10, 11, 12, 13, 14
	3335M	6, 7, 8, 9, 10, 11, 12, 13, 14, 15, 16, 17, 18, 19, 21, 22, 24
	3235M	8, 10, 11, 12, 14, 17
	2375M	E4, E5, E6, E7, E8
	3375M	E10, E12, E14, E16, E18
	2033	T20, T25, T30, T40
	2037	T10H, T15H, T20H, T25H, T27H, T30H
	3027	T40H, T50H

275555G 375508G 245205F 345208G 2792 222102, 222104 322116, 322103, 322106 3792



40 PZAS

**99040SRV01** #9 153€<sup>B</sup>

Contiene (1/4") (3/8") (1/2") 3.02

	2330S	5/32", 3/16", 7/32", 1/4", 9/32", 5/16", 11/32", 3/8", 7/16", 1/2"
	3330S	3/8", 7/16", 1/2", 9/16", 5/8"
	4330S	3/8", 7/16", 1/2", 9/16", 5/8", 11/16", 3/4", 13/16", 7/8", 15/16", 1", 1-1/8", 1-1/4"

5060 1/4", 5/16", 3/8", 7/16", 1/2", 9/16", 5/8", 11/16", 3/4", 7/8", 15/16", 1"

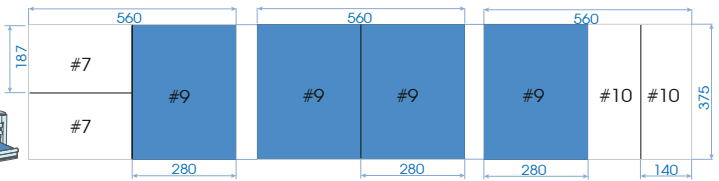
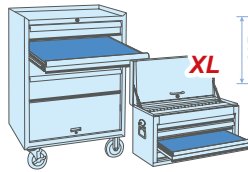
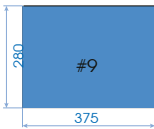

44  
PZAS

**93544MRV (3/8") #9** 195€<sup>B</sup>

Contiene 3.19

- 3335M 10, 11, 12, 13, 14, 15, 16, 17, 18, 19, 20, 21, 22
- 3375M E7, E8, E10, E11, E12
- 3230M 8, 10, 11, 12, 13, 14, 16, 17, 19
- 3750M 10, 11, 12, 13, 14, 15, 16, 17, 18, 19
- 377908G 3812, 3814
- 322314 322103, 322106, 322110

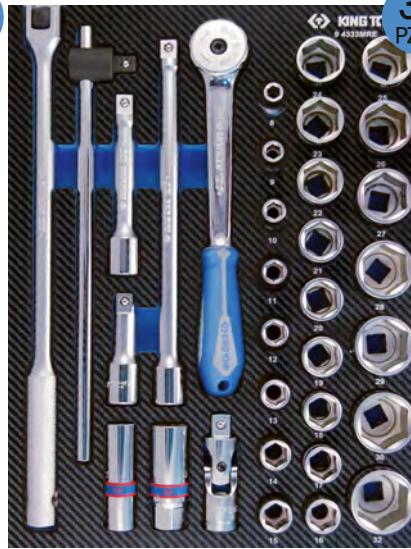

33  
PZAS

**94333MRE (1/2") #9** 196€<sup>B</sup>

Contiene 5.3

- 4335M 8, 9, 10, 11, 12, 13, 14, 15, 16, 17, 18, 19, 20, 21, 22, 23, 24, 25, 26, 27, 28, 29, 30, 32
- 463516M, 463521R
- 475510G 457212
- 445218F 4791
- 425103, 425105, 425110



37  
PZAS

**94537MRV (1/2") #9** 199€<sup>B</sup>

Contiene 4.39

- 4335M 8, 10, 11, 12, 13, 14, 15, 16, 17, 18, 19, 20, 21, 22, 23, 24, 26, 27, 28, 30, 32
- 4375M E10, E12, E14, E16, E18, E20, E22, E24
- 463516R, 463521R
- 463014RC
- 477910GR 4791
- 429302 425105R, 425110R

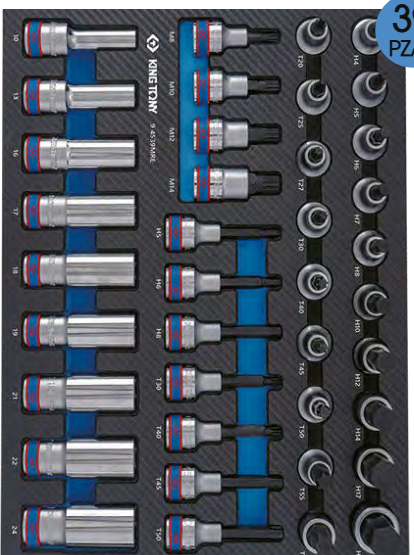

39  
PZAS

**94539MRE (1/2") #9** 226€<sup>B</sup>

Contiene 5.26

- 4235M 10, 13, 16, 17, 18, 19, 21, 22, 24
- 4023 T20, T25, T27, T30, T40, T45, T50, T55, T60
- 4025 H4, H5, H6, H7, H8, H10, H12, H14, H17, H19
- 4026 M8, M10, M12, M14
- 4033 T30, T40, T45, T50
- 4035 H5, H6, H8



21  
PZAS

**94221MRV (1/2") #9** 186€<sup>B</sup>

Contiene 3.92

- 4230M 8, 9, 10, 11, 12, 13, 14, 15, 16, 17, 18, 19, 21, 22, 24, 27, 30, 32, 33, 34, 36



19  
PZAS

**94419MPE (1/2") #9** 199€<sup>B</sup>

Contiene 5.6

- 4435M 10, 11, 12, 13, 14, 15, 16, 17, 18, 19, 21, 22, 24, 27, 30, 32, 33, 34, 36

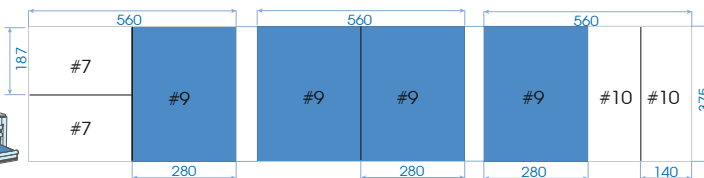
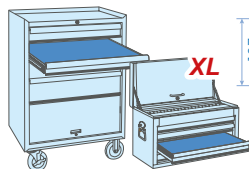
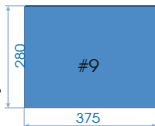

60 PZAS

97560MRV01 #9 229€<sup>B</sup>

Contiene 6.24

	2335M	4, 5, 5.5, 6, 7, 8, 9, 10, 11, 12, 13, 14	
	4335M	10, 11, 13, 14, 15, 16, 17, 18, 19, 20, 21, 22, 24, 27, 30, 32	
	1025S	3,0, 4,5, 5, 6,5, 83,0, 4,5, 5, 6,5, 8	
	1025P	PH0, PH1, PH2, PH3	
	1025U	T10H, T15H, T20H, T25H, T27H, T30H, T40H	
	1025Z	PZ1, PZ2, PZ3	
	276A04G	477110GR	445215FR
	457212	213312DF	2792
	4791R	2813	2745
	222302, 222304	425105R, 425110R	



20 PZAS

91220MRV #9 156€<sup>B</sup>

Contiene 3.49

	1060	6, 7, 8, 9, 10, 11, 12, 13, 14, 15, 16, 17, 18, 19, 21, 22, 24, 27, 30, 32
--	------	--



16 PZAS

912D16MRE1 #9 139€<sup>B</sup>

Contiene 3.3

	1062	6, 8, 10, 11, 13, 14, 16, 17, 18, 19, 21, 22, 24, 27, 30, 32
--	------	--



19 PZAS

912D19MRE1 #9 125€<sup>B</sup>

Contiene 2.5

	1062	6, 7, 8, 9, 10, 11, 12, 13, 14, 15, 16, 17, 18, 19, 20, 21, 22, 23, 24
--	------	--



20 PZAS

912D20MRE #9 159€<sup>B</sup>

Contiene 2.6

	1062	6, 7, 8, 9, 10, 11, 12, 13, 14, 15, 16, 17, 18, 19, 21, 22, 24, 27, 30, 32
--	------	--



5 PZAS

912D05MRE #9 97€<sup>B</sup>

Contiene 2.6

	1062	27, 28, 29, 30, 32
--	------	--------------------



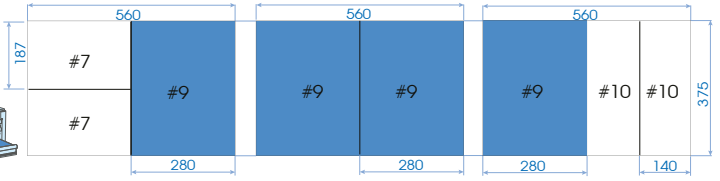
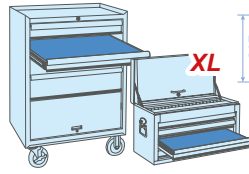
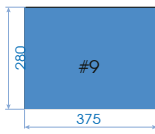

8  
PZAS

9122A08MRE #9 189€<sup>B</sup>

Contiene 1.6

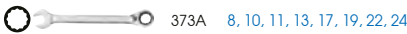

14  
PZAS

9122A14MRE #9 283€<sup>B</sup>

Contiene 2.36

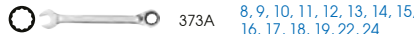

12  
PZAS

91112MRE #9 106€<sup>B</sup>

Contiene 2.6



**373AM**

**Retén antideslizante**

- ✓ Gracias al retén antideslizante en el ojo, estas llaves no resbalan en las tuercas.
- ✓ Se trabaja más rápido y aumenta la productividad y la seguridad.

Reversible

13°

5°



7  
PZAS

991107MRE01 #9 259€<sup>B</sup>

Contiene 1.1

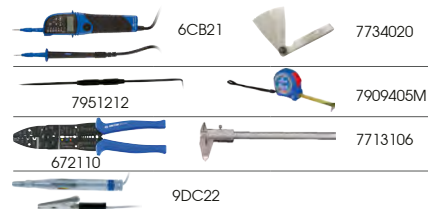

21  
PZAS

990221MRE01 #9 149€<sup>B</sup>

Contiene 1.94

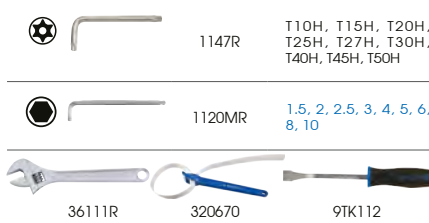

7  
PZAS

990407GQE #9 159€<sup>B</sup>

Contiene 1.2



KING TONY



90  
PZAS

**991190CRE #9** 179€<sup>B</sup>

Contiene		🔧 2.22
	1025S 3.0, 4.0, 5.0, 6.0	
	1025P PH1, PH2 x 2, PH3	
	1025Z PZ1, PZ2 x 2, PZ3	
	1025T T10, T15, T20, T25, T27, T30, T40	
	1025H H3, H4, H5, H6	
	1025U T10H, T15H, T20H, T25H, T27H, T30H, T40H	
	1025R RB2	
	770225  75363	
	10D0 10,12,13,14,17,18,19	
	1130MR H2.5, H3, H4, H5, H6, H8, H10	
	1130SR 3/32", 1/8", 5/32", 3/16", 1/4", 5/16", 3/8"	
	1147R T10H, T15H, T20H, T25H, T27H, T30H, T40H	
	361106R, 361108R	
	7732826	
	276A04G	



61  
PZAS

**991161CQE #9** 128€<sup>B</sup>

Contiene		🔧 1.4
	1636H H4, H5, H6, H7, H8, H10, H12	
	1636T T20, T25, T27, T30, T40, T45, T50, T55, T60	
	1636M M5, M6, M8, M10, M12	
	1680H H4, H5, H6, H7, H8, H10, H12	
	1680T T20, T25, T27, T30, T40, T45, T50, T55, T60	
	1680M M5, M6, M8, M10, M12	
	1127R T10H, T15H, T20H, T25H, T27H, T30H, T40H, T45H, T50H	
	1120MR H1.5, H2, H2.5, H3, H4, H5, H6, H8, H10	
	414710M	



22  
PZAS

**990222MRE #9** 144€<sup>B</sup>

Contiene		🔧 1.94
	1120MR H1.5, H2, H2.5, H3, H4, H5, H6, H7, H8	
	1147R T10, T15, T20, T25, T27, T30, T40, T45, T50	
	651710C	631106
	611108 (990222MRE) / 611107 (990222MRE01)	621106

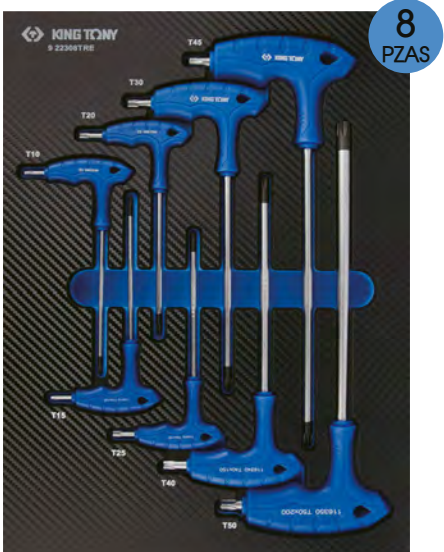

8  
PZAS

**922308TRE #9** 73€<sup>B</sup>

Contiene		🔧 1.1
	1163TR T10, T15, T20, T25, T30, T40, T45, T50	



9  
PZAS

**91019GRE #9** 89€<sup>B</sup>

Contiene		🔧 1.7
	764G Ø 2, Ø 3, Ø 4, Ø 5, Ø 6, Ø 8	
	762G 18, 22	
	9TK112	

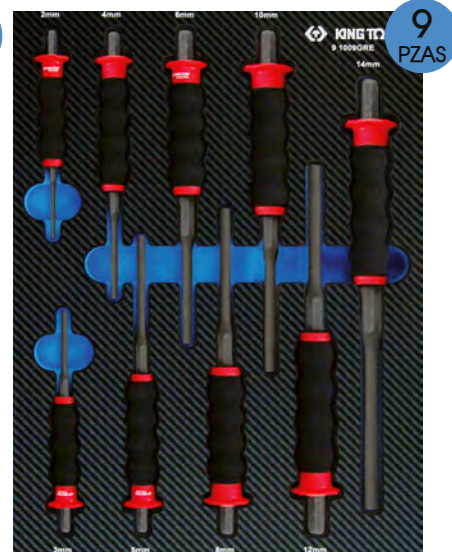

9  
PZAS

**91009GPE #9** 99€<sup>B</sup>

Contiene		🔧 2.0
	764G Ø 2, Ø 3, Ø 4, Ø 5, Ø 6, Ø 8, Ø 10, Ø 12, Ø 14	

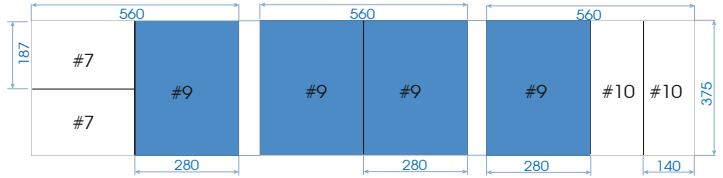
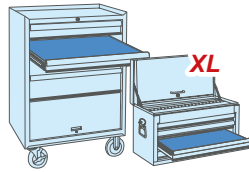
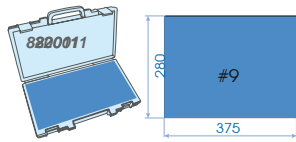

31  
PZAS

990131MRE #9 163€<sup>B</sup>



Contiene

3.1

	4033	T20, T25, T27, T30, T40, T45, T50, T55, T60
	4035	H4, H5, H6, H7, H8, H10, H12, H14, H17
	1120MR	H1.5, H2, H2.5, H3, H4, H5, H6, H8, H10
	1930	10 x 11, 12 x 14, 14 x 17
	3204	Ø 60 ~ 140



5  
PZAS

91905MRE #9 103€<sup>B</sup>

Contiene

0.82



10 x 12, 11 x 13, 14 x 17, 16 x 18, 19 x 22

## COMPOSICIONES EN TERMOFORMADO



25  
PZAS

94435MP #9 216€<sup>B</sup>

Contiene

7.3



4435M 8, 9, 10, 11, 12, 13, 14, 15, 16, 17, 18, 19, 20, 21, 22, 23, 24, 25, 26, 27, 28, 29, 30, 32, 36



17  
PZAS

94147PRV 1/2" #10 145€<sup>B</sup>

Contiene

1.81

	40D0	H6, H8, H10
	4066	M8, M9, M10, M12, M14
	4023	T20, T25, T27, T30, T40, T45, T50, T55, T60



121  
PZAS

9212007MRV #10 53€<sup>B</sup>

Contiene

0.91



2120101 4.8 x 10, 4.8 x 8, 4 x 10, 4 x 8



4  
PZAS

942154GPV #10 77€<sup>B</sup>

Contiene

0.8

	66HS07		66HB07
	66SB07		66SS07



6 PZAS



**91306MRE #7** 62€ B

Contiene 1.0  
 1930 8x10, 10x12, 11x13, 12x14, 17x19, 19x22

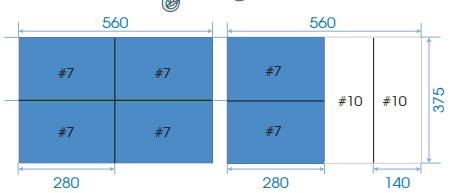
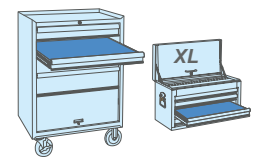
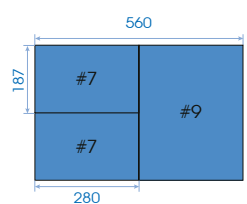
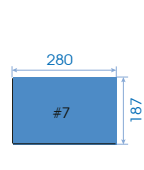
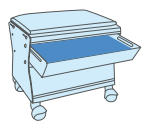

12 PZAS



**910112MRE #7** 163€ B

Contiene 1.13  
 3731M 8x10, 10x12, 11x13, 12x14, 17x19, 19x22



COMPOSICIONES EN TERMOFORMADO



27 PZAS

**94427MP 1/2" #7** 156€ B

Contiene 4.09  
 4535M 8, 9, 10, 11, 12, 13, 14, 15, 16, 17, 18, 19, 20, 21, 22, 23, 24, 25, 26, 27, 28, 29, 30, 32, 33, 34, 36

COMPOSICIONES EN TERMOFORMADO



15 PZAS

**9102A15MR #4** 259€ B

Contiene 1.9  
 373A 8, 9, 10, 11, 12, 13, 14, 15, 16, 17, 19, 22

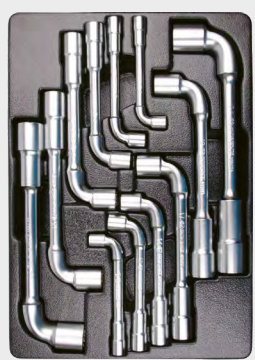
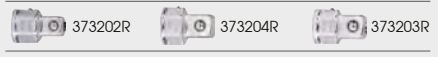

12 PZAS

**91912MR #4** 116€ B

Contiene 3.69  
 1081 8, 10, 11, 12, 13, 14, 16, 17, 18, 19, 22, 24

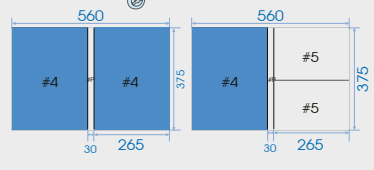
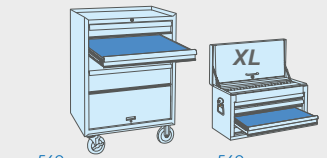
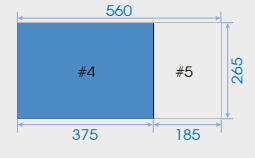
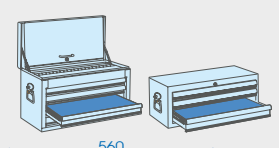
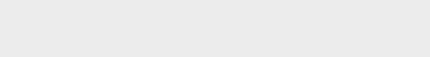

12 PZAS

**9102A12MR #5** 199€ B

Contiene 1.22  
 373AM 10, 11, 12, 13, 14, 15, 16, 17, 19

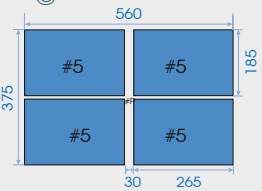
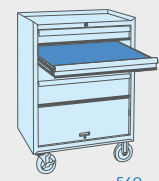
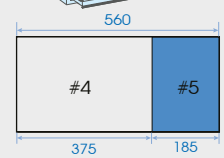
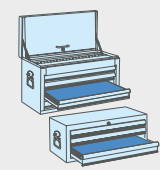
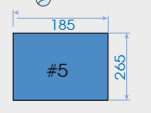
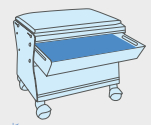
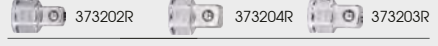

# APRIETE CONTROLADO

**62**  
SERIES

PRECISIÓN  
+/- 3%



**34\_62\_DG**

## LLAVES DINAMOMÉTRICAS PARA USO INTENSIVO

DIN ISO 6789 y ASME B107.300-2010.

Diseñadas para un ajuste fácil del par de apriete.

Precisión de par garantizado al ±3% (sentido horario /CW).

Cambio del sentido de rotación con palanca.

Accionamiento en sentido horario (CW) y antihorario (CCW).



Ajuste fácil del par de apriete con retorno automático



Empuñadura cómoda de goma



PUSH BUTTON



3/4" y 1" sin Push button

	Cuadrado conductor	Capacidad de par Nm	Graduación	Número de dientes	Largo total mm	kg	
342621DG	1/4"	4-20 Nm	0.1 Nm	24	324	0.64	128€ B
342622DG	1/4"	2-10 Nm	0.1 Nm	24	281	0.56	109€ B
342623DG	1/4"	5-30 Nm	0.5 Nm	24	325	0.64	119€ B
343621DG	3/8"	4-20 Nm	0.1 Nm	32	324	0.64	115€ B
343622DG	3/8"	20-100 Nm	0.5 Nm	32	435	1.30	134€ B
343623DG	3/8"	10-60 Nm	0.5 Nm	32	325	1.30	127€ B
344621DG	1/2"	40-200 Nm	1 Nm	32	521	1.59	139€ B
344622DG	1/2"	60-340 Nm	2 Nm	32	613	1.81	139€ B
344623DG	1/2"	20-100 Nm	1 Nm	32	435	1.30	138€ B
344624DG	1/2"	80-400 Nm	2 Nm	32	613	1.97	136€ B
346621DG	3/4"	100-600 Nm	5 Nm	24	1048	5.50	409€ B
346622DG	3/4"	150-800 Nm	5 Nm	24	1234	5.60	509€ B
346623DG	3/4"	200-1000 Nm	5 Nm	24	1238	6.15	539€ B
348621DG	1"	200-1000 Nm	5 Nm	24	1238	6.15	549€ B

**62**  
SERIES

PRECISIÓN  
+/- 3%



**348622DG**

1"

899€ B

⚠ Esta llave dinamométrica debe ser utilizada con su extensión. No usarla provocará una imprecisión en el par de apriete o daños.

## LLAVE DINAMOMÉTRICA PARA USO INTENSIVO

DIN ISO 6789 y ASME B107.300-2010. Diseñada para un ajuste fácil del par de apriete. Precisión de par garantizado al ±3% (sentido horario /CW). Cambio del sentido de rotación con palanca. Accionamiento en sentido horario (CW) y antihorario (CCW).

	Cuadrado conductor	Capacidad de par Nm	Graduación	Largo total mm	kg
348622DG	1"	300-1500 Nm	10 Nm	1850	12.2



**6A**  
SERIES

PRECISIÓN  
+/- 3%

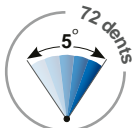

Empuñadura cómoda de goma



Ajuste fácil del par de apriete con retorno automático

## LLAVES DINAMOMÉTRICAS PARA USO INTENSIVO

DIN ISO 6789 y ASME B107.300-2010.

Versión con carraca redonda fija para los espacios reducidos

Ángulo de repris de 5°

Push-button con acabado premium rojo. DIN ISO 6789 y

ASME B107.300-2010. Precisión de par garantizado al ±3% (sentido

horario /CW). Inversión del sentido de rotación por rueda.

Accionamiento en sentido horario (CW) y antihorario (CCW).



	Cuadrado conductor	Capacidad de par Nm	Graduación	Largo total mm	kg
3436A2DG	3/8"	20-100 Nm	0.5 Nm	430	1.30
3446A1DG	1/2"	40-200 Nm	1 Nm	490	1.46
3446A2DG	1/2"	60-340 Nm	2 Nm	590	1.75



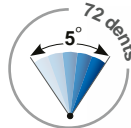

### 3426D1DA

#### MINI LLAVE DINAMOMÉTRICA EN ALUMINIO PARA BICICLETAS

DIN ISO 6789 y ASME B107.300-2010. Versión con carraca redonda fija para los espacios reducidos. Ángulo de reprís de 5°. Push-button con acabado premium rojo. DIN ISO 6789 y ASME B107.300-2010. Precisión de par garantizado al ±4% (sentido horario /CW). Inversión del sentido de rotación por rueda. Accionamiento en sentido horario (CW) y antihorario (CCW).



	Cuadrado conductor	Capacidad de par Nm	Graduación	Largo total mm	kg	
3426D1DA	1/4"	3 - 16 Nm	0.1 Nm	172	214	129€ <sup>B</sup>



### 3426D1D23MR

1/4"

145€<sup>B</sup>

23  
PZAS

#### COFRE CON MINI LLAVE DINAMOMÉTRICA Y PUNTAS

199 x 161 x 56 mm

Contiene

kg 0.72

	3426D1DA	3~16 Nm
	1025S	3, 4, 5, 5.5, 6
	1025P	PH0, PH1, PH2, PH3
	1025H	H3, H4, H5, H6, H8, H10
	1025T	T10, T15, T20, T25, T30
	2142	
	222104	



### SWITCH SERIES

PRECISIÓN  
+/- 3%



Ajuste fácil del par de apriete con retorno automático



Empuñadura cómoda de goma

PUSH

Para un cambio rápido y fácil de las puntas

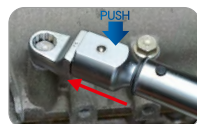

CANTIDAD LIMITADA



### 345\_DG

#### LLAVES DINAMOMÉTRICAS DE USO INTENSIVO PARA CABEZAS INTERCAMBIABLES

DIN ISO 6789 & ASME B107.300-2010. Fijación rectangular para cabezas intercambiables estándares. Precisión del par garantizado al ±3% (apriete). Modos de apriete (CW) y aflojamiento (CCW).

	Fijación mm	Capacidad del par Nm	Graduación	Largo total mm	kg	
345121DG	9 x 12	2-10 Nm	0.1 Nm	261	0.51	100€ <sup>B</sup>
345122DG	9 x 12	4-20 Nm	0.1 Nm	306	0.59	100€ <sup>B</sup>
345123DG	9 x 12	20-100 Nm	0.5 Nm	430	1.27	122€ <sup>B</sup>
345223DG	14 x 18	60-340 Nm	2 Nm	580	1.59	139€ <sup>B</sup>
345224DG	14 x 18	100-600 Nm	5 Nm	1015	6.20	379€ <sup>B</sup>
345226DG	14 x 18	150-800 Nm	5 Nm	1195	6.62	389€ <sup>B</sup>
345227DG	14 x 18	70-350 Nm	2 Nm	580	1.80	139€ <sup>B</sup>
345228DG	14 x 18	200-1000 Nm	5 Nm	1200	6.62	419€ <sup>B</sup>
345229DG	14 x 18	80-400 Nm	2 Nm	580	1.78	139€ <sup>B</sup>



PRECISIÓN +/- 2%

AA x 2 incluida

**346071A** 3/4" 165€<sup>B</sup>

**ADAPTADOR DINAMOMÉTRICO ELECTRÓNICO**

Lectura directa del par en la pantalla LCD. Timbre y avisador visual cuando se obtiene el par. Autonomía: 110 horas.

Código	Cuadrado conductor	Capacidad de Par				Memoria
		Nm	Grad.	ft.lb	kgf.m	
346071A	3/4"	200-1000 Nm	0.1 Nm	147.6-738 ft.lb	20.4-102 kgf.m	50



Cuidado: comprobar previamente el par de apriete

10 PZAS



**1E10MR** 3/8" 94€<sup>B</sup>

**JUEGO DE PUNTAS CROWFOOT SOBRE RÁIL**

Punta CROWFOOT. Bi-hexagonal para tuberías. Para accesos reducidos.

Contiene 1031R 10, 11, 12, 13, 14, 15, 16, 17, 18, 19 mm

También disponible en longitudes de 1/2" y 3/4"  
**22** ➔ **50 mm**



Se usa con vasos de impacto. No usar herramientas energizadas (llaves de impacto...). No usar alargador.

PRECISIÓN +/- 5%

540 Nm max. 3/4"  
2700 Nm max. 1"



7.4

**3468805A** 5:1 490€<sup>B</sup>

**MULTIPLICADOR DE PAR 5:1**

Precisión ± 5%. 2 estilos de barras de reacción (recta y acodada).

PRECISIÓN +/- 5%

1/2" 173 Nm max.  
4500 Nm max. 1"



8.9

**3448826** 26:1 1780€<sup>B</sup>

**MULTIPLICADOR DE PAR 26:1**

Precisión ± 5%. Función anti-retorno de fuerza. 2 estilos de barras de reacción (recta y acodada).



PRECISIÓN +/- 2%

**344171A** 1/2" 169€<sup>B</sup>

**ADAPTADOR DINAMOMÉTRICO DE ÁNGULO**

Contiene: un adaptador dinamoétrico y angular, un adaptador de control, un adaptador de 1/2" x 1/4" y un adaptador de 1/2" x 3/8".

Código	Cuadrado conductor	Capacidad de Par				Memoria
		Nm	Grad.	ft.lb	kgf.m	
344171A	1/2"	40-200 Nm	0.1 Nm	29.5-147.5 ft.lb	4.08-20.38 kgf.m	10



Mayor sujeción gracias a su flexible magnético e imán.



375

**34440A** 1/2" 37€<sup>B</sup>

**LLAVE DE APRIETE ANGULAR**

El cuadrado permite al operador apretar con precisión hasta el ángulo deseado. Placa de composite transparente con aguja integrada, protegiendo el cuadrado de la suciedad y la grasa. Escala angular de 360°, con graduación de 2° e intervalos de 10° y 30°.



8  
PZAS

328 x 123 x 60 mm

**345102D08MR** 206€<sup>B</sup>

**CAJA DE LLAVES DINAMOMÉTRICA  
CON CABEZAS INTERCAMBIABLES (4~20 NM)**

Caja de plástico. Fijación 9x12mm.

Contiene		1.3
	345011M 10, 13, 17	
	345021M 10, 13, 17	
	1/4" 34503102R	
	345122DG	



11  
PZAS

618 x 153 x 65 mm

**345202D11MR** 327€<sup>B</sup> **345203D11MR** 347€<sup>B</sup>

**CAJA DE LLAVES DINAMOMÉTRICA  
CON CABEZAS INTERCAMBIABLES  
(40~200 NM)**

3.8

Caja de plástico. Fijación 14x18mm.

Contiene	
	345202D11MR 345222DG
	345203D11MR 345223DG
	345012M 13, 14, 15, 17, 19, 22, 24, 27, 30 mm
	1/2" 34503204R

**CAJA DE LLAVES DINAMOMÉTRICA  
CON CABEZAS INTERCAMBIABLES  
(60~340 NM)**

4.0



PRECISIÓN  
+/- 5%

Para puntas  
hexagonales 1/4"



Ajuste del par  
mediante el  
anillo azul



**New**

**34011\_DG**

1/4"

**DESTORNILLADOR DINAMOMÉTRICO**

DIN ISO 6789 y ASME B107.300-2010. Graduación laser de fácil lectura. Empuñadura ergonómica de goma. Estructura en aleación de aluminio.

		Capacidad del par	Graduación	Largo mm	1.3	
		cNm / Nm				
<b>34011DG</b>	1/4"	30~120 cNm	1 cNm	180	207	129€ <sup>B</sup>
<b>34012DG</b>	1/4"	1.5 - 6.5 Nm	0.1 Nm	196	475	134€ <sup>B</sup>



PRECISIÓN  
+/- 5%

Con un cuadrado  
conductor 1/4"



**342113DG**

1/4"

140€<sup>B</sup>

**DESTORNILLADOR DINAMOMÉTRICO PORTA VASOS 1/4"**

DIN ISO 6789 & ASME B107.300-2010. Tolerancia ±5%. Con un cuadrado conductor 1/4. Lectura directa del par. Certificado de calibrado suministrado. Ajuste del par con el anillo azul. Estructura en aleación de aluminio. Empuñadura ergonómica y cómoda. Graduación de pares grabada con láser.

		Capacidad del par	Graduación	Largo mm	1.3
		Nm			
<b>342113DG</b>	1/4"	4 ~ 9 Nm	0.1 Nm	196	475

# EXTRACTORES



## 7962B

### EXTRACTOR UNIVERSAL 2 GARRAS

Garras correderas e intercambiables. Apriete rápido y preciso.

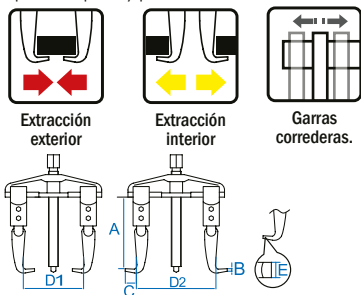

	Potencia Toneladas	A mm	B mm	C mm	D1 mm	D2 mm	E mm	mm	kg	
7962B35	3T	100	3.8	14.5	90	60-125	21	17	1.05	75€ B
7962B05	5T	100	3.8	14.5	130	60-160	21	17	1.15	79€ B
7962B06	5T	150	4.6	23	150	85-200	30	22	2.98	126€ B
7962B08	7.5T	150	4.6	23	190	105-230	30	22	3.41	145€ B
7962B10	7.5T	210	7.0	30	240	130-300	35	27	7.11	245€ B



## 7963

### EXTRACTOR 3 GARRAS ARTICULADAS

Garras articuladas y reversibles.

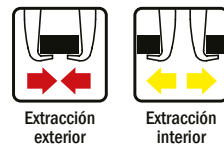

	Potencia Toneladas	mm	mm	mm	kg	
796303	0.5T	60	85	14	0.55	40€ B
796304	1T	95	110	17	1.06	52€ B
796306	4T	160	160	19	2.25	86€ B
796308	7T	235	210	23	4.50	155€ B
796312	10T	330	310	32	11.0	428€ B



## 796313ALT

### EXTRACTOR 3 GARRAS ARTICULADAS

Versión extra larga.



**CANTIDAD LIMITADA**

	Potencia Toneladas	mm	mm	mm	kg	
79631301ALT	1T	105	110	12	1.0	165€ B
79631304ALT	4T	185	175	16	2.5	209€ B
79631307ALT	7T	225	240	19	6.5	317€ B
79631310ALT	10T	385	360	22	14.5	649€ B
79631317ALT	17T	480	480	27	31.5	1079€ B
79631330ALT	30T	585	580	37	55.5	1449€ B



## 796373ALT

### EXTRACTOR CON 3 GARRAS LARGAS ARTICULADAS Y AUTO CENTRADAS

Versión extra larga.



Garras finas con muescas para acceso difícil o con tornillo.

	Potencia Toneladas	A mm	B mm	mm	kg	
79637304ALT	4T	210	220	16	2.5	229€ B



## 796227

### EXTRACTOR LIGERO CON 2 GARRAS AUTO-CENTRADAS

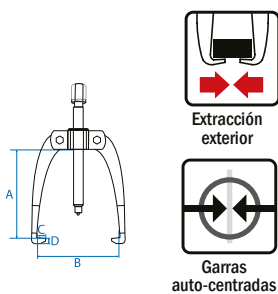

	Potencia Toneladas	A mm	B mm	C mm	D mm	kg	
79622741	1T	80	80	10.7	7.9	0.47	57€ B
79622743	3T	122	116	11	8.1	0.87	70€ B
79622745	5T	161	160	14.2	11.1	1.79	104€ B
79622748	8T	202	200	19	14.5	3.26	124€ B



## 796327T

### EXTRACTOR LIGERO CON 3 GARRAS AUTO-CENTRADAS

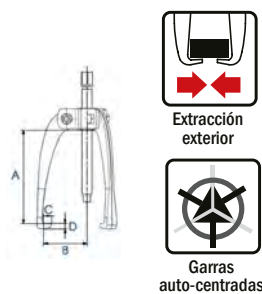

	Potencia Toneladas	A mm	B mm	C mm	D mm	kg	
79632741T	1T	80	80	10.7	7.9	0.59	71€ B
79632743T	3T	122	116	11	8.1	1.09	85€ B
79632745T	5T	161	160	14.2	11.1	2.28	129€ B
79632748T	8T	202	200	19	14.5	4.18	148€ B

Oferta válida del 01/01/2025 al 31/12/2025. Precio recomendado de venta al público en euros sin IVA. Fotos no contractuales.

**New**



Convertible a 2 o 3 garras.



Garras reversibles



## 7963C

### EXTRACTOR CON 2 Ó 3 GARRAS REVERSIBLES

Para extracción interna y externa. La innovadora estructura de garras permite sustituir las mordazas de forma rápida y cómoda, maximizando la eficacia. Las garras reversibles ofrecen una versatilidad excepcional, adecuadas para engranajes internos y externos, ejes, cojinetes, etc.



Extracción exterior

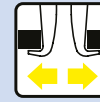

Extracción interior



Convertible en 2 o 3 garras



Ajuste rápido del alcance de uso gracias al sistema de muescas.

	Potencia Toneladas	A mm	B mm	mm	kg	
7963C03	2 T	50-76	45	13	0.45	72€ <sup>B</sup>
7963C05	5 T	101-127	75	17	1.50	119€ <sup>B</sup>
7963C08	8 T	127-200	172	17	2.89	149€ <sup>B</sup>



## 796226

### EXTRACTORES CON GARRAS CRUZADAS PARA PIÑÓN

Versión garra ancha. Garras articuladas. Conjunto monobloc.

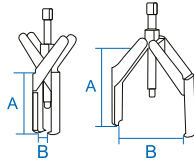

Extracción exterior

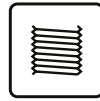

Roscado fino

	Potencia Toneladas	A mm	B máx mm	B mín mm	mm	Característica del tornillo mm	kg	
79622641	1 T	90	95	55	12	M10x1	0.3	92€ <sup>B</sup>
79622642	4 T	125	125	70	16	M14x1,50	0.8	109€ <sup>B</sup>
79622643	7 T	160	125	80	19	M14x1,50	1.0	145€ <sup>B</sup>



## 796502

71€<sup>B</sup>

### EXTRACTOR DE MICRO-RODAMIENTOS

Ideal para alternadores, generadores, electrodomésticos, herramientas eléctricas y bombas. Ajuste los brazos girando el tornillo.

	Potencia Toneladas	A mm	B mm	kg
796502	2 T	19 - 45	73	905

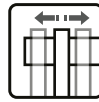

Garras correderas

## 9BE5077C

183€<sup>B</sup>

### COFRE DE EXTRACTOR CON 2 GARRAS PARA POLEA DE ALTERNADOR

Suministrado con varias puntas de tornillo central para una extracción perfecta. Con adaptador largo. Garras correderas. Pensado para los rodamientos de alternador.



mm

mm

mm

kg

## 9BE5077C

63-100

11-50

14

1.3



## 796218C

### COFRE DE EXTRACTORES MULTI-USO 2 GARRAS

Para una extracción interior, exterior, por roscado, para espacios reducidos. 4 garras adicionales. Entregado con un adaptador que protege la punta.



Extracción exterior

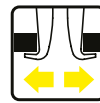

Extracción interior



Roscado fino

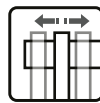

Garras correderas.

mm

mm

mm

mm

Potencia Toneladas

kg

79621805C

17

173

140

9/16"x12h

5 T

2.7

213€<sup>B</sup>

79621810C

22

250

182

3/4"x12h

10 T

6.0

299€<sup>B</sup>

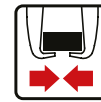
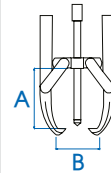

Extracción exterior

## 7969300K

203€<sup>B</sup>

### COFRE DE EXTRACCIÓN "MICRO"

Contiene

kg 1.3



79629300 (B: 70, A: 55),

79629301 (B: 100, A: 85)



79639300T (B: 70, A: 55),

79639301T (B: 100, A: 85)

2 en 1



18 PZAS

**9BA9082** 365€<sup>B</sup>

**COFRE DE EXTRACCIÓN ESPECIAL ATORNILLAMIENTO**

Para una extracción interior, exterior, por roscado. Profundidad de 120 mm. Separador de 110 mm.



Extracción exterior Extracción interior Garras correderas.

Contiene 2.8

	9BA1100	9BA1102
	9BA1200	9BA1202A



6 PZAS

**796401MR** 185€<sup>B</sup>

**COFRE DE EXTRACTORES DE RODAMIENTOS CON MAZA DE INERCIA**

Para trabajos que involucran engranajes de tracción y agarre, rodamientos, anillos exteriores, retenedores de grasa, sellos de aceite, etc. Maza deslizante de 1,2 kg (2,6 lb). Empuñadura de extracción en T de 400 mm de largo. Extractor con maza de inercia 3 en 1 para manipular la tracción interior, como copas de rodamiento y anillos exteriores, así como tareas de tracción exteriores.

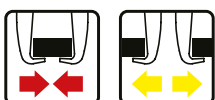

Extracción exterior Extracción interior

Contiene 4.5

- 1 empuñadura en T de 400 mm
- 1 maza de 1,2 kg (2,6 lb)
- 1 tuerca regulable
- 1 extractor de rodamientos interior Ø15-30 mm (A)
- 1 extractor de rodamientos interior Ø30-80 mm (B)
- 1 extractor de rodamientos exterior Ø15-80 mm (C)

3 en 1

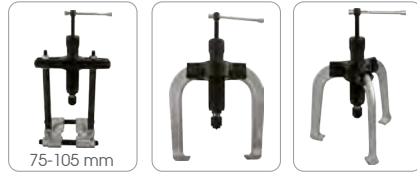

Guillotina y despegador 75-105 mm Extractor 2 garras Extractor 3 garras

25 PZAS

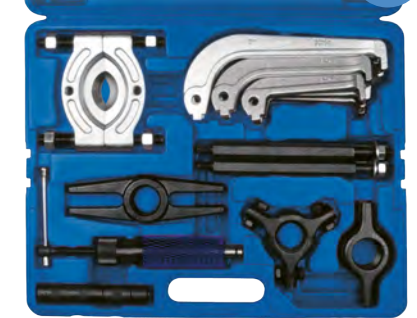

**9BA01** 1/2" 379€<sup>B</sup>

**COFRE CON EXTRACTOR HIDRÁULICO**

Multifunción con despegador de acero forjado. Extractor de engranaje con garras. 10 toneladas de potencia de tracción hidráulica. El diseño del despegador permite usar el extractor en espacios estrechos.

Contiene 17

- 1 guillotina
- 1 despegador 75-105 mm
- 2 tirantes (255 mm)
- 2 extensiones (255 mm)
- 1 tornillo hidráulico de 10T
- 1 accesorio para el eje
- 1 adaptador central
- 1 base para 3 garras
- 1 base para 2 garras
- 3 garras de 102 mm (4")
- 3 garras de 152 mm (6")
- 3 garras de 203 mm (8")
- 1 extensión 25 x 51 mm (1"x2")
- 1 extensión 25 x 102 mm (1"x4")

Producto compatible



79634704



7.2

**9BA4396** 293€<sup>B</sup>

**MASA DE INERCIA PARA 79634704**

Extensión de 375mm suministrada. Masa de 5000 gramos, diámetro 58mm. Largo total de 880mm con 750mm de golpe.



Garras auto-centradas Extracción exterior Extracción interior

5/8" 18h

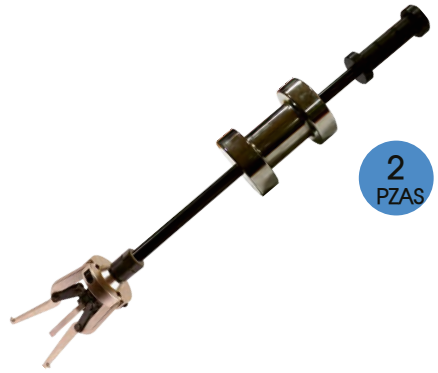

2 PZAS

**P9BA4396** 729€<sup>B</sup>

**CONJUNTO MASA DE INERCIA CON EXTRACTOR 3 GARRAS**

Extracción por inercia. Para una extracción interior y exterior. 79634704 - Ancho del alcance interior : 95-150 mm. 79634704 - Ancho del alcance exterior : 45-97 mm.



Extracción exterior Extracción interior Garras auto-centradas Convertible en 2 o 3 garras

Contiene 9.3

	79634704	
	9BA4396	5/8" 18h



17 PZAS



**9BQ01** 161€<sup>B</sup>

**COFRE DE EXTRACTORES DE BUJES CON MASA DE INERCIA**

3-en-1: tracción interior, tracción exterior, desabollado. Para la extracción de buje, de eje, de rodamientos y para el desabollado, etc.

Contiene 7.5

- 1 empuñadura en T de 500 mm
- 1 masa de 2,2 kg (5 lb)
- 1 extractor de eje
- 1 extractor de bujes
- 1 gancho
- 1 adaptador para mordaza de presión
- 1 herramienta para desabollado
- 1 centrador con tornillos
- 1 soporte para 2 garras
- 1 soporte para 3 garras
- 1 tuerca regulable
- 3 extensiones de 3,5"
- 3 conjuntos de tornillos y tuercas



14  
PZAS

4.73 kg

### 9BE5158

769€<sup>B</sup>

#### CAJA CON EXTRACTOR DE INYECTOS

Todas las herramientas necesarias para la extracción rápida de los inyectores agarrotados sin dañarlos. Concebido para el desmontaje de los inyectores sin dañarlos. Brazos regulables en altura para compensar las irregularidades de apoyo. Para inyectores BOSCH; DELPHI y SIEMENS con doble fijaciones.



12  
PZAS

5.25 kg

### 9BA21

134€<sup>B</sup>

#### CAJA DE EXTRACCIÓN DESPEGADOR Y GUILLOTINA

CONTIENE:

- 1 guillotina
- 1 despegador 30~50 mm
- 2 tirantes (102 mm)
- 2 extensiones (102 mm)
- 1 despegador 50~75 mm
- 2 tirantes (127 mm)
- 2 extensiones (127 mm)
- 1 tornillo de presión 175 mm



Producto unido

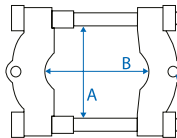

Producto unido



### 9BA120

329€<sup>B</sup>

#### DESPEGADOR PARA GUILLOTINA SERIE 9BA1100

Para una extracción con despegador, ideal para las poleas.

	B mm	A mm	Ø D mm	Guillotinas unidas	kg
9BA1206B	12 ~ 134	152	5/8"	9BA1110, 9BA1120	5.7

### 9BA220

172€<sup>B</sup>

#### DESPEGADOR PARA GUILLOTINA SERIE 9BA1100S

Pensado especialmente para las cajas de cambios y los accesos reducidos.

	B mm	A mm	Ø D mm	Guillotinas unidas	kg
9BA2204B	10 ~ 110	110	5/8"	9BA1110S	2.75

Producto unido

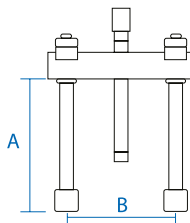
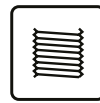
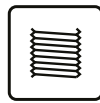

Producto unido



### 9BA11

#### GUILLOTINA PARA DESPEGADOR 2 GARRAS

Para una extracción con despegador, ideal para las poleas. Brazo corredero y extensible (opcional). Apriete rápido y preciso. Extracción posible por atornillamiento.

	B (máx.) mm	A mm	●/■ mm	Potencia T	Despegadores unidos	Roscado	kg	€
9BA1110	195	190	■ 14	10	9BA1204B, 9BA1206B	3/4"x16h	3.4	239€ <sup>B</sup>
9BA1120	325	255	■ 17	20	9BA1204B, 9BA1206B	1"x14h	9.5	459€ <sup>B</sup>

### 9BA11S

189€<sup>B</sup>

#### GUILLOTINA PARA DESPEGADOR AFINADO 2 GARRAS

Extracción por atornillamiento posible. Apriete rápido y preciso. Garras correderas. Para una extracción con despegador ideal para las cajas de cambios o los accesos reducidos.

	B mm	A mm	●/■ mm	Potencia T	kg
9BA1110S	62 ~ 195	175	■ 22	10	3.0



Extracción interior

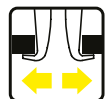
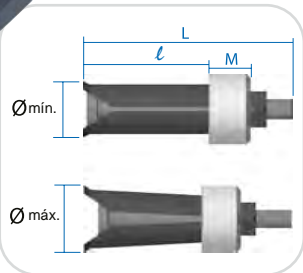

Extracción interior

Producto unido



9BE43

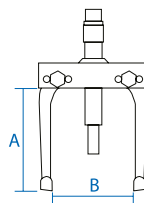

### 9BE43

#### EXTRACTORES DE PINZAS

Masa de inercia 9BA4390 y guillotina 9BA4392.

	Ø mm	M mm	l mm	L mm	Pinza sola	kg	
9BE4347	47 ~ 54	39	89	175	9BE434705	1.32	165€ <sup>B</sup>
9BE4355	55 ~ 64	39	89	175	9BE435505	1.58	197€ <sup>B</sup>
9BE4365	65 ~ 76	39	89	175	9BE436505	1.95	242€ <sup>B</sup>

### 9BA4392

#### GUILLOTINA PARA SERIE 9BE43

160€<sup>B</sup>

	B mm	A mm	mm	Roscado	kg
9BA4392	38 ~ 91	120	22	1/2" UNF 20h	1.5

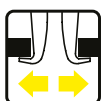

Extracción interior

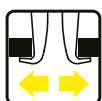

Extracción interior



9BE5681 18-22 84€<sup>B</sup>

9BE5683 28-32 171€<sup>B</sup>

#### EXTRACTORES DE RÓTULAS SOBRE EJE

Para una extracción de rótulas de dirección y de suspensión. Universal.

	C mm	A mm	B mm	mm	D mm	kg
9BE5681	18 ~ 22	97	50	19	25	700
9BE5683	28 ~ 32	155	95	30	30	2600

### 9BA4311

605€<sup>B</sup>

#### COFRE DE EXTRACCIÓN CON PINZAS Y GUILLOTINA

Para una extracción interior.

Contiene		kg
	9BE4300	3.5
	9BA4392	

### 9BA4322

795€<sup>B</sup>

#### COFRE DE EXTRACCIÓN CON PINZAS, GUILLOTINA Y MASA DE INERCIA

Para una extracción interior.

Contiene		kg
	9BE4300	5.2
	9BA4392	
	9BA4390	

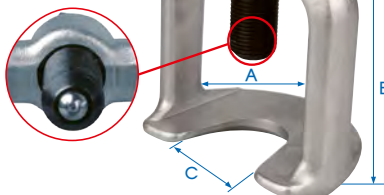
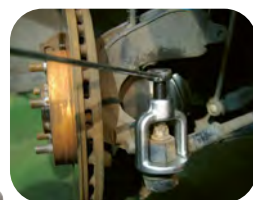
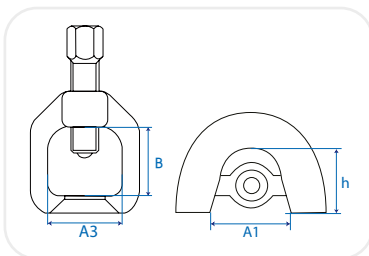

### 9BE5650

#### EXTRACTOR DE RÓTULAS DE ACCIÓN DIRECTA VEHÍCULOS PESADOS

Para una extracción de rótulas de dirección de presión directa.

	Par máx. Nm	B mm	A1 mm	A3 mm	h mm	Roscado	mm	kg	
9BE5655	320	80	55.6	79	51	M1/2"x14x111	22	2.1	162€ <sup>B</sup>
9BE5656	400	100	59	102	50	M1/2"x14x112	22	2.3	177€ <sup>B</sup>

### 9BE45

99€<sup>B</sup>

#### EXTRACTOR DE RÓTULAS DE ACCIÓN DIRECTA

Pensado para extraer el balancín de dirección y estabilizadores, las rótulas de dirección y otro tipo de rótulas.

	Par máx. Nm	A mm	B mm	C mm	mm		kg
9BE45	400	77	100	46	24	1/2" 14h	2.3



**New**



7960991



7960991B



7960991C

796099

**EXTRACTOR DE CHAVETAS**

Extractor de llaves de tación con cabeza. Fabricado con materiales robustos, este extractor está diseñado para resistir el uso intensivo y las condiciones exigentes del trabajo agrícola, garantizando una larga vida útil y un rendimiento constante. Su diseño curvado facilita el acceso a zonas de difícil acceso o mal posicionadas, minimizando el riesgo de dañar componentes delicados o lesionarse durante su manipulación. Anchura del asa: 89,5 mm

	l mm	L mm		
7960991	385	10	780	46€ <sup>B</sup>
7960991B	385	10	780	46€ <sup>B</sup>
7960991C	304	10	600	32€ <sup>B</sup>

**New**



1.046

9BE1950

189€<sup>B</sup>

**COFRE DE EXTRACTOR DE PASADORES ROSCADOS HEMBRA (M4 - M10)**

Contiene dos ejes para la barra de impacto y 4 adaptadores de M4, M-5, M-6, y M-8. La rosca M-10 se saca directamente sin adaptador. Para la extracción por inercia de pasadores roscados hembra.



2

9BE1960

319€<sup>B</sup>

**COFRE DE EXTRACTOR DE PASADORES ROSCADOS HEMBRA (M6 - M20)**

Extractor de pasadores roscados hembra con barra de impacto de 1 kg. Con 10 adaptadores de M6 a M20. Para la extracción por inercia de pasadores roscados hembra. 1 masa de inercia 9BA4390 : rosca 1/2" UNF 20h. 2 adaptadores: 3/8" + 5/8". 8 adaptadores: M6, M8, M10, M12, M14, M16, M18, M20.

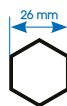

9HBE4

**EXTRACTOR DE ROTULAS REFORZADO CON ACCIÓN DIRECTA VP**

Se puede usar con una llave de impacto. Compatible con todos los camiones o vehículos. Fabricado para la extracción los balancines de dirección y estabilizadores, rotulas de dirección y otras rotulas.



	A mm	B mm		
9HBE439	39	95	2.32	179€ <sup>B</sup>
9HBE458	58	120	4.20	419€ <sup>B</sup>
9HBE462	62	120	4.20	419€ <sup>B</sup>
9HBE467	67	120	4.20	419€ <sup>B</sup>

3 PZAS



7.0

9HBE81

359€<sup>B</sup>

**EXTRACTOR HIDRÁULICO REFORZADO DE ROTULAS VP**

Extractor hidráulico reforzado de rótulas VP. Para una extracción de rótulas de dirección y de suspensión. Estructura reforzada. Suministrado con un tornillo manual y un tornillo hidráulico 12T. Ideal para los vehículos pesados, autobuses, los vehículos agrícolas y de obras públicas.



Apertura de las mandíbulas: 70 mm  
Ancho del alcance: 36 mm



5 PZAS



8.55

9HBE083

342€<sup>B</sup>

**EXTRACTOR HIDRÁULICO DE ROTULAS VP**

Extractor hidráulico de rótulas VP. Mandíbulas intercambiables 30 mm, 34 mm, 40 mm. Suministrado con un tornillo manual y un tornillo hidráulico 12T. Ideal para los vehículos pesados, autobuses, los vehículos agrícolas y de obras públicas.



Ancho del alcance: 30, 34, 40 mm





25  
PZAS

79

11225SQ

109€<sup>B</sup>

**COFRE DE EXTRACCIÓN DE ESPÁRRAGOS**

Para una extracción exterior  
Brocas a la derecha.

CONTIENE:

- 10 guías exteriores de M5 a M14
- 5 brocas a la derecha: 4, 5, 6, 7.5, 8.5 mm
- 5 pasadores de extracción
- 5 adaptadores hexagonales para pasadores

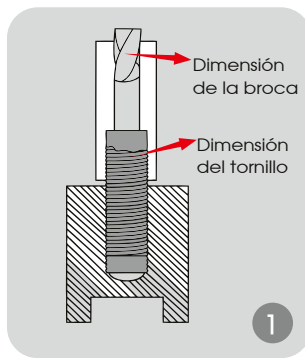

1

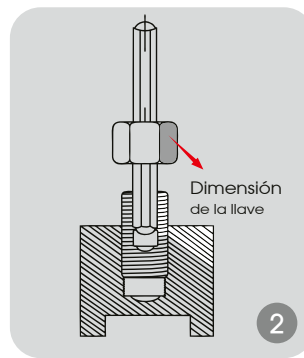

2



**New**

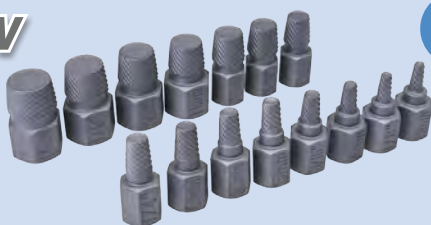

15  
PZAS

11015SQ

62€<sup>B</sup>

**JUEGO DE EXTRACTORES DE TORNILLOS**

Para retirar tornillos rotos, atascados o dañados.  
Para extraer pernos redondeados, dañados, rotos o atascados.  
Acero SNCM +V. Dureza: HRC 49-52.

Contiene

0.53

- 12 mm 1/8", 3/16", 1/4", 3/8", 3, 4, 5, 5.5, 6, 8, 10 mm
- 16 mm 1/2", 11, 12, 14 mm

Funcionamiento :

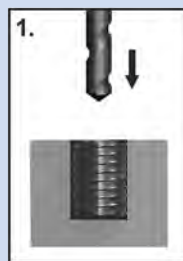

1. Taladre un orificio 0.5 mm mayor que el extractor en el perno.

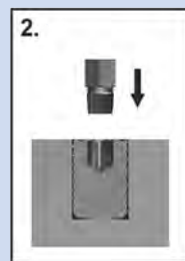

2. Inserte el extractor en el orificio.

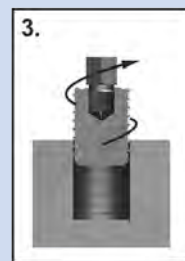

3. Gire en sentido contrario a las agujas del reloj para retirar el perno.



No utilice nunca estos extractores manuales con una herramienta bajo tensión, para evitar daños o lesiones.



6  
PZAS

82

11406SQ

16,50€<sup>B</sup>

**COFRE DE EXTRACTORES DE TORNILLOS DE DOBLE EXTREMO**

Para sacar tornillos dañados, rotos, oxidados, bloqueados. Utilizar con un taladro energizado. Perforar un agujero en un tornillo dañado y extraerlo usando el otro extremo del extractor. Contiene 6 extractores de 2 a 12 mm para adaptarse a las situaciones más comunes. Fabricados en HSS de alta dureza para perforaciones más fáciles y rápidas.

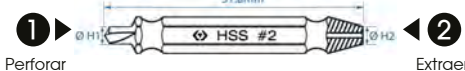

Contiene	Ø H1	Ø H2	
HSS #0	#0	2.5	2-3 mm
HSS #1	#1	3.0	3-5 mm
HSS #2	#2	3.5	4-8 mm
HSS #2	#2	3.5	4-8 mm
HSS #3	#3	4.0	5-10 mm
HSS #4	#4	6.0	6-12 mm



5  
PZAS

11205SQ

13€<sup>B</sup>

**JUEGO DE 5 EXTRACTORES DE ESPÁRRAGOS CÓNICOS**

Para una extracción de espárragos interiores.

Contiene 103

- 9BE2127 M3~M6, M6~M8, M8~M11, M11~M14, M14~M18

Para usar con: 3912M

3911ML

3740ML



Cilindros especiales que permiten seguir paso a paso la extracción.



34 PZAS

12.9

9BE5198

799€<sup>B</sup>

**COFRE EXTRACTORES DE SILENT-BLOCS**

Útil para el montaje y el desmontaje de los silent-blocs, rodamientos y rótulas. No necesita prensa hidráulica.

CONTIENE:

- Husillos roscados de 340 mm (M10, M12, M14, M16)
- Cilindros: Øint 34-72 mm, Øext 44-82 mm
- Casquillos: Ø 34-72 mm



22 PZAS

2.45

9DA022

112€<sup>B</sup>

**COFRE DE EXTRACTORES PARA POLEAS DE ALTERNADOR**

Utilizado para colocar y quitar las poleas de alternador. Pensado para alternadores: Bosch, Valeo, Magneti Marelli, Denso. Compatible también con VW, Audi, Citroën/Peugeot, Mercedes, Renault, BMW, Fiat, Ford, Toyota.



4 PZAS

1.89

9TD064

79€<sup>B</sup>

**JUEGO DE ROMPE-TUERCAS**

Para extraer las tuercas rotas o demasiado apretadas sin deteriorar la barra roscada. Este juego vale para tuercas con clase de fuerza de tracción número 6.

Contiene



- 9TD601 (9-12 mm)
- 9TD602 (12-16 mm)
- 9TD603 (16-22 mm)
- 9TD604 (22-27 mm)



Vaso diseñado para pernos usados o redondeados por el tiempo. Vasos de SNCM (Silicium Nickel Chrome Molibdeno).

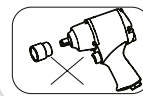

⚠ No utilizar los vasos con una llave de impacto.



4 PZAS



9TD164MR 1/2"

97€<sup>B</sup>

**COFRE DE VASOS LARGOS HELICOIDALES 1/2"**

Largo de los vasos: 146mm  
Barra de extracción de tornillos dañados de 12 x 160mm. Después de la extracción del tornillo dañado, si se queda bloqueado en el vaso, usar la barra de extracción para expulsarlo.

Contiene

1.36

9TD406 17, 19, 21 mm

7641206P



3 PZAS

9TD033MR 1/2"

50€<sup>B</sup>

**COMPOSICIÓN DE VASOS HELICOIDALES 1/2" SOBRE RÁIL**

Contiene

400

9TD403 17, 19, 21 mm

# MECÁNICA

## CARBURANTE



312 g

**9AB11**

33 €<sup>B</sup>

### ALICATE PARA MANGUITOS DE CARBURANTE

Para quitar y reemplazar las conexiones de carburante. Para: VW-Audi, Fiat, GM, Opel/Vauxhall, Mercedes-Benz.

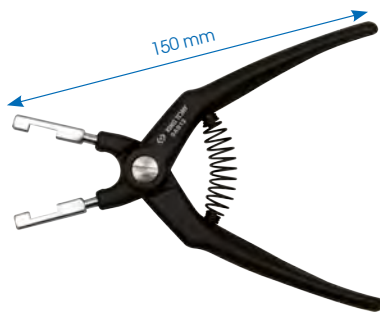

87 g

**9AB12**

26 €<sup>B</sup>

### ALICATE PARA MANGUITOS DE CARBURANTE

Para quitar y reemplazar las conexiones de carburante. Para: VW, PSA, Fiat, Opel.

## ACCESORIOS



203 g

**9TQ02**

32 €<sup>B</sup>

### DEDO MAGNÉTICO FLEXIBLE CON LED 3 EN 1



1 Para recoger pernos y tuercas difíciles de alcanzar.

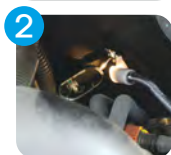

2 Espejo de inspección: 50 x 25 mm. Para inspeccionar áreas ocultas o estrechas. Espejo giratorio de doble rótula.

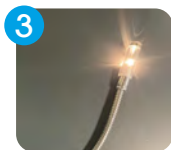

3 Cabezal con luz  
2x AA no incluidas

**New**

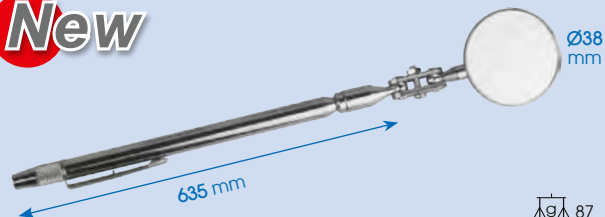

87 g

**9TQ21**

10,40 €<sup>B</sup>

### DEDO MAGNÉTICO TELESCÓPICO 3 EN 1



1 600 g de potencia magnética.



2 Espejo de inspección de 38 mm de diámetro para inspeccionar zonas ocultas o estrechas. Espejo giratorio con doble rótula para una visión de 360°.



3 Aguja para limpiar la salida de la boquilla del limpiaparabrisas.

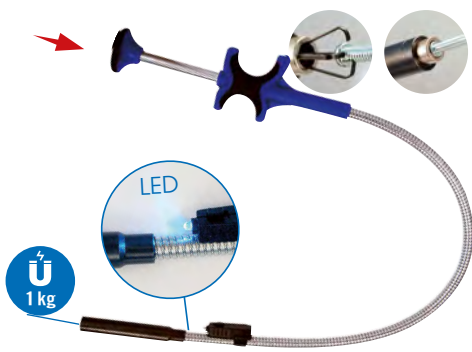

3x LR521

280 g

**212924**

39 €<sup>B</sup>

### DEDO MAGNÉTICO CON LED

3 en 1 con un imán, un gancho y una lámpara LED. Magnetización muy potente. Acabado compacto y ergonómico para un mejor agarre. Batería de litio: LR521x3.

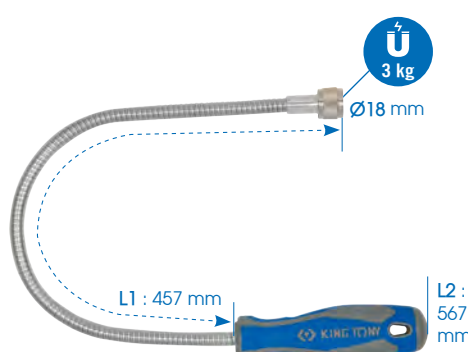

250 g

**2121A18**

22 €<sup>B</sup>

### DEDO MAGNÉTICO

Vástago metálico flexible. Resistencia a las agresiones químicas y petrolíferas.

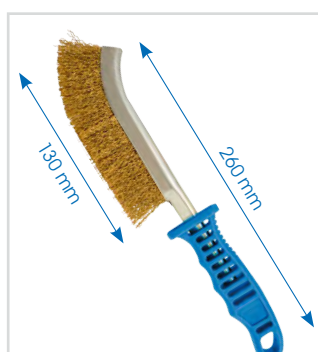

130 g

**9CZ201**

4 €<sup>B</sup>

### CEPILLO METÁLICO CURVADO - ALAMBRE DE ACERO ONDULADO

Para trabajos de cepillado como desbarbado, limpieza, desenganche, alisado, y requiere flexibilidad.

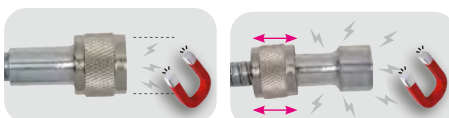
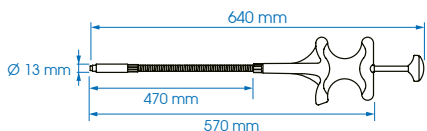



130 kg  
↓

5.0

**87C23AB**

59 €<sup>B</sup>

**CAMILLA DE MECÁNICO DE PLÁSTICO**

Práctico con empuñadura de transporte y dos espacios de almacenaje en los laterales para un alcance rápido a tus herramientas. Reposacabezas de espuma recubierto de vinilo para mayor comodidad. 6 ruedas giratorias. 102 cm (40"). Resistente: diseño de plástico monobloc. Distancia al suelo: 1/4" (6.35 mm).



85

**9DD21**

8 €<sup>B</sup>

**DENSÍMETRO ÁCIDOS DE BATERÍA**

Lectura rápida de la concentración de ácido dentro de la batería (en g/L). Permite saber el estado de carga de la batería. Comprueba tensiones de 6V, 12V y 24V.

**New**



126

**9TG11**

27 €<sup>B</sup>

**ALFOMBRA DE PROTECCIÓN PARA RODILLAS**

Resiste a los aceites y productos químicos. Permite quedarse arrodillado con más comodidad. Alfombra antifatiga para las rodillas.



**New**

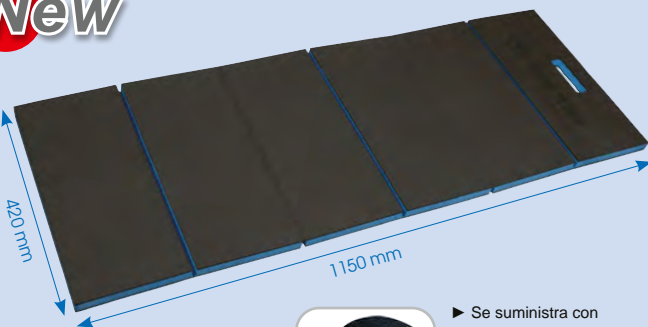

991

**9TG22**

61 €<sup>B</sup>

**ALFOMBRA DE PROTECCIÓN**

Esterilla plegable para que los mecánicos trabajen sentados / arrodillados y tumbados. Se suministra con correas; se puede plegar y atar para guardarla cómodamente. Resiste a los aceites y productos químicos.



New

87H32AB

67€<sup>B</sup>

**TABURETE DE TALLER AJUSTABLE**

- Materiales: cuero de PVC + relleno de espuma + base de plástico PP.
- 4 bases de plástico desmontables: 185 x 212 x 34 mm (una magnética).

Dimensiones (mm)	
430 x 430 x 400	4.8



► 1 base magnética



► Cuatro ruedas giratorias de 360°.



- Marco de plástico extraíble para mantener las herramientas y piezas pequeñas al alcance de la mano.



- Altura del asiento regulable de 400 a 540 mm, para evitar agacharse, arrodillarse o ponerse en cuclillas.



- Asiento suave al tacto de piel sintética impermeable de 50 mm de grosor.

New

87C26AB

79€<sup>B</sup>

**TABURETE CONVERTIBLE EN CAMILLA**

- Cómodo asiento con cojín de espuma.
- 6 ruedas giratorias para una movilidad perfecta.
- Gran cojín recubierto de vinilo para mayor comodidad al trabajar.
- Bastidor totalmente de acero para una estructura más resistente y duradera.

Dimensiones (mm)	
1020 x 430 x 135	8.9



- Se convierte de taburete a camilla con un simple movimiento.



- Ruedas giratorias de 360 grados, que permiten girar sin ángulos muertos.



- El cojín del asiento es de espuma gruesa, suave y confortable, que evita la fatiga incluso tras largos periodos sentado.

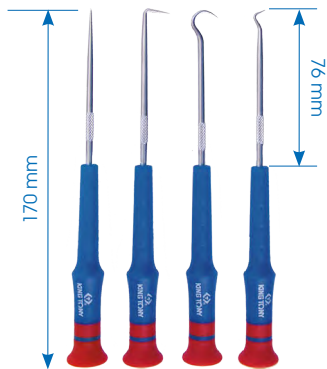

4  
PZAS

70

**30914AY** 13,80€<sup>B</sup>

**JUEGO DE GANCHOS DE PRECIÓN**

Para trazar, alinear, instalar y retirar juntas tóricas, juntas de estanqueidad, pernos agrietados y arandelas.



4  
PZAS

420

**930904AY** 27€<sup>B</sup>

**JUEGO DE RASCADORES EN GANCHO**

4 tipo de cuchilla: curvado, gancho, L 90°, plano. Empuñadura 2 materiales PP+TPR. Acabado cromado pulido.

**LUBRICACIÓN**



1.36

**9BU1432T** 400 cc 51€<sup>B</sup>

**BOMBA DE ENGRASE CON EMPUÑADURA**

Capacidad 400 cc. Presión de trabajo: 310 bares (máximo 490 bares). Boquilla metálica fija y latiguillo flexible. Empuñadura cómoda. Largo: 267 mm.



1.24

**9BU241T** 400 cc 44€<sup>B</sup>

**BOMBA DE ENGRASE CON PALANCA**

Capacidad: 400 cc. Presión de trabajo: 310 bares (máximo 700 bares). Boca fija metálica y tubo flexible. Largo: 360 mm.



770

**9BT250** 500 cc 31€<sup>B</sup>

**BOMBA DE ENGRASE CON EMPUÑADURA**

Capacidad 500 cc. Latiguillo flexible. Permite cambiar el aceite, vaciar las cubas o los depósitos, en todos los campos. Largo: 340 mm.



505.2

**9BU41** 42€<sup>B</sup>

**ENGRASADOR DE RODAMIENTOS PORTÁTIL**

Permite engrasar fácilmente los rodamientos de bolas. Compatible con rodamientos de hasta 89 mm de diámetro. Apriete el mango hasta que se elimine toda la grasa usada y se reemplace con grasa nueva.

**9TB ACEITERAS**

Modelo	Capacidad cc.	Peso g	
9TB225	225	103	11€ <sup>B</sup>
9TB500	500	302	14€ <sup>B</sup>

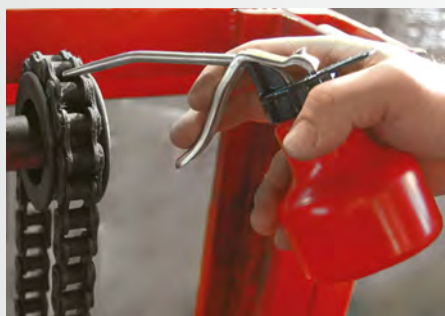

## CAMBIO DE ACEITE - FILTRACIÓN

**New**

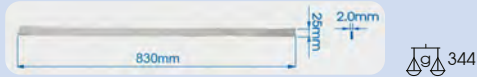

**32067A** Ø60~180 34,50€<sup>B</sup>

### LLAVE DE FLEJE PARA FILTRO DE ACEITE

Capacidad : 60~180 mm. Largo : 279 mm.  
Largo del fleje : 830mm. Adecuado para filtros de aceite y cualquier tipo de tubería. Fleje de nylon con alta resistencia para un mejor agarre. Empuñadura con aleación de aluminio.

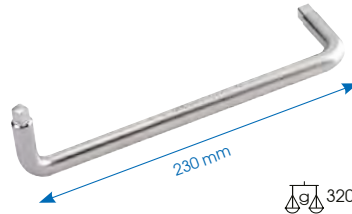

**158609** 5,90€<sup>B</sup>

### LLAVE PARA TAPONES DE DRENAJE

Dimensiones de 8 a 10 mm.  
Acabado cromado.

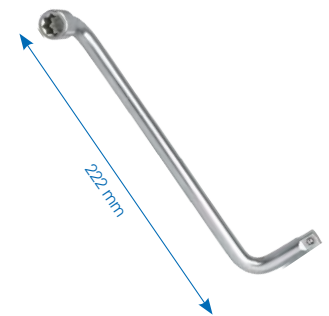

**159609** 8,20€<sup>B</sup>

### LLAVE PARA TAPONES DE DRENAJE

Llave para cambio de aceite  
8 caras 10 mm Volkswagen.  
Ancho 61 mm. Acabado cromado.



**9AE31**

### LLAVE DE FLEJE PARA FILTRO DE ACEITE

Mango PVC abatible para espacios reducidos

Capacidad (mm)

	Capacidad (mm)		
<b>9AE31111</b>	95~111	307.8	13 € <sup>B</sup>
<b>9AE31121</b>	110~121	400.0	14 € <sup>B</sup>
<b>9AE31134</b>	120~134	400.0	14 € <sup>B</sup>
<b>9AE3173</b>	60~73	273.4	12 € <sup>B</sup>
<b>9AE3185</b>	73~85	283.0	12 € <sup>B</sup>
<b>9AE3195</b>	85~95	302.4	13 € <sup>B</sup>



1,9 kg

**9AE5001GM** Ø110~142 275€<sup>B</sup>

### LLAVE AUTO APRIETE MAGNÉTICA

Acabado y protección antioxidante  
9AE5001RF : especial RENAULT y VOLVO, resistencia 350 Nm, hexágono de arrastre fijo



603.5 kg

**9AE43** Ø75~120 26€<sup>B</sup>

### LLAVE AUTO APRIETE

Cuadrado de arrastre 3/8". Adaptador 1/2" x 3/8".  
Estructura reforzada.



CANTIDAD LIMITADA

20 kg

**9AR21** 9,80€<sup>B</sup>

### LLAVE PARA TAPONES DE DRENAJE

Para instalar o quitar tapones de plástico de drenaje en los últimos modelos de vehículos VAG.



1/2"

**9AE52** Ø60~80 72€<sup>B</sup> 470 kg

**9AE52110** Ø80~110 113€<sup>B</sup> 985 kg

### LLAVES DE AUTO APRIETE

Cuadrado de arrastre 1/2". Acabado y protección antioxidante.



### LLAVES DE FLEJE METÁLICO PARA FILTRO DE ACEITE

**9AE32110** 13€<sup>B</sup>

Ø65~110 450 kg

**9AE32155** 15€<sup>B</sup>

Ø110~155 455 kg





6 PZAS



1/2"



359

3204 Ø60~140 19€<sup>B</sup>

**LLAVE DE CADENA PARA FILTRO DE ACEITE**  
Largo: 225 mm.



975

320560 Ø60~160 59€<sup>B</sup>

**LLAVE DE DOBLE CADENA PARA FILTRO DE ACEITE**

Mango flexible para los accesos difíciles.  
Apertura de la cadena con una simple presión de la cabeza.

3209120 Ø60~120 27€<sup>B</sup>

3209135 Ø60~135 28€<sup>B</sup>

3209220 Ø60~220 33€<sup>B</sup>

**TOMA DE CADENA DE 1/2" PARA FILTRO DE ACEITE**

Adecuado para extraer todo tipo de filtros de aceite de vehículos. Cadena diseñada para facilitar la extracción de filtros de aceite difíciles. Fácil de usar con una carraca de 1/2.



3716MR 3/8" 88€<sup>B</sup>

**CAJA DE VASOS ARTICULADOS 3/8" PARA BUJÍAS**

Para bujía de motor diesel. Vaso equipado de una bola de retención para sujetar la bujía.

Contiene

1.23



3785M

8, 9, 10, 12, 14, 16

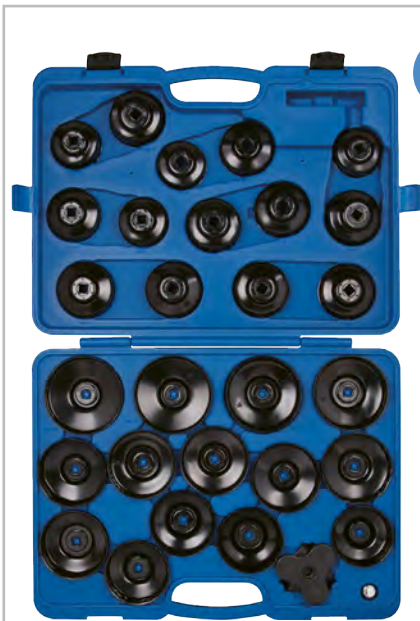

30 PZAS

3/8"

1/2"

6.5

9AE6030 Ø65~120 189€<sup>B</sup>

**COFRE DE LLAVES CAZOLETA PARA FILTRO DE ACEITE**

Cofre universal.

- 1 llave autoregurable 9AE42 (de 65 hasta 120 mm)
- 1 adaptador 1/2"H x 3/8"M
- 28 llaves para filtro (de 65 hasta 108 mm) cuadrado conductor 1/2"



21 PZAS



9AR11 66€<sup>B</sup>

**COFRE DE LLAVES PARA CARTER**

Útil para carter de cambio de aceite, caja de cambios y eje trasero.

Contiene

1.7

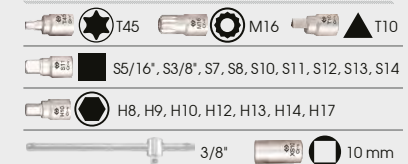

3L

390

9TT2103 16.60€<sup>B</sup>

**BANDEJA RECOGEDORA DE ACEITE EN CUBOS DE RUEDA DE CAMIÓN**



18L

920

9TT1118 17.60€<sup>B</sup>

**BANDEJA RECOGEDORA DE ACEITE**

Borde antisalpicaduras que impide el desbordamiento. No se puede utilizar con pistola de limpieza o de pulverizar.



## TREN DELANTERO



**9BE5**

### HERRAMIENTA DE AUTO APRIETE PARA RÓTULAS AXIALES

Útil para soltar y cambiar las rótulas axiales de dirección sin quitar las cremalleras. Permite desunir la rótula del balancín para cambiar la orientación de la dirección. Arrastre hexagonal.

Capacidad (∅mm) Largo (mm)

<b>New</b>	<b>9BE51</b>	28-35	400	1635	99 €	B
	<b>9BE52</b>	35-45	400	2140	119 €	B



**9BE6**

### HERRAMIENTAS DE DESBLOQUEO DE LA RÓTULA AXIAL DE DIRECCIÓN

Útil para soltar y cambiar las rótulas axiales de dirección sin quitar la cremallera. Interior dentado para un enganche perfecto. Se utiliza con las carracas y las extensiones 1/2". Conviene para la mayoría de los vehículos pesados.

Capacidad (∅mm) Largo (mm)

<b>9BE62</b>	33-42	81.50	370	65 €	B
<b>9BE63</b>	42-50	87.56	403	72 €	B



## RUEDAS



20 PZAS

### COFRE DE VASOS PARA TUERCAS ANTIRROBO

Este cofre permite a los mecánicos profesionales mantener ruedas equipadas con tuercas antirrobo. De cromo-molibdeno (CrMo). Acabado: aleación de acero cromado. Accionamiento hexagonal de 17 mm

CANTIDAD LIMITADA

**9BW0120 VW 229 €<sup>B</sup>**

Permite instalar y retirar las tuercas antirrobo de la mayoría de los modelos VW.

Contiene 2.9

#521, #522, #523, #524, #525, #526, #527, #528, #529, #530, #531, #532, #533, #534, #535, #536, #537, #538, #539, #540

CANTIDAD LIMITADA

**9BW0220 BMW 214 €<sup>B</sup>**

Permite instalar y retirar las tuercas antirrobo de la mayoría de los modelos BMW.

Contiene 1.94

#041, #042, #043, #044, #045, #046, #047, #048, #049, #050, #051, #052, #053, #054, #055, #056, #057, #058, #059, #060



1 AÑO GARANTÍA



20 mm  
146 mm  
185 mm

**9BM2210A**

86 €<sup>B</sup>

### INFLADOR PARA NEUMÁTICOS 3 EN 1

Manómetro de membrana. Precisión: ANSI B401.1. Caja de caucho para proteger el manómetro de los golpes. 3 funciones en la empuñadura: comprobar la presión, deshinchar, inflar. Flexible de caucho de 400 mm para presión alta. Mandril de aire estándar adaptado para coches. Mandril de aire largo para válvulas con difícil acceso: adaptado para camiones, autobuses y tractores. Rango de presión: 0-15 Bares (0-220 PSI). Con gancho integrado. Entrada de aire: 1/4". Manguera de aire: 3/8". 600 g.



**3488A03MP**

154 €<sup>B</sup>

### MULTIPLICADOR DE FUERZA 47:1

Ideal para el aflojamiento de las tuercas de ruedas de vehículos pesados, autobuses, de vehículos agrícolas y de obras públicas. Multiplicador de fuerza manual. Compacto, robusto y para uso profesional. Con vasos de impacto hexagonales 1" (32 y 33 mm). Ratio 47:1. Par máximo aplicado 4700 Nm.

342 x 168 x 94 mm



### 9BA12

#### HERRAMIENTA DE INSTALACIÓN DE JUNTAS

Diseñado para adaptarse a los retenes del eje sin dañarlos. Utilícelo con un mazo de goma.

	Ø (mm)	Compatible con		
9BA12165	165	Mercedes-Benz Actros FA	222	119 € B
9BA12175	175	Mercedes Actros AP Eje trasero	191	139 € B
9BA12187	187	Mercedes-Benz Actros FA	253	154 € B
9BA12208	208	Mercedes-Benz, MAN, DAF	378	219 € B

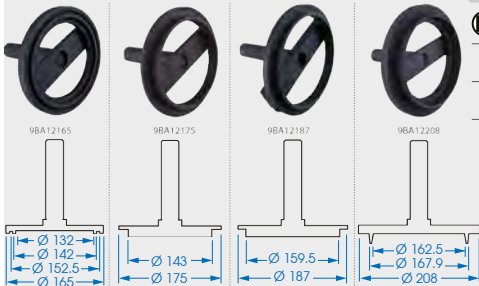

8 PZAS

### 9BK7008

#### CEPILLOS TERMOFORMADOS PARA LIMPIEZA DE ESPÁRRAGOS

Para limpiar fácilmente la corrosión de espárragos de 12 a 28 mm. Incluye seis cepillos, un mango para sujetar cepillos y discos de lija de 1/2" y un adaptador para destornillador de 1/2". Cambio de cepillo rápido y sencillo en mango de 1/2". Se puede utilizar con un atornillador o una llave de impacto de 1/2".

57 € B

Contiene			
	1/4" 770 1/2"	770450	
	9BK711 1/2"		
	9BK72	12, 13, 14, 16, 22, 28	



8 PZAS

### 9BK7009

#### CEPILLOS TERMOFORMADOS Y DISCOS ABRASIVOS PARA LA LIMPIEZA DE ESPÁRRAGOS Y BUJES

Para una limpieza rápida y fácil de la corrosión de espárragos y cubos de 14 y 22 mm. Se coloca sobre los espárragos de cubo para limpiar su superficie en toda su longitud. Limpia también el resto del cubo entre los espárragos. Incluye dos cepillos, cuatro discos lijadores, mango de 1/2" para cepillo y disco lijador y adaptador para destornillador de 1/2". Cambio de cepillo rápido y sencillo en mango de 1/2". Se puede utilizar con un atornillador o una llave de impacto de 1/2".

63 € B

Contiene			
	1/4" 770 1/2"	770450	
	9BK711 1/2"		
	9BK72	12, 22	
	9BK73	14x2, 22x2	



### 9BK4153

#### DESMONTA NEUMÁTICOS

21 € B

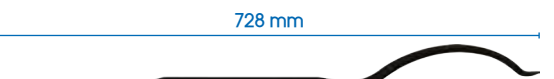

### 9BK4173

#### DESMONTA NEUMÁTICOS - ESPECIAL VEHÍCULOS PESADOS

96 € B



### 9BK11

#### ALICATE PARA CONTRAPESOS DE RUEDAS

420

20 € B



11 PZAS

### 9BK51E

#### KIT DE REPARACIÓN PARA EL CONTROL AUTOMÁTICO DE PRESIÓN DE NEUMÁTICOS (TPMS)

Kit completo de apriete controlado para tuercas de válvulas y tornillos de Snap-in. Para ayudar en la instalación/cambio del sensor TPMS y la válvula del neumático. Conforme con la norma DIN ISO 6789 & ASME B107.14M2004.

99 € B

Contiene			
	2235M 1/4" 11, 12, 13		
	2033 1/4" T10, T15, T20		
	342113DG		341214M
	34101040M		275245G
	222104		

## EMBRAGUE



3  
PZAS

9AK11

18 €<sup>B</sup>

### CENTRADOR DE EMBRAGUE UNIVERSAL

Centra y mantiene el disco al igual que su mecanismo de embrague. Suministrado con 3 alicates.

Capacidad: 15,5-27 mm.

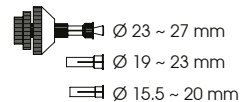

190

## SUSPENSIÓN

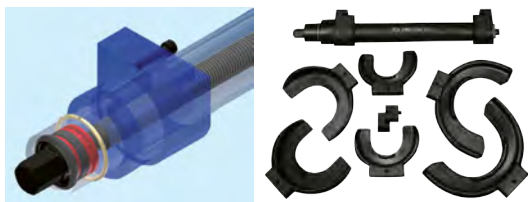

8  
PZAS

Ø 110-150 mm    Ø 80-115 mm    Ø 140-195 mm

15

9BF31

599 €<sup>B</sup>

### COFRE DE COMPRESORES DE MUELLE DE AMORTIGUADORES

Diseñado para las suspensiones Macpherson, suministrado con 3 copelas monobloc intercambiables. Par máximo: 350 Nm. Potencia de compresión: 450 kg / 4410 Nm. Apertura máxima: 40-300 mm. Largo: 460 mm.

Compatible con: BMW, Ford, VW, Audi, Porsche, Saab, Opel, Volvo, Nissan, Honda, Mitsubishi, Subaru, Toyota.

## SONDA LAMBDA



7  
PZAS

9AJ017 3/8"+1/2"

94 €<sup>B</sup>

### COFRE DE VASOS PARA SONDA LAMBDA

Vasos especiales para quitar la sonda lambda, inyectores y termocontacto de radiadores. Compatible con la mayoría de vehículos: Volkswagen, BMW, PSA, Mercedes-Benz, Ford, etc...

3/8"	27 mm	1/2"	29 mm
3/8"	22 mm	1/2"	27 mm
3/8"	22 mm	1/2"	22 mm
3/8"	22 mm		

2.13

New

4  
PZAS



190 x 60 x 48 mm

9AJ014

94 €<sup>B</sup>

### JUEGO DE TOMAS EXTRA CORTAS PARA SENSOR LAMBDA

Tomas para sensor de temperatura, sensor NOX y sensor de partículas. Enchufe extracorto para utilizar en lugares de difícil acceso.

Contiene

0.96

	9AJA0		30 mm	20, 22, 24 mm
	4935M		1/2"	30 mm

# MOTOR



IP67 (solo para objetivo/tubo)

740

**9TQ11**

169€<sup>B</sup>

## VIDEOSCOPIO PORTÁTIL PARA MECÁNICO

Lente de 5,5 mm con 6 LED, se puede utilizar para capturar vídeo o fotografía (cámara HD 1080p, resolución 1920 x 1080). Adecuado para la inspección visual de zonas de difícil acceso a larga distancia. Longitud de la manguera de la cámara 1050 mm. Pantalla LCD de 4,3 pulgadas con resolución 1080P. Batería recargable : 2600mAh Li-Ion. Autonomía : 3 horas sin interrupción. Tiempo de carga: 4 horas con el cable USB.

**9TQ11P02**

78€<sup>B</sup>



## CÁMERA DE INSPECCIÓN 3.9 MM PARA 9TQ11

Lente de 3,9 mm con 6 LED, se puede utilizar para capturar vídeo o fotografía (cámara HD 1080p, resolución 1920 x 1080)



IP67 (solo para objetivo/tubo)

331

**9TQ12**

68€<sup>B</sup>

## VIDEOSCOPIO WIFI PARA MECÁNICO

Antes de usar, descargue la aplicación inskam, que se puede utilizar en IOS y Android. Lente de 5,5 mm con 6 LED, se puede utilizar para capturar vídeo o fotografía (cámara HD 1080p, resolución 1920 x 1080). Adecuado para la inspección visual de zonas de difícil acceso a larga distancia. Batería recargable : 1700mAh Li-Ion. Autonomía : 2-3 horas sin interrupción.



1.43

**9AT3A04**

89€<sup>B</sup>

## EXTRACTOR DEL PIÑÓN DEL ÁRBOL DE LEVAS

Sirve para sujetar y extraer el piñón del árbol de levas sin dañarlo. Para utilizar con una carraca de 3/8" o una llave de 19 mm. Apto para la mayoría de piñones de Ø60 a Ø100 mm.

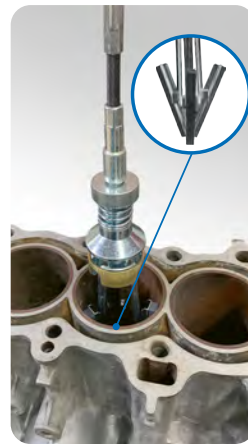

700

**9AC23154**

38€<sup>B</sup>

## BRUÑIDOR DE CILINDROS

Para el rodaje y pulido de cilindros motor de 50 mm a 175 mm. Fácil ajuste de la tensión del muelle. Piedra de rodaje fácil de cambiar. Piedra de rodaje de grano medio 220.



**11 PZAS**

3.7

**99AA01E**

#6

298€<sup>B</sup>

## BANDEJA EVAWAVE ALICATES Y DESTORNILLADORES

Contiene

	1453	05, 06, 07, 08, 10 mm
	9AA13	
	9AA17	
	9AA25	
	9AA16	
	9AA21	
	9AA31	



Para



220 mm

**9AA11**

20.80€<sup>B</sup>

**ALICATE PLANO PARA ABRAZADERAS AUTOAJUSTABLES**

Las mordazas giratorias partidas están pensadas para colocar y quitar las abrazaderas autoajustables. Compatible VW, AUDI

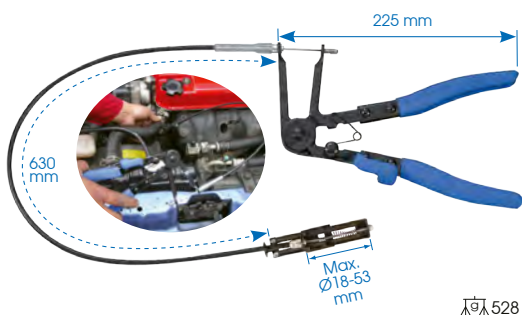

225 mm

**9AA31**

69€<sup>B</sup>

**ALICATE PARA ABRAZADERAS AUTOAJUSTABLES**

Flexible de 630 mm. Para los accesos difíciles. Para la instalación de abrazaderas.

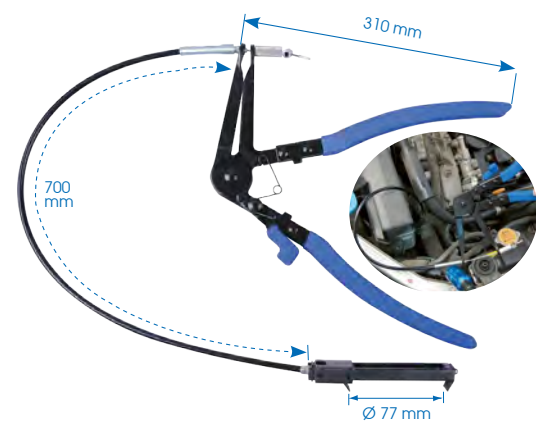

310 mm

**9AA32**

95€<sup>B</sup>

**ALICATE PARA ABRAZADERAS AUTOAJUSTABLES**

Flexible de 700 mm. Para la instalación de abrazaderas. Cabeza fina para los accesos difíciles. Adecuado para coches universales, especialmente VW, Ford, Nissan.



300 mm

**9BP21**

36€<sup>B</sup>

**ALICATE PARA ABRAZADERAS DE ESCAPE**

Adecuado para Citroën / Peugeot. Alicate con mecanismo de bloqueo en posición abierta.

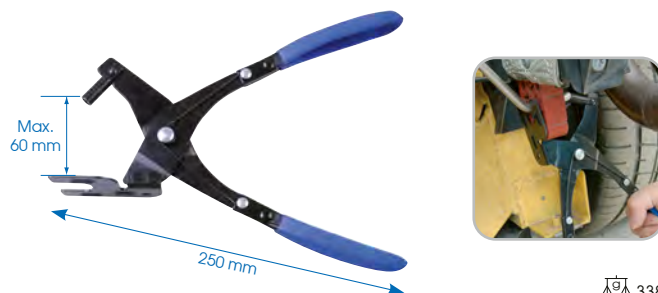

250 mm

**9BP11**

23€<sup>B</sup>

**ALICATE PARA SILENT-BLOC DE ESCAPE**

Alicate para quitar los soportes de goma de las líneas de escape. Para todos los vehículos.

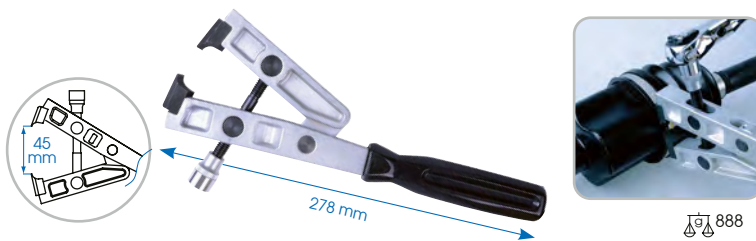

278 mm

**9BB13**

76€<sup>B</sup>

**ALICATE PARA ABRAZADERAS DE FUELLE**

Alicate para abrazaderas de apriete sobre acero inox del árbol de transmisión (cardán). Se puede utilizar con una llave dinamométrica de 3/8". Para Audi, VW, Ford y Opel.

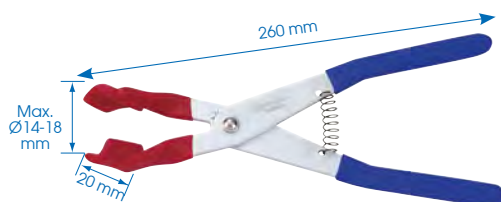

260 mm

**9DB201**

17€<sup>B</sup>

**ALICATE PARA EL CABLE DE LA BUJÍA**

Extracción de los hilos de las bujías. Cabeza enfundada para la protección de cables y bornes. Mango PP.



Disponible en abril

New

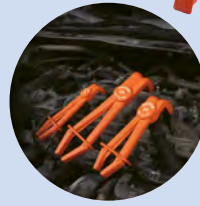

3 PZAS

270

9AF123

25 €<sup>B</sup>

### JUEGO DE ALICATES PARA MANGUITOS - 3 PIEZAS

Mandíbulas regulables para no estropear los manguitos. Para los manguitos de 17, 25 hasta 42 mm. Para bloquear los manguitos de radiadores, calefacción, carburantes, líquido de enfriamiento y de frenos. Mordazas en ángulo para facilitar el acceso a espacios reducidos.

Contiene



9AF12



17, 25, 42 mm



Ø 65.2 mm

Ø 35.4 mm

Ø 22.4 mm

3 PZAS

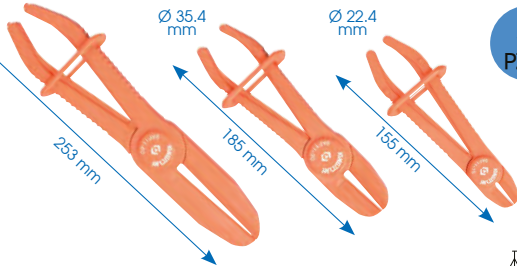

244

9AF113

21 €<sup>B</sup>

### JUEGO DE ALICATES PARA MANGUITOS - 3 PIEZAS

Mandíbulas regulables para no estropear los manguitos. Para los manguitos de 15 hasta 60 mm. Para bloquear los manguitos de radiadores, calefacción, carburantes, líquido de enfriamiento y de frenos.

New



60

9AL31

12 €<sup>B</sup>

### HERRAMIENTA DE MONTAJE DE CORREA PSA

Diseñado para instalar correas elásticas en bombas de agua. El material de fibra de nailon evita daños en los componentes durante el uso. Compatible con vehículos del Grupo PSA y motores Vauxhall/Opel 1.0 L y 1.2 L de 3 cilindros fabricados desde 2012.



Marca y tipo de vehículo

9AL31

18

2-3/4"

69

Citroën : Berlingo, C1, C3, C3 Picasso, C3 Aircross, C4, C4 Picasso, C4 Cactus, C-Elysee, DS3, DS4, DS4S and DS5LS.  
Peugeot : 108, 208, 301, 308, 408, 2008, 3008, 5008 Partner.  
Vauxhall/Opel : Crossland X.



## PARABRISAS



456

9CW01

61 €<sup>B</sup>

### JUEGO DE HERRAMIENTAS PARA QUITAR PARABRISAS

Diseñado para cortar las juntas del parabrisas.

CONTIENE:

- A - Punzón perforador
- B - Dos asas de agarre de alambre
- C - Alambre - 22 metros



351

9CW22

20 €<sup>B</sup>

### VENTOSA PARA PARABRISAS

Levanta hasta 40kg en posición horizontal. Ventosa de goma de 120 mm para una adherencia óptima que permite evitar daños en la superficie levantada. Para el mantenimiento de vidrios y chapas.

## REFRIGERACIÓN



Funciona sin adaptadores, gracias al cono de goma que se ajusta perfectamente con todos los diámetros de 17 a 40 mm.

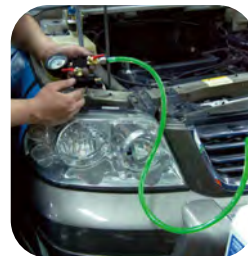

Permite un cambio rápido del líquido de enfriamiento al vacío.

3.4

9AM012

349 €<sup>B</sup>

### KIT UNIVERSAL PARA COMPROBAR LA PRESIÓN DEL CIRCUITO DE REFRIGERACIÓN

Para comprobar las pérdidas en los radiadores. Diseño profesional, que resiste a altas presiones. Ganchos especiales para manguitos, para un cambio rápido.

Para los vehículos universales: MB, GM, Jeep, Peugeot, Subaru, Chrysler, Acura, Mitsubishi, Nissan, Mazda, Toyota, Infiniti, Suzuki, Isuzu, Honda, Acura, Lexus, Volvo, Saab, Citroen, Renault, Fiat, Alfa, Mini Cooper, VW, BMW, Ford, Opel, Porsche, Audi, etc...

## BUJÍAS



356



9AC

### CEÑIDOR DE SEGMENTOS

Reglaje progresivo por compresión uniforme del pistón. Chapa de acero con resorte. Suministrado con una llave Allen hexagonal de 6mm.

Capacidad (mm)    Alto H (mm)

	Capacidad (mm)	Alto H (mm)		
9AC12532	57~125	80	260	16 € <sup>B</sup>
9AC12540	57~125	100	280	16 € <sup>B</sup>
9AC17532	90~175	80	300	16 € <sup>B</sup>
9AC17540	90~175	100	320	16 € <sup>B</sup>
9AC17566	90~175	165	530	32 € <sup>B</sup>

9DM1A1

135 x 78 x 33 mm

3.5~24V

85 €<sup>B</sup>

### COMPROBADOR DE BUJÍAS DE PRECALENTAMIENTO

Para las bujías de precalentamiento de acero y de cerámica 3.5, 4.4, 5, 7, 8.5, 10, 11, 24 V. Pantalla LCD. Protección contra corto circuitos y carga inversa. Parada automática: 110 segundos.



1x

incluida

## FRENOS



6 PZAS



0.73

9BC5001MR

117 €<sup>B</sup>

### JUEGO DE LLAVES PARA PURGA DE FRENOS

Dimensiones de las llaves: 7, 8, 9, 10, 11 mm. Ideal para sangrar el sistema de frenos y el sistema de embrague hidráulico sin desmontar las ruedas. Estanqueidad interna de material de alta calidad para mejorar la durabilidad.

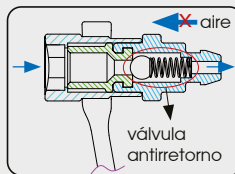

La válvula antirretorno integrada en la llave impide que el aire vuelva a fluir hacia el sistema de frenos.



Para usar sobre todo los estribos de frenos de vehículo, SUV, furgoneta o motocicleta.



Llave y vaso combinados para facilitar el aflojamiento y el apriete.



Tubo de silicona resistente a los líquidos ácidos y alcalinos, a la corrosión, al desgaste y a las temperaturas extremas.





5  
PZAS

0.587

**9BC4A05MP** 1/2" 49€<sup>B</sup>

**JUEGO DE VASOS PARA PINZAS DE FRENOS**

Vasos para pinzas de frenos para los vehículos Volkswagen, Audi et Porsche (VAG).

Vasos 10 dientes: Ø 11.5 mm, Ø 15 mm, Ø 20 mm.

Vasos 7 dientes: Ø 14 mm, Ø 22 mm.

Contiene	Número de dientes	Ø (mm)	Marca y tipo de vehículo
9BC42A11	10 dientes	11.5	Porsche
9BC42A15	10 dientes	15	Audi Q7, S8 e Porsche Macan, Cayenne, Cayman
9BC42A20	10 dientes	20	Audi A8, S6 e Porsche Cayenne
9BC41A14	7 dientes	14	Audi Q7, S4
9BC41A22	7 dientes	22	Audi S5



2  
AÑOS  
GARANTÍA

1.05

**9TV14020** 169€<sup>B</sup>

**SANGRADOR DE FRENOS NEUMÁTICOS**

Herramienta neumática con liberación por la empuñadura.

Rápido y fácil de usar. Sistema de reducción de ruido.

Para drenar el líquido de frenos sin fugas.

Con una manguera de silicona de 1 metro y un adaptador universal de goma.

Capacidad (L)	Presión de aire (PSI)	Entrada de aire (pulgadas)	Temperatura de funcionamiento (°C)
2	40~170	1/4"	-19°C~60°C

**9TV14020**

2  
AÑOS  
GARANTÍA

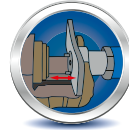

Más espacio de trabajo



Magnético

1.35

**9BC251A01** 96€<sup>B</sup>

**SEPARADOR DE PISTONES PARA FRENOS NEUMÁTICOS**

Más espacio de trabajo. Version slim. Diseñado para facilitar el cambio de discos de freno. La herramienta se puede girar hacia la izquierda y hacia la derecha, adecuada para pistones de rosca normal e inversa.



31  
PZAS



4.87

**9BC23** 219€<sup>B</sup>

**COFRE SEPARADOR DE PISTONES PRESIÓN/ROTACIÓN**

Diseñado para la rotación del pistón en el estribo que permite poner nuevas pastillas. Previene los daños del pistón y del estribo.

CONTIENE:

- 21 adaptadores de pistón
- 3 soportes de refuerzo
- 1 cuadrado conductor rotativo para estribo 3/8" (derecha)
- 1 cuadrado conductor rotativo para estribo 3/8" (izquierda)
- 2 llaves macho hexagonales : 7, 8 mm
- 2 punzones : 5.5 - 6 mm
- 1 vaso con punta hexagonal 3/8" 12 mm

Compatible con BMW, Ford, VW, Audi, Porsche, Saab, Opel, Volvo, Jaguar, Citroën, Peugeot, Renault, Vauxhall, Lancia, Alfa Romeo, Fiat, Nissan, Honda, Subaru, Toyota, Mitsubishi.

## CARROCERÍA

9CF120

31 €<sup>B</sup>

9CF110

31 €<sup>B</sup>

9CF210

27 €<sup>B</sup>

9CF241

24 €<sup>B</sup>

9CF132

27 €<sup>B</sup>

9CF240

28 €<sup>B</sup>

9CF220

27 €<sup>B</sup>

9CF230

24 €<sup>B</sup>



7  
PZAS

430 x 350 x 95 mm

9CF107

222 €<sup>B</sup>

### MALETÍN CARROCERÍA

Contiene

7.5

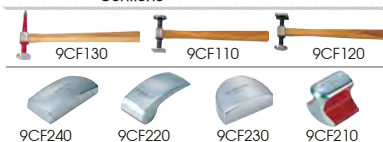

Productos que NO entran en la garantía comercial.



3.5

9CH212

199 €<sup>B</sup>

### DESABOLLADOR NEUMÁTICO

- Masa de inercia de 1.36 kg
- 2 ventosas (120 y 150mm)
- Válvula de cierre de latón
- Enchufe neumático 1/4"
- Flexible de 325 mm.
- Escape de aire por el mango
- Presión de aire en trabajo: 6,3 bar
- Peso: 3,5 kg

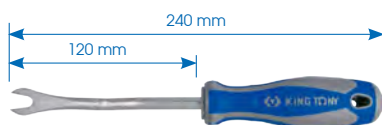

43280212

5,20 €<sup>B</sup>

### GANCHO PARA REFUERZOS DE PUERTA

Permite desmontar los refuerzos de la puerta sin deteriorarlos.

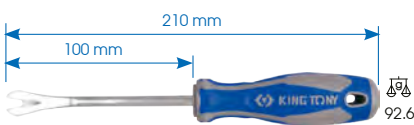

48280180

9,40 €<sup>B</sup>

### GANCHO PARA REFUERZOS DE PUERTA

Permite desmontar los refuerzos de la puerta sin deteriorarlos.

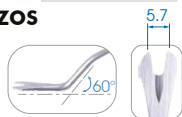

6  
PZAS

9CI016

30 €<sup>B</sup>

### JUEGO DE GANCHOS PARA REFUERZOS DE PUERTA

Ideal para las empuñaduras interiores de las puertas, refuerzos de salpicadero. Perfil fino. Permite quitar fácilmente los refuerzos de puertas.



1050 x 650 mm

520

9TP22

40 €<sup>B</sup>

### FUNDA DE PROTECCIÓN PARA ALETAS - 3 VENTOSAS

Protección contra rayaduras, golpes y suciedad. Resistente, acolchonado y con los bordes reforzados. Ventosas que permiten un agarre óptimo en materiales de aleación de aluminio. Banda magnética integrada en la protección para un mejor agarre.



2 PZAS

**9CJ72** 54 €<sup>B</sup>

**JUEGO DE RASCADORES DE CARBURO DE TUNGSTENO**

La punta de la hoja está hecha de carburo de tungsteno, lo que la hace extremadamente dura y duradera. Elimina depósitos de carbono residuales, marcas de óxido o residuos de silicona de la superficie de objetos, como silicona desgastada en cárteres de aceite, colectores de escape o pinzas de freno. Incluye funda protectora de la punta de la cuchilla.



**New**

✓ Disponible en marzo

10 PZAS

**9CJ61C1** 16 €<sup>B</sup>

**RASCADOR MULTIFUNCIÓN**

Diseñado para raspar rápidamente etiquetas, precintos, pintura y residuos de vidrio o metal. 4 cuchillas de acero SK5 de alta calidad. 5 cuchillas de plástico POM. Admite todas las hojas estándar de un solo filo. Mango ergonómico de PP+TPR.



3 PZAS

**9CJ013** 29 €<sup>B</sup>

**JUEGO DE RASCADORES PLANOS PARA EMPLASTECER**

3 rascadores planos ancho de 32 a 76 mm. Largo total: 218 mm.



3 PZAS

**9CJ023** 33 €<sup>B</sup>

**JUEGO DE RASCADORES REFORZADOS**

3 rascadores reforzados ancho de 32 a 50 mm y 1 acodado. Zona de golpe metálica. Largo total: 218 mm.



3 PZAS

**9CJ033** 23 €<sup>B</sup>

**JUEGO DE RASCADORES ESPECIAL PUNTO DE SOLDADURA**

3 rascadores especiales para puntos de soldadura ancho de 12 a 19 mm. Largo total: 168 / 218 mm.



149

**43240115Y1** 7,50 €<sup>B</sup>

**RASCADOR PARA JUNTAS**

Quite las juntas antiguas con mayor facilidad y rapidez.



241

**9TC101** 24 €<sup>B</sup>

**PINZA PARA TAPICERÍA DE PUERTAS**

Para retirar los clips de los paneles de la puerta. Sistema anti pellizcos.



580 x 350 x 170 mm

2 AÑOS GARANTÍA

17

**9TY120040A** 269 €<sup>B</sup>

**GATO DE CARROCERO - 4 TONELADAS**

Bomba de mano 4 toneladas con flexible hidráulico. Extensión hidráulica: 82, 125, 215, 418, 495 mm. Ariete separador. Ariete de empuje. Juego de puntas para chapa.



820 x 435 x 170 mm

31

**9TY12010AB 10T** 386 €<sup>B</sup>

**GATO DE CARROCERO - 10 TONELADAS**

Bomba de mano 10 toneladas con flexible hidráulico. Extensión hidráulica: 127, 250, 456, 685 mm. Ariete separador. Ariete de empuje. Juego de puntas para chapa.

# HIDRÁULICA - ELEVACIÓN

## RECOGEDOR DE ACEITE



**9TVP180AB**

572 €<sup>D</sup>

### RECOGEDOR DE ACEITE

2 modos de drenaje:

- 1. Succión directa: rápida, a través del pozo indicador. Después de una puesta en marcha sin tener que montar el vehículo sobre un puente y sin desmontar el cárter de aceite.

Depósito de análisis de plexiglás con escala graduada, diseñado para facilitar la visualización del estado del aceite extraído y el volumen (9 L).

- 2. Por gravedad (debajo de un elevador o foso de inspección) : Práctico, gracias a la gran dimensión del embudo de recogida de aceite y a que es regulable en altura.

■ Presión de aire (bar) : 6 ~ 8

	Capacidad de depósito (litros)	Altura mínima (mm)	Altura máxima (mm)	kg
<b>9TVP180AB</b>	80 L	1/4"	40-60°C	26.1

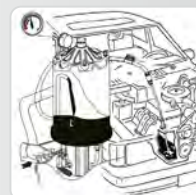

## PALANCA UNIVERSAL



**9BH1000**

209 €<sup>D</sup>

### PALANCA DE TRACCIÓN EN TREN DELANTERO

Evita el desmontaje de las rótulas o del triángulo de suspensión.

Montaje manual, sencillo, rápido y seguro.

Adecuado para todos los coches y vehículos comerciales ligeros.

	Capacidad (kg)	Altura mínima (mm)	Largo (mm)	Anchura (mm)	kg
<b>9BH1000</b>	200	300	1000	130	6

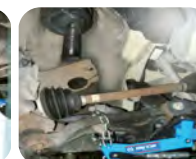

## SOPORTE PARA MOTOR



■ Equilibra la carga para facilitar la manipulación y posicionamiento del motor.

**9TY621AB**

46 €<sup>B</sup>

### EQUILIBRADOR DE CARGA

Ajuste del equilibrio mediante manivela. Se suministra con 4 cadenas de soporte. Compatible con las grúas de taller 9HYGR11 / 9HYGR55 / 9HYGR20.

	Capacidad (kg)	Longitud (mm)	kg
<b>9TY621AB</b>	680	400	5.5



**9TY135150AB**

253€<sup>B</sup>

**SOPORTE PARA MOTOR**

Para intervenciones en motores desmontados. 4 garras ajustables (separación y rotación). Soporte orientable 360°. 5 ruedas de las cuales 3 son direccionales y 2 tienen frenos.

	Capacidad (kg)	Altura mínima (mm)	Largo (mm)	Anchura (mm)	kg
9TY135150AB	680	880	870	825	33



**9TY61105AB**

159€<sup>B</sup>

**SOPORTE PUENTE PARA MOTOR**

Permite sujetar los motores y cajas de cambios durante el desmontaje. Pies orientables. Almohadillas de caucho antideslizantes.

	Capacidad (kg)	Longitud (mm)	kg
9TY61105AB	500 kg	1500	22

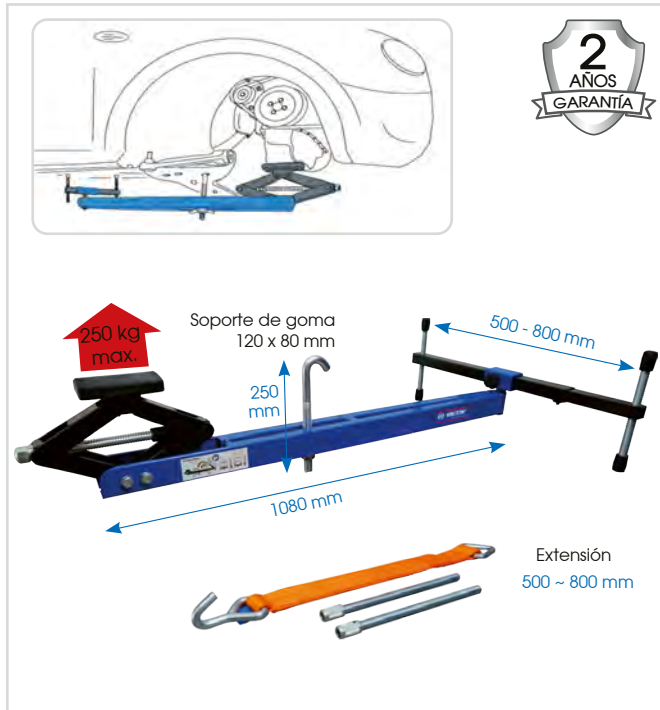

**9BJ2070**

519€<sup>D</sup>

**SOPORTE PUENTE PARA MOTOR**

Permite sujetar los motores y cajas de cambios durante el mantenimiento de los coches y de los utilitarios.

	Capacidad (kg)	Altura (mm)	Largo (mm)	Anchura (mm)	kg
9BJ2070	250	120 ~ 260	1080	500	12



**9TYVS1**

398€<sup>D</sup>

**SOPORTE DE APOYO**

Diseñado para facilitar el desmontaje y el posicionamiento de la caja de cambios en coches y vehículos comerciales ligeros.

	Capacidad (kg)	Altura (mm)	Largo (mm)	Anchura (mm)	kg
9TYVS1	150	300	450	310	8

EXCELLENCE  
SERIES  
★★★★

Estructura  
GARANTIZADA  
10 AÑOS  
Sistema  
hidráulico  
GARANTIZADO  
3 AÑOS



9HYGR55  
9HYGR11



Plegada, ocupa un mínimo de espacio en el taller.



9HYGR20



5 posiciones = 5 capacidades

	Posición N°1 (kg)	Posición N°2 (kg)	Posición N°3 (kg)	Posición N°4 (kg)	Posición N°5 (kg)
9HYGR55	550	500	450	400	350
9HYGR11	1100	1000	900	800	700
9HYGR20	2000	1900	1800	1700	1600

## 9HYGR

### GRÚA DE TALLER HIDRÁULICA

- Plegable en pocos segundos para un almacenaje rápido y fácil.
- Brazo extensible con gran capacidad de elevación, incluso en la última posición.
- Varilla de pistón y pistón de bomba con recubrimiento de cromo duro que garantizan una larga vida útil.
- Válvula de seguridad integrada que previene sobrecargas.
- Ruedas traseras pivotantes a 360° para garantizar la manejabilidad de la grúa, incluso con carga máx.
- Sistema hombre muerto manual.

	Capacidad (Toneladas)	Altura mínima (mm)	Altura máxima (mm)	Brazos de extracción (mm)	Altura marco (mm)	Longitud marco (mm)	Largo interior (mm)	Largo del cuadro (mm)	Altura (mm)	kg	
9HYGR55	0.55 T	2020	2340	955 - 1375	125	1420	955	1080	1520	75	1288 €
9HYGR11	1.10 T	2020	2340	955 - 1375	125	1420	985	1110	1520	95	1525 €
9HYGR20	2.00 T	2340	2630	1210	160	1750	840	1020	1850	250	4990 €

Oferta válida del 01/01/2025 al 31/12/2025. Precio recomendado de venta al público en euros sin IVA. Fotos no contractuales.

**EXCELLENCE SERIES**  
★★★★



**9HYCM5**

2240€<sup>D</sup>

**CARRO PORTA RUEDAS HIDRÁULICO**

Elevador flexible y ergonómico para cambiar ruedas y conjuntos de frenos. Ideal para elevar tambores de frenos, depósitos de combustible, cajas de herramientas, etc.



Brazos elevadores con rodamientos para una cómoda rotación de la rueda en posición correcta.

Bomba con pedal que deja ambas manos libres para trabajar



	Capacidad (Toneladas)	Largo (mm)	Ancho (mm)	Altura (mm)	Longitud rodillo/horca (mm)	Distancia entre los rodillos (mm)	Altura de elevación (mm)	Tamaño de la rueda (mm)	Brazo de grúa 9HYCMA1	kg
<b>9HYCM5</b>	0.5 T	870	990	1180	415 / 600	260 - 710	710	Ø 270-1300	○	100

Ilustración con brazos de grúa (accesorio)

○ Opcional

**EXCELLENCE SERIES**  
★★★★



**9HYCM15V2**

5129€<sup>D</sup>

**CARRO PORTA RUEDAS HIDRÁULICO**



**MANIVELA**

Sistema de rotación de la rueda simplificado gracias a su manivela. Al girar el rodillo permite la rotación de la rueda.

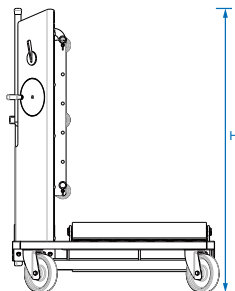
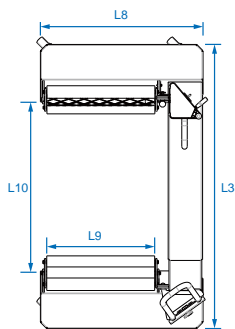

Manejo óptimo gracias a las 4 ruedas giratorias



Palanca con sistema hidráulico para controlar la distancia de los rodillos de modo a levantar o bajar la rueda



Rodillo con estrías para girar la rueda



Sistema de retención y alineación de la rueda



Seguridad óptima para el usuario



Soporte de seguridad para una fijación rápida de la rueda durante el transporte

	Capacidad (Toneladas)	Largo L8 (mm)	Ancho L3 (mm)	Altura H5 (mm)	Longitud rodillo L9 (mm)	Distancia entre rodillo L10 (mm)	Diámetro rodillo (mm)	Para ruedas con diámetro (mm)	kg
<b>9HYCM15V2</b>	1.5 T	1040	1635~2375	1455	690	900 - 1650	80	Ø 1000 - 2400	225

Oferta válida del 01/01/2025 al 31/12/2025. Precio recomendado de venta al público en euros sin IVA. Fotos no contractuales.

PRO SERIES  
★★★★

Estructura GARANTIZADA 5 AÑOS  
Sistema hidráulico GARANTIZADO 2 AÑOS



- Elevación hidráulica mediante pedal y descenso progresivo mediante joystick para detener la plataforma a la altura deseada.
- Fácil de mover gracias a su aro cromado.
- Fabricado en acero de alta resistencia.
- Válvula de seguridad integrada en el cilindro hidráulico para evitar sobrecargas.

**9TYC11**

**MESA ELEVADORA HIDRÁULICA DE TIJERA SIMPLE**

	Capacidad (kg)	Altura mínima (mm)	Altura máxima (mm)		
9TYC11015AB	150	225	740	44	335 € <sup>D</sup>
9TYC11050AB	500	340	900	87	505 € <sup>D</sup>
9TYC11100AB	1000	420	1000	115	1 099 € <sup>D</sup>

New

**9TYC12**

**MESA ELEVADORA HIDRÁULICA DE TIJERA DOBLE**

622 € <sup>D</sup>

	Capacidad (kg)	Altura mínima (mm)	Altura máxima (mm)	
9TYC12035AB	350	350	1300	105



1,5 t



Pedal "Quick-lift"

Ruedas silenciosas

**9TYC1101500**

2 049 € <sup>D</sup>

**MESA ELEVADORA HIDRÁULICA**

Permite elevar, bajar y, eventualmente, desplazar en distancias cortas, cargas de hasta 1,5 toneladas. Pedal de bomba "Quick-lift" para una maniobra rápida.

	Capacidad (Toneladas)	Altura mínima (mm)	Altura máxima (mm)	
9TYC1101500	1.5 T	210	880	130





Estabilice siempre el vehículo con caballetes antes de realizar cualquier operación debajo. Está prohibido permanecer dentro, encima o debajo del vehículo cuando se levanta o se sujeta con un gato.

## GATOS DE FOSO



### 9TYN1436

#### GATO DE FOSO

Mango de plástico de doble velocidad.  
Pedal con revestimiento de caucho.  
Protección anti-polvo.  
Bomba hidráulica doble.  
Rueda de fibra de vidrio y nylon.  
Cilindro del pistón cromado para una vida más larga.  
Válvula de sobrecarga de seguridad.

	Capacidad (kg)	Altura mínima (mm)	Altura máxima (mm)	kg		
9TYN143603AB	300	1140	2000	28.1	436 €	D
9TYN143606AB	600	1146	1986	34.8	510 €	D
9TYN143610AB	1000	1170	2010	39.8	558 €	D



### 9TY145

533 €<sup>D</sup>

#### GATO DE FOSO

Empuñaduras para facilitar el ajuste.  
Válvula de sobrecarga de seguridad.  
Pedal hidráulico.  
Estructura de acero reforzado.  
Ruedas de nylon.

	Capacidad (kg)	Altura mínima (mm)	Altura máxima (mm)	kg
9TY145015AB	1500	1130	1915	55.5



Oferta válida del 01/01/2025 al 31/12/2025. Precio recomendado de venta al público en euros sin IVA. Fotos no contractuales.



Establezca siempre el vehículo con caballetes antes de realizar cualquier operación debajo. Está prohibido permanecer dentro, encima o debajo del vehículo cuando se levanta o se sujeta con un gato.

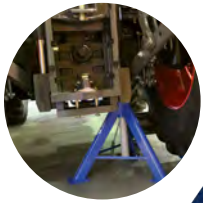

**9TY321**

**JUEGOS DE 2 CABALLETES ESTÁNDARES**

Su estructura resistente garantiza la máxima estabilidad y una larga vida. Ajustable a varias alturas.

	Capacidad (Toneladas)	Altura mínima (mm)	Altura máxima (mm)	Peso del juego (kg)	
9TY32103A	3 T	375	555	9	67 € <sup>D</sup>
9TY32105A	5 T	395	665	10	195 € <sup>D</sup>

**9TY332**

**JUEGOS DE 2 CABALLETES REGULABLES**

Caballote fácil de usar. Su tornillo permite un ajuste rápido y preciso de la altura. Adecuado para casi todos los tipos de vehículos. Su estructura resistente garantiza la máxima estabilidad y una larga vida.

	Capacidad (Toneladas)	Altura mínima (mm)	Altura máxima (mm)	Peso del juego (kg)	
9TY33220AB	20 T	420	600	50.8	658 € <sup>D</sup>
9TY33221AB	20 T	665	1090	75	870 € <sup>D</sup>



- Robusto acero soldado para mayor seguridad y resistencia.
- Ajustable a varias alturas.



**9TYE342**

**JUEGO DE 2 CABALLETES ESTÁNDARES DE CREMALLERA**

	Capacidad (Toneladas)	Altura mínima (mm)	Altura máxima (mm)	Peso del juego (kg)	
9TYE34203AB	3 T	291	430	6.8	59 € <sup>D</sup>
9TYE34206AB	6 T	390	610	12.6	129 € <sup>D</sup>

**9TYE351**

**JUEGO DE 2 CABALLETES ESTÁNDARES DE BASE CUADRADA**

	Capacidad (Toneladas)	Altura mínima (mm)	Altura máxima (mm)	Peso del juego (kg)	
9TYE35112AB	12 T	300	450	40.4	253 € <sup>D</sup>
9TYE35122AB	22 T	311	505	64	279 € <sup>D</sup>

CARRETILLAS DE MANUTENCIÓN

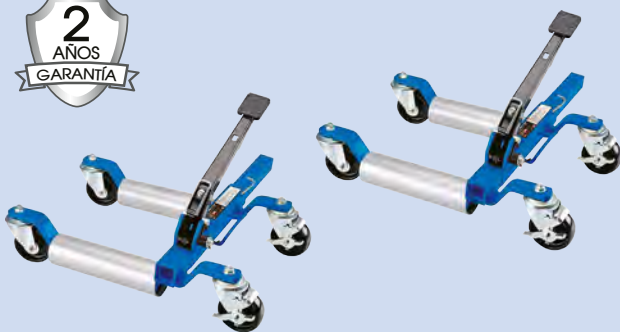

**9TYE722AB**

348 €<sup>D</sup>

**JUEGO DE 2 CARROS DESPLAZAMIENTO**

El vehículo se eleva mediante un pedal. 4 ruedas giratorias para facilitar el desplazamiento en todas las direcciones.

	Capacidad (kg)	Distancia entre los rodillos (mm)	Ancho máximo del neumático (pulgadas - mm)	Peso del juego (kg)
9TYE722AB	680/carro	270 - 650	13" - 330 mm	32.2

## GATOS DE BOTELLA



### 9TY111

#### GATOS HIDRÁULICOS DE BOTELLA CON CILINDRO DE 1 FASE Y PROLONGADOR DE EJE

Todos los modelos se pueden utilizar entre -20°C y 70°C. También se puede utilizar como cilindro de presión en posición horizontal. El pistón de la bomba debe colocarse debajo del gato. Válvula de seguridad integrada. Mango galvanizado. Con prolongador en la columna para una explotación óptima de la longitud de carrera.

	Capacidad (Toneladas)	Altura mínima (mm)	Altura máxima (mm)	Carga hidráulica (mm)	Columna (mm)		
9TY111035A	3,5 T	172	372	112	88	3,7	69 € B
9TY11105A	5 T	212	468	146	110	4,9	77 € B
9TY11110A	10 T	220	483	148	115	7,3	111 € B
9TY11115A	15 T	231	498	154	113	9,8	135 € B
9TY11120A	20 T	241	521	165	115	13,1	166 € B
9TY11130A	30 T	244	510	266	110	47,3	183 € B

New

## GATOS NEUMÁTICOS



### 9TYN24302AB

#### GATO NEUMÁTICO MANGO CORTO DE 2 NIVELES (2 T)

Presión de alimentación (Bar) : 7 ~ 10

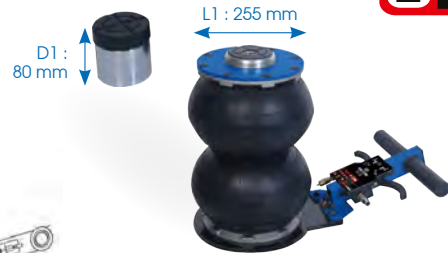
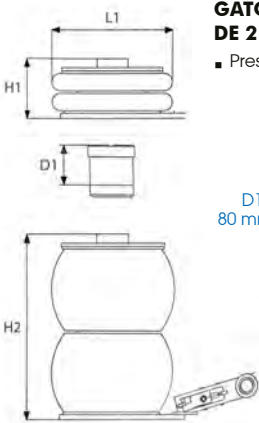

2 TONELADAS

### 9TYN24102AB

#### GATO NEUMÁTICO MANGO LARGO DE 2 NIVELES (2 T)

Presión de alimentación (Bar) : 7 ~ 10



Mango largo  
2 GATILLOS:  
1 para subir y 1 para bajar

Los gatos de aire son compactos, fácil de usar y ofrecen una gran amplitud de subida.

### 9TYN24402AB

#### GATO NEUMÁTICO DE MANGO CORTO DE 3 NIVELES (2 T)

Presión de alimentación (Bar) : 7 ~ 10

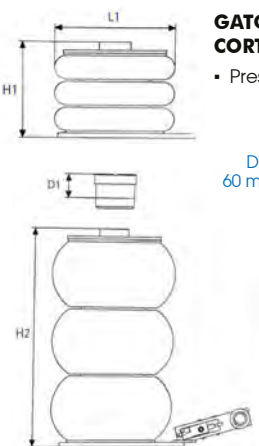

2 TONELADAS

### 9TYN24202AB

#### GATO NEUMÁTICO DE MANGO LARGO DE 3 NIVELES (2 T)

Presión de alimentación (Bar) : 7 ~ 10



Mango largo  
2 GATILLOS:  
1 para subir y 1 para bajar

	Capacidad (Toneladas)	Altura mínima H1 (mm)	Altura máxima H2 (mm)	Altura de carga (mm)	Altura máxima (mm)		
--	-----------------------	-----------------------	-----------------------	----------------------	--------------------	--	--

9TYN24102AB	2 T	115	350	235	430	18	681 € D
9TYN24202AB	2 T	200	500	300	560	19,84	712 € D
9TYN24302AB	2 T	115	350	235	430	15	609 € D
9TYN24402AB	2 T	200	500	300	560	17	700 € D

- Valvula de seguridad.
- Bolsas de aire en tela 4ply.
- Anillo guía en el cilindro para un funcionamiento suave y duradero.
- Interruptor de parón automático con diseño ergonómico, seguro y fácil de usar.

# GATOS CON RUEDAS

**EXCELLENCE SERIES**  
★★★★

Estructura GARANTIZADA 10 AÑOS  
Sistema hidráulico GARANTIZADO 3 AÑOS



**2 TONELADAS**

OPCIONAL 9HYCR1

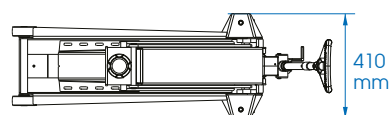
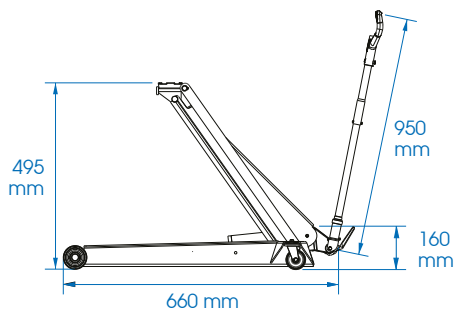

Pedal "Quick-lift"



Ruedas silenciosas

**9HYCR2**

600€<sup>D</sup>

## GATO HIDRÁULICO DE CARRETILLA CON ALTO LEVANTAMIENTO

Ideal para coches y utilitarios. Muy bajo, altura mínima de solo 80 mm. Marco ancho y robusto de acero de alta resistencia. Con pedal de levantamiento rápido. Control preciso y sin peligro en el descenso. Sistema hombre muerto manual que ofrece seguridad óptima en el descenso. Válvula de seguridad integrada que previene sobrecargas. Ruedas silenciosas con ranura central de poliuretano para una protección óptima del suelo. Mango ergonómico.

	Capacidad (Toneladas)	Altura mínima (mm)	Altura máxima (mm)	Longitud Marco (mm)	Longitud Mango (mm)	Altura Marco (mm)	Anchura (mm)	kg
<b>9HYCR2</b>	2 T	80	495	660	950	160	410	31

**New**



**9TYE13303AB**

647€<sup>D</sup>

## GATO TODOTERRENO

Adecuado para vehículos todoterreno, furgonetas y camiones medianos.

**+ Todo terreno. Resistencia reforzada.**

**3 TONELADAS**



La extensión se puede montar o desmontar rápida y fácilmente, lo que hace que el gato sea muy versátil sin perder tiempo.



	Capacidad (Toneladas)	Altura mínima (mm)	Altura máxima (mm)	kg
<b>9TYE13303AB</b>	3 T	165	730	29





### 9TYN13

#### GATO HIDRÁULICO DE CARRETILLA

Mango con dispositivo «hombre-muerto» (mango de retorno automático).  
Mango ergonómico de 2 manos.

9TYN13302AB

**2**  
TONELADAS

9TYN13303AB

**3**  
TONELADAS



	Capacidad (Toneladas)	Altura mínima (mm)	Altura máxima (mm)	kg
--	-----------------------	--------------------	--------------------	----

9TYN13302AB	2 T	75	500	32.9	379 € D
9TYN13303AB	3 T	95	515	39.5	419 € D



### 9TYN13402AB

423 € D

#### GATO HIDRÁULICO DE CARRETILLA

Perfil bajo para todos tipos de vehículos.  
Mango con dispositivo «hombre-muerto» (mango de retorno automático).

**2** TONELADAS



	Capacidad (Toneladas)	Altura mínima (mm)	Altura máxima (mm)	kg
--	-----------------------	--------------------	--------------------	----

9TYN13402AB	2 T	75	530	42.2
-------------	-----	----	-----	------

**New**



### 9TYE13325AB

239 € D

#### GATO HIDRÁULICO DE CARRETILLA

Gato rodante de perfil bajo para vehículos con poca distancia al suelo.  
Empuñadura antideslizante y ergonómica.

**2.5** TONELADAS



Doble bomba para una elevación más rápida



75 mm

	Capacidad (Toneladas)	Altura mínima (mm)	Altura máxima (mm)	kg
--	-----------------------	--------------------	--------------------	----

9TYE13120AB	2.5 T	75	510	30.5
-------------	-------	----	-----	------



### 9TYN13102AB

559 € D

#### GATO HIDRÁULICO DE CARRETILLA

Mango con dispositivo «hombre-muerto» (mango de retorno automático).  
Mango ergonómico de 2 manos.

**2** TONELADAS



	Capacidad (Toneladas)	Altura mínima (mm)	Altura máxima (mm)	kg
--	-----------------------	--------------------	--------------------	----

9TYN13102AB	2 T	85	780	54.18
-------------	-----	----	-----	-------

### 9TYE13110AB

1133 € D

#### GATO HIDRÁULICO DE CARRETILLA

Regulador de velocidad.  
Válvula de seguridad para evitar sobrecargas.

**10** TONELADAS



	Capacidad (Toneladas)	Altura mínima (mm)	Altura máxima (mm)	kg
--	-----------------------	--------------------	--------------------	----

9TYE13110AB	10 T	160	560	133
-------------	------	-----	-----	-----



### 9TYE13120AB

2908 € D

#### GATO HIDRÁULICO DE CARRETILLA

Regulador de velocidad.  
Válvula de seguridad para evitar sobrecargas.

**20** TONELADAS



	Capacidad (Toneladas)	Altura mínima (mm)	Altura máxima (mm)	kg
--	-----------------------	--------------------	--------------------	----

9TYE13120AB	20 T	185	620	241
-------------	------	-----	-----	-----

EXCELLENCE SERIES

Estructura GARANTIZADA 10 AÑOS  
Sistema Hidráulico GARANTIZADO 3 AÑOS

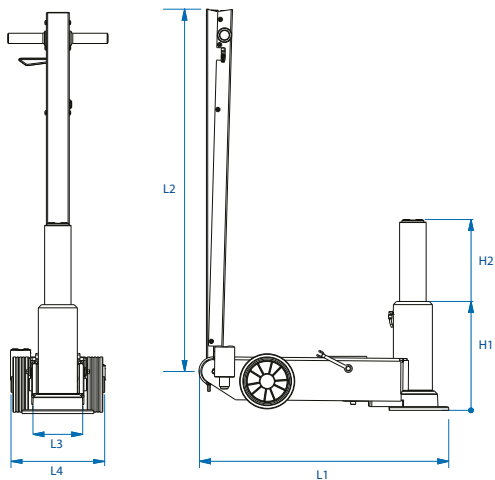

25 TONELADAS



1 fase

9HYCH125H

4 638 €<sup>D</sup>

### GATO HIDRONEUMÁTICO DE UNA FASE

- Mango inclinable
- Protección de las fundas neumáticas en el mango
- Protección integral del sistema hidro neumático
- Pistón con recubrimiento de cromo duro que garantiza una larga vida útil
- Sistema hombre muerto que ofrece seguridad óptima en la elevación y el descenso
- Válvula de seguridad integrada que previene sobrecargas
- Incluidas 2 extensiones (50/100 mm)



Extensión 250 mm



OPCIONAL 9HYCHR25

Pistón de Ø 145 mm



OPCIONAL 9HYCHOP1

Capacidad (Toneladas)	Altura mínima H1 (mm)	Altura máxima H2 (mm)	Longitud cuadro L1 (mm)	Longitud mango L2 (mm)	Anchura con ruedas L4 (mm)	Anchura L3 (mm)	Presión de alimentación (bar)	Consumo de aire (L/min)	kg	Extensión 9HYCHR25	Pistón 9HYCHOP1
25 T	360	610	820	1160	310	230	8 - 10	350	71	○	○

○ Opcional



9HYCHP225

2 950 €<sup>D</sup>

### GATO OLEO-NEUMÁTICO PORTÁTIL

- Altura mínima muy baja: solo 160 mm, y ligero solo 28 kg
- Diseño cómodo sin tubos sueltos, sin mango ni válvulas sueltas
- Fácil de utilizar con el mango, la empuñadura de transporte y la válvula de mando integrados en una misma y única función
- Pistón con recubrimiento de cromo duro que garantiza una larga vida útil
- Sistema hombre muerto que ofrece seguridad óptima en la elevación y el descenso
- Válvula de seguridad integrada que previene sobrecargas
- Incluidas 2 extensiones (50/100 mm)



10/25

TONELADAS

Extensión 250 mm



OPCIONAL 9HYCHR25

Pistón de Ø 145 mm



OPCIONAL 9HYCHOP1



PARA TALLERES MÓVILES

28 kg



Capacidad (Toneladas)	Altura mínima (mm)	Altura máxima (mm)	Longitud cuadro (mm)	Longitud mango (mm)	Anchura con ruedas (mm)	Anchura (mm)	Presión de alimentación (bar)	Consumo de aire (L/min)	kg	Extensión 9HYCHR25	Pistón 9HYCHOP1
25 / 10 T	160	235 / 320	535	550	290	225	8 - 10	350	28	○	○

○ Opcional

PRO  
SERIES

Estructura  
GARANTIZADA  
5 AÑOS  
Sistema  
hidráulico  
GARANTIZADO  
2 AÑOS



## 9TYN231

### GATOS HIDRONEUMÁTICOS DE UNA FASE

Válvula de desaceleración.

Válvula de seguridad contra sobrecargas.

Interruptor de parón automático para un trabajo más seguro.

Incluidas 2 extensiones (9TYN23130AB : 45 y 100 mm, 9TYN23160AB : 100 y 200 mm).

- Presión de alimentación (Bar) : 9 ~ 12

30 TONELADAS



9TYN23130AB

60 TONELADAS



9TYN23160AB

	Capacidad (Toneladas)	Altura mínima (mm)	Altura máxima (mm)	kg	
9TYN23130AB	30 T	360	772	86	2 476 € <sup>D</sup>
9TYN23160AB	60 T	420	1031	126	2 997 € <sup>D</sup>



## 9TYN23

### GATOS HIDRONEUMÁTICOS DE 2 FASES

Válvula de desaceleración.

Válvula de seguridad contra sobrecargas.

Interruptor de parón automático para un trabajo más seguro.

Incluidas 2 extensiones (45 y 75 mm).

- Presión de alimentación (Bar) : 9 ~ 12

10/25 TONELADAS



9TYN23125AB

25/50 TONELADAS



9TYN23150AB

40/60 TONELADAS



9TYN23260AB

	Capacidad (Toneladas)	Altura mínima (mm)	Altura máxima (mm)	kg	
9TYN23125AB	10/25 T	183	494	49	1 929 € <sup>D</sup>
9TYN23150AB	25/50 T	215	564	67	2 097 € <sup>D</sup>
9TYN23260AB	40/60 T	220	580	82	2 386 € <sup>D</sup>



## 9TYN23250AB

2 112 €<sup>D</sup>

### GATO HIDRONEUMÁTICO DE 3 FASES

Válvula de desaceleración.

Válvula de seguridad contra sobrecargas.

Interruptor de parón automático para un trabajo más seguro.

Incluidas 2 extensiones (45 y 75 mm).

- Presión de alimentación (Bar) : 9 ~ 12

15/30/50 TONELADAS



	Capacidad (Toneladas)	Altura mínima (mm)	Altura máxima (mm)	kg
9TYN23250AB	15/30/50 T	150	432	56



## 9TYN23330AB

1 638 €<sup>D</sup>

### GATO OLEO-NEUMÁTICO PORTÁTIL

Ideal para reparación en carretera.

Válvula de desaceleración.

Válvula de seguridad contra sobrecargas.

Incluidas 2 extensiones (45 y 75 mm).

- Presión de alimentación (Bar) : 9 ~ 12

15/30 TONELADAS



	Capacidad (Toneladas)	Altura mínima (mm)	Altura máxima (mm)	kg
9TYN23330AB	15/30 T	150	413	32

# PRENSAS HIDRÁULICAS

**PRO SERIES**  
\*\*\*

Estructura **GARANTIZADA 5 AÑOS**  
Sistema hidráulico **GARANTIZADO 2 AÑOS**

## PRENSAS HIDRAULICAS MANUALES Y NEUMATICAS

Valvula de seguridad.  
Bomba neumática y manual de doble velocidad.  
Acción neumática con pedal.  
Empuñadura articulada para cabrestante.  
Empuñadura y soporte ergonómico.

- Presión de alimentación (Bar) : 9 ~ 12



**9TYN51420AB** 1745 € <sup>D</sup>



**9TYN51430AB** 2230 € <sup>D</sup>

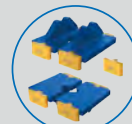

Block en V y configuración a 180°



Bomba deslizable con empuñadura y escala de posicionamiento



Cárter de protección del cabrestante



Soporte de empuñadura del cabrestante



Soporte de empuñadura



Cárter de protección de la polea

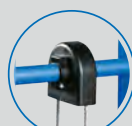

Cárter de protección del cabrestante y de la polea para seguridad de las manos



Tapa anti polvo



**9TYN51450AB** 3089 € <sup>D</sup>



**9TYN514A0AB** 6405 € <sup>D</sup>



Extensión de tornillo



Juego de punzones

Incluido por :  
9TYN51420AB  
9TYN51430AB  
9TYN51450AB

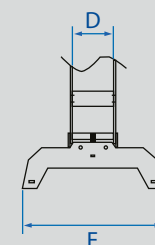
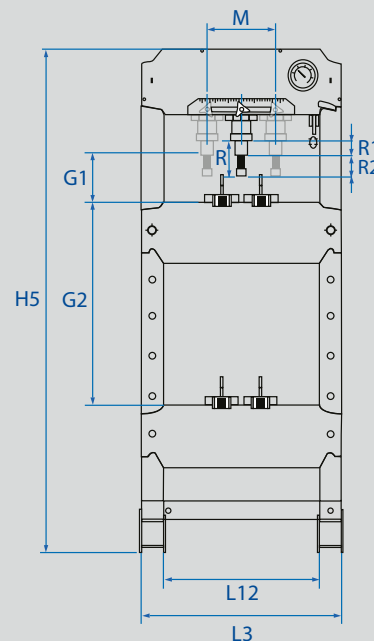

	Capacidad (tonelada)	D (mm)	E (mm)	G1 (mm)	G2 (mm)	R2 (mm)	R1 (mm)	R (mm)	M (mm)	Anchura L3 (mm)	Altura H5 (mm)	Anchura entre los pies L12 (mm)	kg
<b>9TYN51420AB</b>	20 T	152	505	25	850	75	145	220	200	770	1800	600	132
<b>9TYN51430AB</b>	30 T	200	535	130	830	75	145	220	280	930	1900	750	210
<b>9TYN51450AB</b>	50 T	200	535	80	780	75	145	220	280	930	1900	750	249.20
<b>9TYN514A0AB</b>	100 T	280	750	185	855	-	-	300	360	1255	1938	850	677

Oferta válida del 01/01/2025 al 31/12/2025. Precio recomendado de venta al público en euros sin IVA. Fotos no contractuales.





A instalar en el espacio de trabajo.

- Pantalla fabricada en policarbonato con alta resistencia a los golpes.
- Mejora la seguridad de los operadores.



Compatible con



9TYN51420P01A	9TYN51420AB	5	129 €	D
9TYN51430P01A	9TYN51430AB	6	141 €	D
9TYN51450P01A	9TYN51450AB	6	139 €	D
9TYN514AOP01A	9TYN514A0AB	12.75	308 €	D



Instale los pernos fijados al marco de la prensa de la tienda.

3.5

### 9TYN514AOP02A

105 € D

#### KIT DE HERRAMIENTAS DE PRENSA

El juego de pasadores incluye los pasadores con diferentes capacidades de 2t, 3t, 6t, 8t, 10t, 12t, 13t y 15t.

Capacidad (tonelada)	Largo (mm)	Ø (mm)
2 T	60	10
3 T	60	12
6 T	60	16
8 T	85	18
10 T	85	20
12 T	85	22
13 T	110	25
15 T	108	30

Compatible con:

9TYN51420AB / 9TYN51430AB / 9TYN51450AB / 9TYN514A0AB

EXCELLENCE SERIES

Estructura GARANTIZADA 10 AÑOS  
Sistema hidráulico GARANTIZADO 3 AÑOS

Ø 10, 12, 15, 17, 20, 22, 25, 30 mm

OPCIONAL 9HYPA3

OPCIONAL 9HYPP40 9HYPP60 9HYPP100



Mesa de la prensa regulable con cabestrante. Opción de tracción con cadena para el levantamiento / Baja de la bandeja con el gato (9HYP1400).

! Prensa manual con control neumático (máximo 12 bars)



Cilindro de desplazamiento lateral.

KING TONY

40 TONELADAS

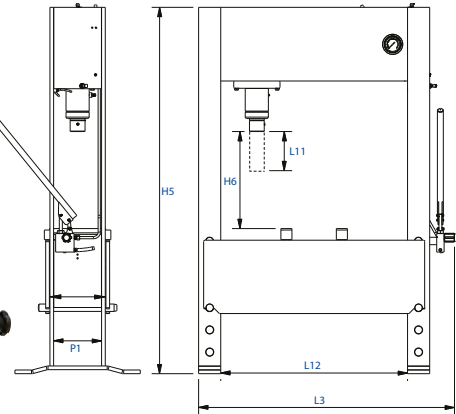

El pedal permite operar el cilindro neumáticamente a gran velocidad para fijar el elemento de trabajo con rapidez y precisión.

### 9HYP40 7314 € D

#### PRENSA HIDRÁULICA MANUAL

- Longitud de carrera de 300 mm para las tareas exigentes
- Incluidos dos bloques en V
- Válvula de seguridad integrada que previene sobrecargas
- Extremo desmontable para poder montar distintos cabezales
- Marco y mesa de acero soldados para garantizar una mayor resistencia

Capacidad (Toneladas)	Largo L3 (mm)	Altura H5 (mm)	Longitud de carrera L11 (mm)	Largo entre las patas L12 (mm)	Profundidad entre las patas P1 (mm)	Distancia entre el suelo H6 (mm)	kg	Cadena de levantamiento 9HYP1400	Kit 9HYPA3	Pantalla protectora 9HYPP-	
9HYP40	40 T	1190	1740	300	850	215	85 - 785	425	○	○	○

○ Opcional



X



**¡Una colaboración de excepción  
combinando calidad e innovación!**

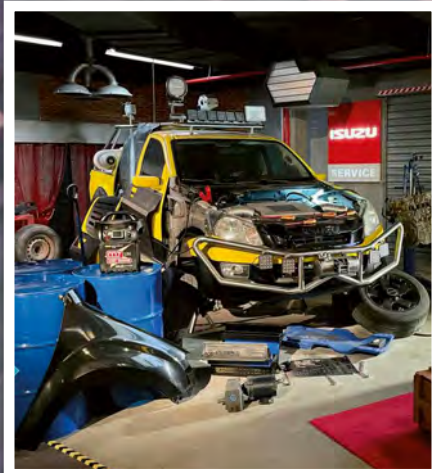

# HA LLEGADO EL NUEVO CATÁLOGO PROMOCIONAL M7.



**2025**  
AUTHENTIC POWER





Soluciones electroportátiles | neumáticas



[catalog.kingtony.eu](http://catalog.kingtony.eu)



 [kingtonyeurope.com](http://kingtonyeurope.com)

 [service-clients@kingtony.eu](mailto:service-clients@kingtony.eu)

 +34 917 335 090

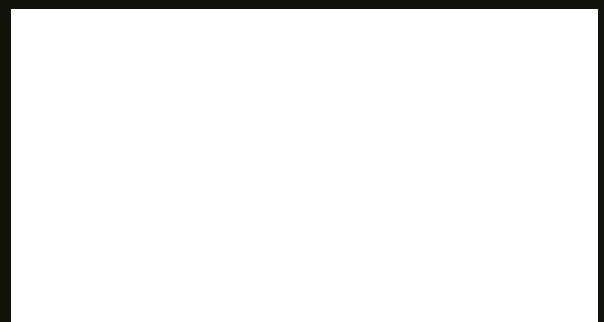

KING TONY Europa SAS con capital de 7 350 000 €. Siren 424 737 138 - FR 26 424 737 138.  
KING TONY se reserva el derecho modificar o borrar referencias sin pre-aviso.